

# New F1 Drill & IDSH insert

F1DR

IDSH

New evolutionary deep hole drill, World first !!  
releasing max. 1.25meters from a pioneer of carbide  
indexable drill manufacturer, YESTOOL Co., Ltd.

- ❖ Designed to use either gun-drill machine or machining center
- ❖ Higher feeding rate 2 times or over than gun-drill
- ❖ Internal coolant and fit IDSH carbide insert
- ❖ Carbide wear parts on flute(optional)
  - Ø8.0~9.5 ⇨ 20xD
  - Ø10.0~11.5 ⇨ 30xD
  - Ø12.0~23.5 ⇨ 50xD
  - Ø24.0~25.0 ⇨ 45xD
  - Ø25.0 or over available max. 1,250mm(OAL)



※ Visit our below website for more test drilling  
(Ø20.0, steel cutting depth 400mm)  
[www.yestool.com](http://www.yestool.com)

cutting speed	S: 2,000 rpm
	f: 0.25mm/rev
	F: 500mm/min



## Optimum quality for your high productivity

Yestool has been providing high quality cutting tools with reasonable prices and wide variety of metal cutting solution.

## Recent new tools

- KRUZ-FSL** : Flange type body to enable anti-vibration
  - KRUZ-FH** : Flange type body with higher helix flute to reduce machine load
  - IDH** : Premium carbide insert with higher helix, single point 140°
  - IDPH** : Premium carbide insert with higher helix, dual point 130°+150°
  - IDFH** : Premium carbide insert with higher helix & flatted bottom point with dual point 140°+170°
  - IDSH** : Special insert for stainless, titanium or exotic material purpose
  - KRUZ "K" series** : Structural machining purpose drill body
- Former DL or SL version will be depleted soon after inventory is consumed



## Expanded special tools

Yestool's capability will exceed your expectations. Engineered special, modification of standard, made to order and special tolerance etc. easily available per customer's requirements. Call your local distributor and enjoy optimum service of qualified distributor.

## Distribution network

Yestool products are being supplied through the most qualified industrial distributors throughout 50 different countries around the world. This select organization will be able to support customers to meet the satisfaction.

**Our goal is to provide the best innovative tool for the job at hand.**  
**Reduce your machining cost by Yestool's solution.**

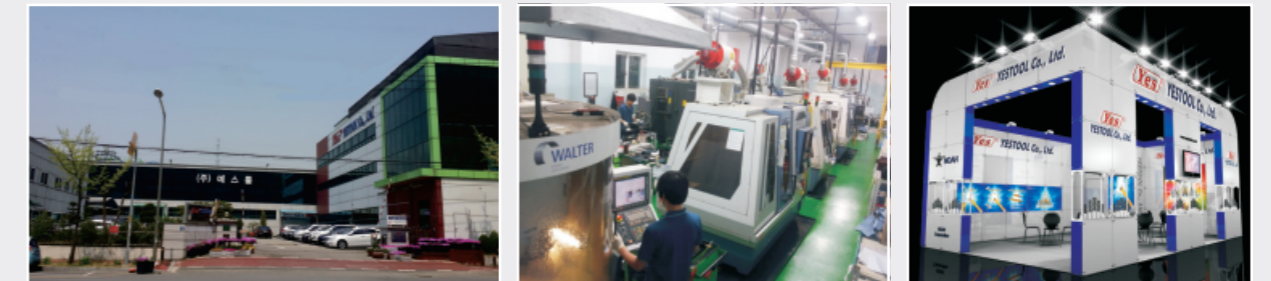

All of our product design is processed by 3D-graphic along with computerized calculation, even more simulation before actual manufacturing tool in CNC machine.

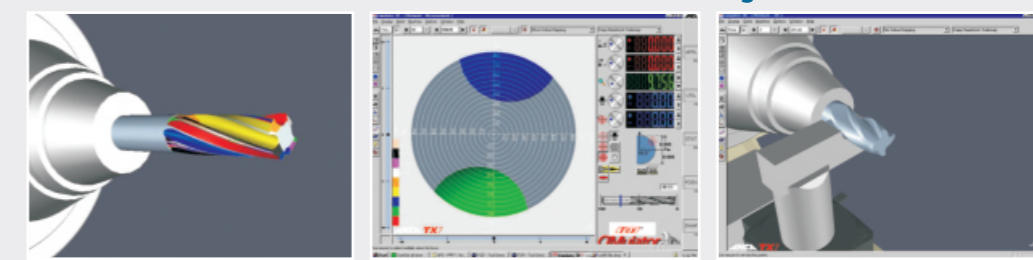





















Model	Description & Available Standard Sizes	Page	Stock
<b>ORDERING</b>	Ordering Information for Yes brand products 주문방법	8	
<b>F1DR</b>	F1 deep hole drill (20xD ~ 50xD) F1 딥홀 드릴	2	○
<b>KRUZ-FSL</b>	KRUZ-FSL Drill Flange Type Bodies (Φ8.0~50.0mm, 3xD, 5xD, 7xD, 10xD) 크루즈-FSL 플랜지드릴 바디	12~17	●
<b>IDP, IDF, ID</b>	IDP, IDF, ID Carbide Drills Insert (Φ8.0~50.4mm) IDP, IDF, ID형 초경 인서트	12~17	●
<b>KRUZ-FH</b>	KRUZ "H" series flange+high helix body & carbide insert (Φ12.0~50.0mm, 3xD, 5xD, 7xD, 10xD) 크루즈 "H" 시리즈 플랜지 드릴 바디	18~23	▲
<b>IDPH, IDFH, IDH, IDSH</b>	IDPH, IDFH, IDH, IDSH Carbide Drills Insert (Φ12.0~50.4mm) IDPH, IDFH, IDH, IDSH형 초경 인서트	18~23	▲
<b>KRUZ-SLK</b>	KRUZ "K" series Stubby type & 3D drill body & insert, Metric / Inch (Φ12.0~50.0mm) 철구 가공용 "K"시리즈 바디	24~27	●
<b>KRUZ-FSLK 5D, 7D</b>	KRUZ-FSLK Flanged body (5xD, 7xD), IDFK & IDPK insert (Φ12.0~50.0mm) 철구 가공용 "K"시리즈 FSLK 롱형 드릴 바디	28~29 30~31	●
<b>IDPK, IDFK</b>	IDPK, IDFK Carbide Drills Insert (Φ12.0~50.4mm) 초경 인서트	25~31	▲
<b>DMH</b>	Drilling & Milling tool "DMH" 드릴밀 홀더	32	▲
<b>DM</b>	Drilling & Milling tool "DM" 초경 드릴밀	32	▲
<b>MT, MTC</b>	MT shank side lock holder MT 샙크 사이드락 홀더	32	●
<b>STH</b>	Scribing tool "STH" 스크라이빙 툴 홀더	33	▲
<b>SD</b>	Scribing tool "SD" 초경 스크라이빙 드릴	33	▲

Model	Description & Available Standard Sizes	Page	Stock
<b>ISO45</b>	ISO 45 Extension holder for Structural 철구용 ISO45 톨연장 홀더	34	▲
<b>HSK</b>	HSK Extension holder for Structural 철구용 HSK 톨연장 홀더	34	○
<b>EXT</b>	Extension socket 철구용 톨연장 소켓	34	●
<b>RSL</b>	Reduction sleeve 철구용 생크조정 슬리브	35	▲
<b>YITM, ITM</b>	Indexable Thread Mill 인덱서블 스레드밀	38 39~43	○
<b>Special KRUZ</b>	Special KRUZ Step Drill body (drilling, chamfering, counter-boring in one tool body) 스페셜 크루즈 스텝드릴 바디(주문제작)	44	○
<b>KRUZ/DB</b>	"One Pass" Indexable Drilling & Deburring Bodies (Φ8.0~50.0mm) "원패스" 전후면취 겸용 드릴	45	○
<b>DBI</b>	Carbide Deburring Inserts, TiN, TiAlN coated (chamfer angle 45°, 60°) 초경 디버링 인서트	45	○
<b>YTRI</b>	YTRI Indexable Reamer body (Φ15.0~40.0mm) 인덱서블 리머 바디	46	▲
<b>IR, IBR</b>	IR, IBR Indexable Reamer & Broach Insert (Φ15.0~40.0mm) IR, IBR 인덱서블 리머 및 브로치 인서트	46	▲
<b>modified KRUZ</b>	KRUZ Combination Chamfer Tool KRUZ 개조형 면취 바디	46	○
<b>YCHR</b>	KRUZ Combination Chamfer Tool "YCHR" KRUZ용 면취툴	46	○
<b>YTD</b>	Carbide Brazed Tipped Drills, Metric / Inch (Φ13.5~41.5mm) 초경용접 팁 드릴	47~49	●
<b>YTDL</b>	Carbide Brazed Tipped Drills, Long series, Metric / Inch (Φ13.5~41.5mm) 초경용접 팁 드릴 롱시리즈	50~52	▲



Model	Description & Available Standard Sizes	Page	Stock
<b>YSR(L)</b> 	Solid carbide "Speedy" Reamer / Solid carbide Broach Reamer (Φ3.0~20mm) 초경 스피드 리머 / 초경 스피드 브로치리머	54	▲
<b>YSBR</b> 			
<b>YSD</b> 	Solid Carbide Drills, <b>Metric / Inch</b> (Φ3.0~20mm) 초경 솔리드 드릴	58~60	●
<b>YSDF</b> 	Solid Carbide Drills, "F" & "P" point Drills (Φ3.0~20mm) 초경 솔리드 "F" & "P" 포인트 드릴	56~57	○
<b>YSDP</b> 			
<b>YSDL</b> 	Solid Carbide Drills, Long series, <b>Metric / Inch</b> (Φ3.0~20mm) 초경 솔리드 드릴	61~63	●
<b>YSDLF</b> 	Solid Carbide Drills, Long series, "F" & "P" point Drills (Φ3.0~20mm) 초경 솔리드 "F" & "P" 포인트 드릴 롱시리즈	56~57	○
<b>YSDLP</b> 			
<b>YSDC</b> 	Solid Carbide Coolant Hole Drills, 5xD, HA shank, <b>Metric / Inch</b> (Φ5.0~20.0mm) 초경 쿨런트 드릴	64~66	●
<b>YSDCF</b> 			
<b>YSDCP</b> 	Solid Carbide Coolant Hole Drills, "F" & "P" point, 5xD, HA shank (Φ5.0~20.0mm) 초경 쿨런트 "F" & "P" 포인트 드릴	64~66	○
<b>YSDC,D5</b> 	Solid Carbide Coolant Drills, 5xD, HE shank (Φ5.0~20.0mm) 초경 쿨런트 드릴 (5xD)	67~68	●
<b>YSDCF,D5</b> 			
<b>YSDCP,D5</b> 	Solid Carbide Coolant Drills, "F" & "P" point, 5xD, HE shank (Φ5.0~20.0mm) 초경 쿨런트 "F" & "P" 포인트 드릴 (5xD)	67~68	○
<b>YSDC,D8</b> 	Solid Carbide Coolant Drills, 8xD, HE shank (Φ5.0~20.0mm) 초경 쿨런트 롱 드릴 (8xD)	69~70	○
<b>YSDCF,D8</b> 			
<b>YSDCP,D8</b> 	Solid Carbide Coolant Drills, "F" & "P" point, 8xD, HE shank (Φ5.0~20.0mm) 초경 쿨런트 "F" & "P" 포인트 롱드릴 (8xD)	69~70	○
<b>YCD</b> 	Solid Carbide Chamfer Drills, <b>Metric / Inch</b> (Φ5.1~20mm / Φ0.201~0.8125" ) 초경 챔퍼 드릴	71~73	● ○

Model	Description & Available Standard Sizes	Page	Stock
<b>YCH</b> 	Chamfer Holders for YCD, <b>Metric / Inch</b> (Φ6.0~20.0mm / Φ0.250~0.750") 챔퍼드릴용 홀더	74~75	● ○
<b>YTEI</b> 	Indexable "Eco-Cutter" system (Φ8.0~32.0mm) 인덱서블 "에코-커터" 바디	77	●
<b>IB,R</b> 	Carbide "Eco-Cutter" Insert Ball End Mills (Φ8.0~32.0mm) 초경 인서트 엔드밀	78~79	●
<b>IB,HR</b> 			
<b>IE,R</b> 	Carbide "Eco-Cutter" Insert End Mill & Center Drills (Φ8.0~32.0mm) 초경 인서트 엔드밀, 센터드릴	78~79	●
<b>ICD</b> 			
<b>YSET</b> 	Solid Carbide End Mills, TiAlN (Φ2.0~25.0mm) 초경 솔리드 엔드밀	80	▲
<b>YSEL</b> 	Solid Carbide End Mills, Long series, TiAlN (Φ6.0~25.0mm) 초경 솔리드 롱 엔드밀	80	▲
<b>YSET/HH</b> 	Solid Carbide High Helix End Mills, TiAlN (Φ6.0~32.0mm) 초경 하이헬릭스 엔드밀	81	▲
<b>YSER</b> 	Solid Carbide Roughing End Mills, TiAlN (Φ6.0~25.0mm) 초경 솔리드 러핑 엔드밀	81	▲
<b>YSEB</b> 	Solid Carbide Ball End Mills, TiAlN (Φ2.0~32.0mm) 초경 솔리드 볼 엔드밀	82	▲
<b>YSEBL</b> 	Solid Carbide Ball End Mills, Long series, TiAlN (Φ6.0~32.0mm) 초경 솔리드 볼 롱 엔드밀	82	▲
<b>YSEBG</b> 	Solid Carbide Ball End Mills for Graphite, TiAlN (Φ2.0~16.0mm) 초경 그래파이트용 엔드밀	83	▲
<b>DATA</b>	Technical Information 기술자료	84~97	



# Ordering information and identification system

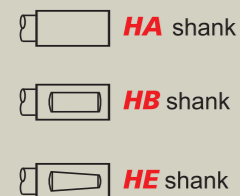
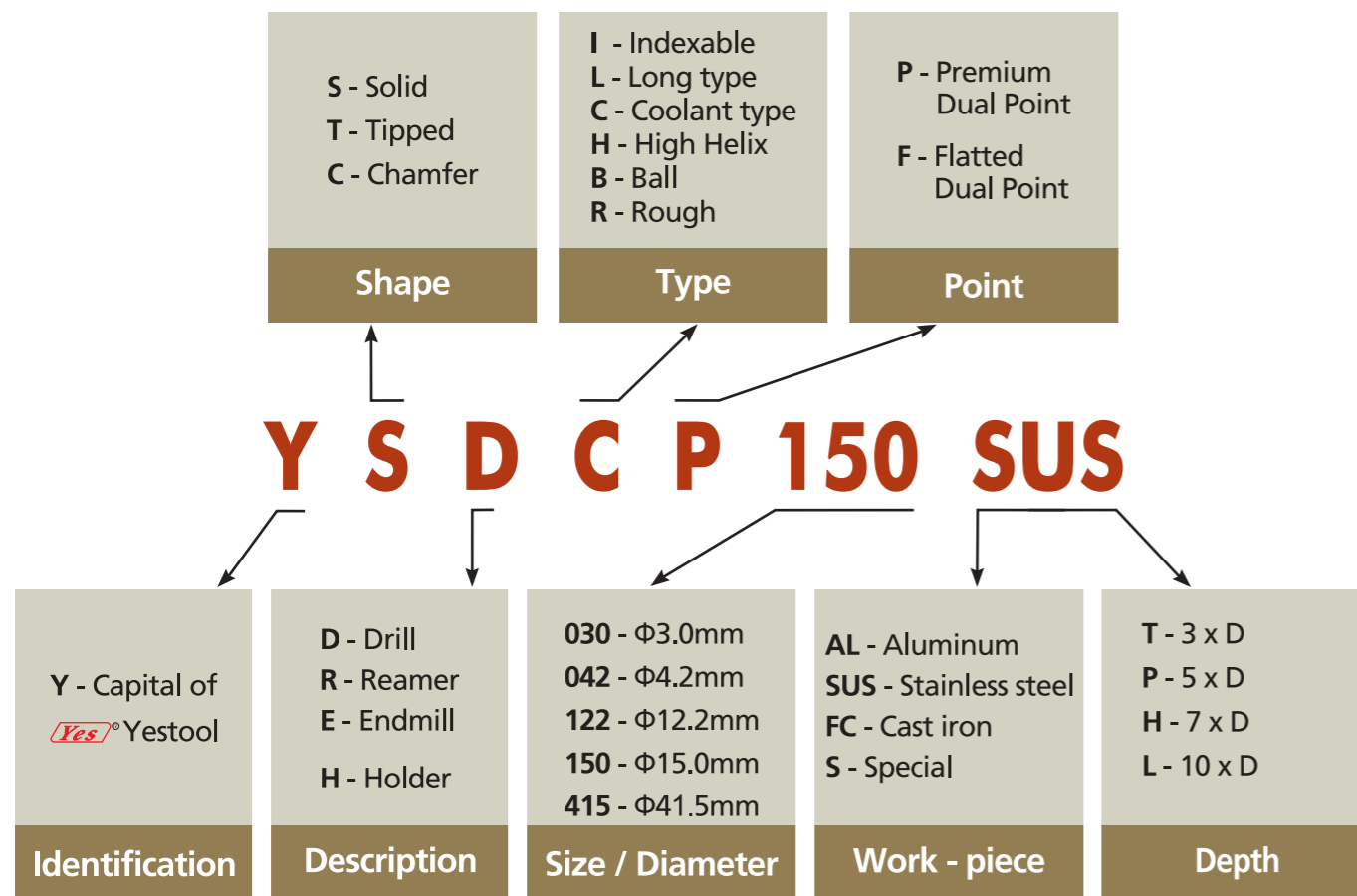

**Shank Option**

Yestool's product has different shank style each model. If requesting different shank style, please specify required shank on the left.



**KRUZ-FSL** Drill(Flange Type) Body & Carbide Insert  
**KRUZ "H"** series flange+high helix body & carbide insert  
**KRUZ "K"** series drill body & carbide insert for structural  
 Drilling & Milling tool holder & carbide drill  
 MT shank side lock holder  
 Scribing tool holder & scribing drill  
 ISO 45 & HSK Extension holder for Structural  
 Extension socket  
 Reduction sleeve  
 Thread Mill  
 KRUZ Combination Step Drill Body  
 "One Pass" Indexable Drilling & Deburring Body & Insert  
 Indexable Reamer Body & Carbide Insert Reamer  
 KRUZ combination chamfer ring  
 Carbide Brazed Tipped Drills  
 Carbide Brazed Tipped Drills, Long series  
 F1 deep hole drill (20xD ~ 50xD)

## Indexable, Coolant Drill Series





**Caution!!!** "H" series insert should use only with "H" series body to avoid drilling failure.

**KRUZ-FSL**

- ▶ Locking with dual screws(set & cap screw)
- ▶ Flanged body construction to reduce vibration
- ▶ Reinforced clamping power with bigger screws

**KRUZ-FH**

▶ "H" series body & insert available upon request only

- ▶ Higher helix flute to reduce machine load
- ▶ Locking with dual screws(set & cap screw)
- ▶ Flanged body construction to reduce vibration

<p><b>IDP</b></p> <ul style="list-style-type: none"> <li>▶ Deep hole &amp; general purpose</li> <li>▶ Patented dual point 130° + 150°</li> <li>▶ Coated with newest &lt;Y+&gt; coated</li> <li>▶ Designed for deep hole and tough job</li> </ul> <p><b>IDF</b></p> <ul style="list-style-type: none"> <li>▶ Thin plate &amp; shallow depth</li> <li>▶ Optimum geometry for structural beams</li> <li>▶ Dual point 140° + 170° side edge</li> <li>▶ Alternative solution for interrupted hole</li> </ul> <p><b>ID</b></p> <ul style="list-style-type: none"> <li>▶ General purpose</li> <li>▶ Conventional 140° single point</li> </ul>	<p><b>IDPH</b></p> <ul style="list-style-type: none"> <li>▶ Higher helix flute to fit in "H" series body</li> <li>▶ Deep hole &amp; general purpose</li> <li>▶ Patented dual point 130° + 150°</li> <li>▶ Designed for deep hole and tough job</li> </ul> <p><b>IDFH</b></p> <ul style="list-style-type: none"> <li>▶ Higher helix flute to fit in "H" series body</li> <li>▶ Thin plate &amp; shallow depth</li> <li>▶ Optimum geometry for structural beams</li> <li>▶ Dual point 140° + 170° side edge</li> <li>▶ Alternative solution for interrupted hole</li> </ul> <p><b>IDH</b></p> <ul style="list-style-type: none"> <li>▶ Higher helix flute to fit in "H" series body</li> <li>▶ General purpose</li> <li>▶ Conventional 140° single point</li> </ul> <p><b>IDSH</b></p> <ul style="list-style-type: none"> <li>▶ Higher helix flute to fit in "H" series body</li> <li>▶ Stainless, titanium or exotic material purpose</li> <li>▶ Conical 140° single point with oil groove face</li> </ul>
--	---

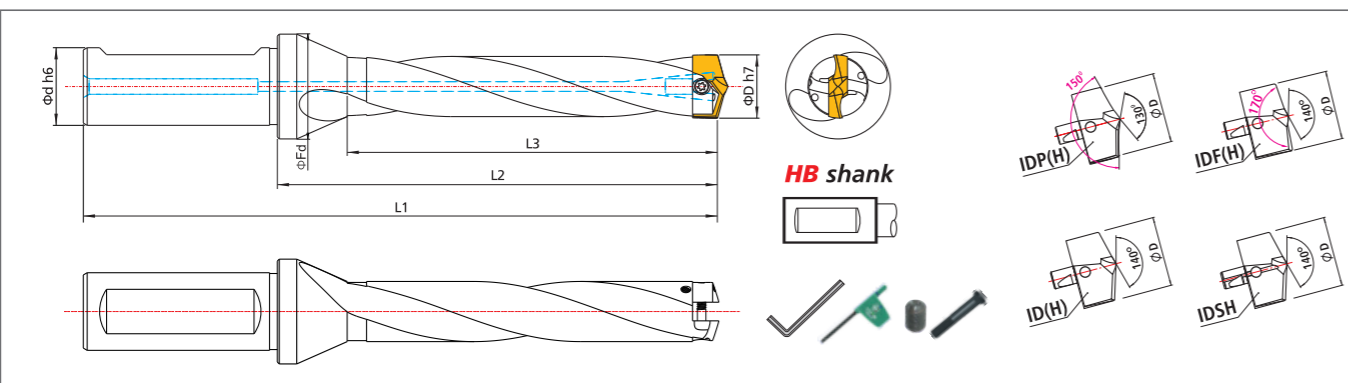

**KRUZ Body**

- ▶ Rugged heat-treated tool steel, polished flute to smooth chip removal
- ▶ Internal coolant channel through body
- ▶ Cylindrical with flatted HB Shank as standard( except small size 8 to 11.5mm cylindrical HA shank)
- ▶ Cutting length 3xDia, 5xDia, 7xDia, 10xDia Wide size selection 8 to 50mm as standard
- ▶ ID insert's quick change without picking up body in the machine
- ▶ Included necessary wrench and one steel bar to remove insert just for safety

KRUZ drill delivers outstanding performance at high speed. Chip feature after drilling. 12 spindles machining feature used KRUZ body & IDPK inserts

**Carbide insert drill**

- ▶ Ultra-micro grain carbide material to cover various material from soft to harder
  - ▶ Completely ground cutting edge in CNC program
  - ▶ Own designed point geometry to increase performance
  - ▶ Wide variety of size selection  $\phi 8.0$  to 50.4mm by 0.1mm inclusive from stock
- Standard and optional geometry for different material**
- ID & IDF coated with <TiAlN>, IDP coated with <Y+> as standard
  - AL : for Aluminum, made-to-order, uncoated but polished
  - SUS : for Stainless steel or Titanium, made-to-order
  - FC : for Cast iron, made-to-order
- Special made-to-order**
- precise micro-size by 0.01mm, different point angle, corner chamfer, corner radius step shape, flat bottom 180 like end-mill or different coating available upon request only

**Carbide material substrate**

All of Yestool's carbide cutting tool is made of ultra-micro grain carbide material with 13% cobalt contents. This would be greatly affected on higher performance and strong durability for various materials from soft to harder work pieces, even for difficult exotic materials.

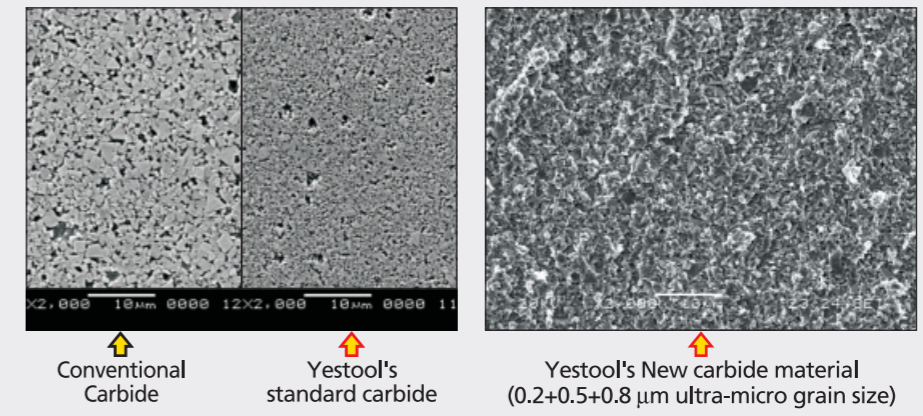

**Nomenclature of Carbide Insert**

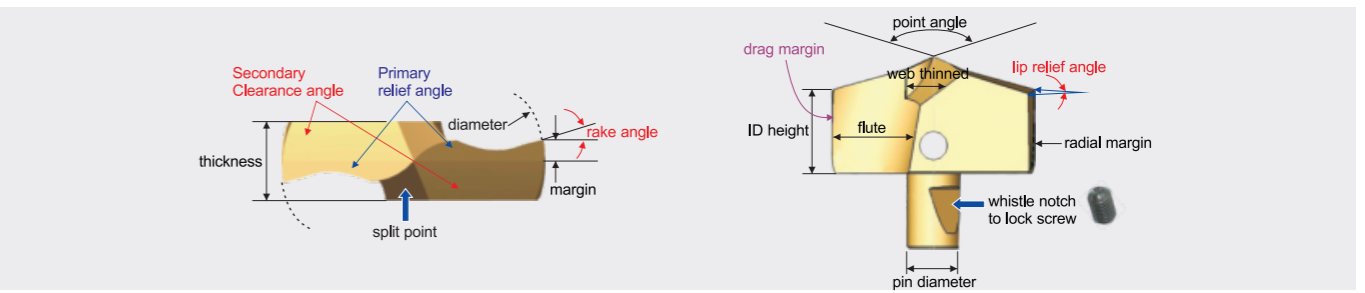

**Y+ coated insert**

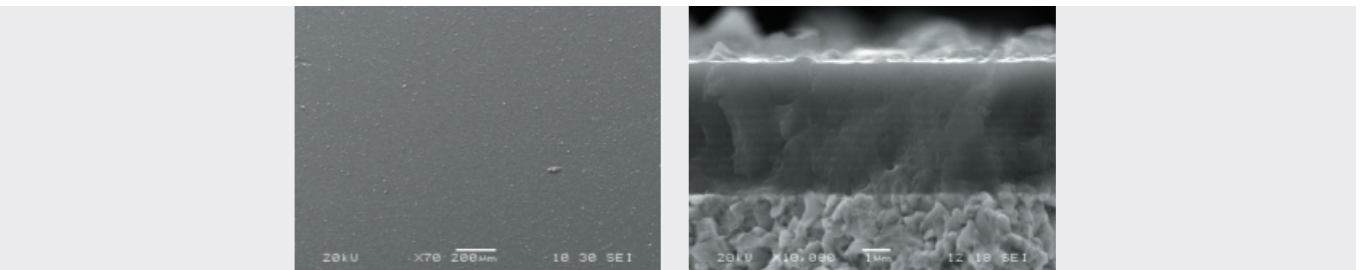

Coated surface. Coated layers



# KRUZ-FSL, YTDI-FSL Flange body & Carbide insert



KRUZ-FSL

IDP

IDF

ID

## Insert selection

Deep hole & general purpose

Thin plate & shallow depth

General purpose



KRUZ-FSL body

YTDI-FSL body

- ▶ Rugged flange type body to decrease vibration or chattering
- ▶ Interchangeable <IDP>, <IDF>, <ID> carbide drill inserts
- ▶ Drill body consists of premium tool steel with heat treatment
- ▶ Increased tool life by less vibration
- ▶ Internal coolant fed design

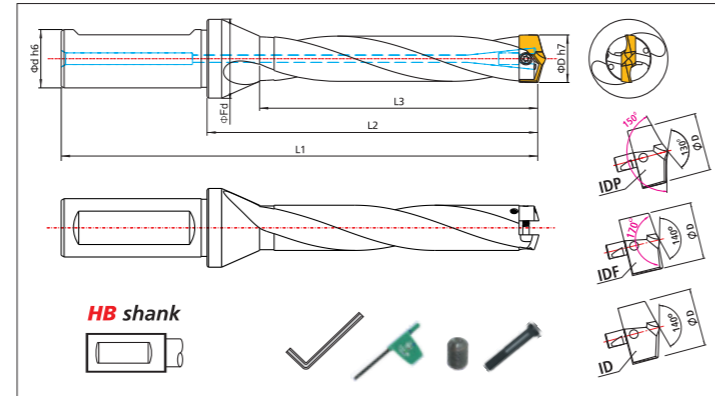

Please make required cutting depth in the □ like T, P, H, L

Hole size range	Body Code No.	Shank $\phi$ d / (L)	Cutting depth (Length x $\phi$ D)	L1	L2	L3	Flanged dia. ( $\phi$ Fd)	Insert Code No. to fit in body	Cap Screw	Torx driver	Set Screw	L-wrench	
$\phi$ 8.0 ~ $\phi$ 8.4	YTDI 080 □ FSL	10.0 (HA) (45)	T(3xD)	87	42	32	18	IDP 080, IDP 081, IDP 082, IDP 083, IDP 084 IDF 080, IDF 081, IDF 082, IDF 083, IDF 084 ID 080, ID 081, ID 082, ID 083, ID 084	CS 080 -085 SL				
	KRUZ 080 □ FSL		P(5xD)	103	58	48							
			H(7xD)	119	74	64							
			L(10xD)	143	98	88							
$\phi$ 8.5 ~ $\phi$ 8.9	YTDI 085 □ FSL	10.0 (HA) (45)	T(3xD)	89	44	34	18	IDP 085, IDP 086, IDP 087, IDP 088, IDP 089 IDF 085, IDF 086, IDF 087, IDF 088, IDF 089 ID 085, ID 086, ID 087, ID 088, ID 089	CS 080 -085 SL				
	KRUZ 085 □ FSL		P(5xD)	106	61	51							
			H(7xD)	123	78	68							
			L(10xD)	149	104	94							
$\phi$ 9.0 ~ $\phi$ 9.4	YTDI 090 □ FSL	10.0 (HA) (45)	T(3xD)	92	47	36	18	IDP 090, IDP 091, IDP 092, IDP 093, IDP 094 IDF 090, IDF 091, IDF 092, IDF 093, IDF 094 ID 090, ID 091, ID 092, ID 093, ID 094	CS 090 -095 SL				
	KRUZ 090 □ FSL		P(5xD)	110	65	54							
			H(7xD)	128	83	72							
			L(10xD)	155	110	99							
$\phi$ 9.5 ~ $\phi$ 9.9	YTDI 095 □ FSL	10.0 (HA) (45)	T(3xD)	97	49	38	18	IDP 095, IDP 096, IDP 097, IDP 098, IDP 099 IDF 095, IDF 096, IDF 097, IDF 098, IDF 099 ID 095, ID 096, ID 097, ID 098, ID 099	CS 090 -095 SL				
	KRUZ 095 □ FSL		P(5xD)	116	68	57							
			H(7xD)	135	87	76							
			L(10xD)	164	116	105							
$\phi$ 10.0 ~ $\phi$ 10.4	YTDI 100 □ FSL	12.0 (HA) (48)	T(3xD)	99	51	40	21	IDP 100, IDP 101, IDP 102, IDP 103, IDP 104 IDF 100, IDF 101, IDF 102, IDF 103, IDF 104 ID 100, ID 101, ID 102, ID 103, ID 104	CS 100 -115 SL	T6 Torque 0.6Nm (Max)	None	None	
	KRUZ 100 □ FSL		P(5xD)	119	71	60							
			H(7xD)	139	91	80							
			L(10xD)	169	121	110							
$\phi$ 10.5 ~ $\phi$ 10.9	YTDI 105 □ FSL	12.0 (HA) (48)	T(3xD)	102	54	42	21	IDP 105, IDP 106, IDP 107, IDP 108, IDP 109 IDF 105, IDF 106, IDF 107, IDF 108, IDF 109 ID 105, ID 106, ID 107, ID 108, ID 109	CS 100 -115 SL	T6 Torque 0.6Nm (Max)	None	None	
	KRUZ 105 □ FSL		P(5xD)	123	75	63							
			H(7xD)	144	96	84							
			L(10xD)	176	128	116							
$\phi$ 11.0 ~ $\phi$ 11.4	YTDI 110 □ FSL	12.0 (HA) (48)	T(3xD)	104	56	44	21	IDP 110, IDP 111, IDP 112, IDP 113, IDP 114 IDF 110, IDF 111, IDF 112, IDF 113, IDF 114 ID 110, ID 111, ID 112, ID 113, ID 114	CS 100 -115 SL	T6 Torque 0.6Nm (Max)	None	None	
	KRUZ 110 □ FSL		P(5xD)	126	78	66							
			H(7xD)	148	100	88							
			L(10xD)	181	133	121							
$\phi$ 11.5 ~ $\phi$ 11.9	YTDI 115 □ FSL	12.0 (HA) (48)	T(3xD)	107	59	46	21	IDP 115, IDP 116, IDP 117, IDP 118, IDP 119 IDF 115, IDF 116, IDF 117, IDF 118, IDF 119 ID 115, ID 116, ID 117, ID 118, ID 119	CS 100 -115 SL	T6 Torque 0.6Nm (Max)	None	None	
	KRUZ 115 □ FSL		P(5xD)	130	82	69							
			H(7xD)	153	105	92							
			L(10xD)	188	140	127							
$\phi$ 12.0 ~ $\phi$ 12.4	YTDI 120 □ FSL	16.0 (48)	T(3xD)	109	61	48	21	IDP 120, IDP 121, IDP 122, IDP 123, IDP 124 IDF 120, IDF 121, IDF 122, IDF 123, IDF 124 ID 120, ID 121, ID 122, ID 123, ID 124	CS 120 -135 SL	T6 Torque 0.6Nm (Max)			1.3mm
	KRUZ 120 □ FSL		P(5xD)	133	85	72							
			H(7xD)	157	109	96							
			L(10xD)	193	145	132							

Hole size range	Body Code No.	Shank $\phi$ d / (L)	Cutting depth (Length x $\phi$ D)	L1	L2	L3	Flanged dia. ( $\phi$ Fd)	Insert Code No. to fit in body	Cap Screw	Torx driver	Set Screw	L-wrench	
$\phi$ 12.5 ~ $\phi$ 12.9	YTDI 125 □ FSL	16.0 (48)	T(3xD)	111	63	50	21	IDP 125, IDP 126, IDP 127, IDP 128, IDP 129 IDF 125, IDF 126, IDF 127, IDF 128, IDF 129 ID 125, ID 126, ID 127, ID 128, ID 129	CS 120 -135 SL	T6 Torque 0.6Nm (Max)			
	KRUZ 125 □ FSL		P(5xD)	136	88	75							
			H(7xD)	161	113	100							
			L(10xD)	199	151	138							
$\phi$ 13.0 ~ $\phi$ 13.4	YTDI 130 □ FSL	16.0 (48)	T(3xD)	114	66	52	21	IDP 130, IDP 131, IDP 132, IDP 133, IDP 134 IDF 130, IDF 131, IDF 132, IDF 133, IDF 134 ID 130, ID 131, ID 132, ID 133, ID 134	CS 120 -135 SL	T6 Torque 0.6Nm (Max)			
	KRUZ 130 □ FSL		P(5xD)	140	92	78							
			H(7xD)	166	118	104							
			L(10xD)	205	157	143							
$\phi$ 13.5 ~ $\phi$ 13.9	YTDI 135 □ FSL	16.0 (48)	T(3xD)	116	68	54	21	IDP 135, IDP 136, IDP 137, IDP 138, IDP 139 IDF 135, IDF 136, IDF 137, IDF 138, IDF 139 ID 135, ID 136, ID 137, ID 138, ID 139	CS 120 -135 SL	T6 Torque 0.6Nm (Max)			
	KRUZ 135 □ FSL		P(5xD)	143	95	81							
			H(7xD)	170	122	108							
			L(10xD)	211	163	149							
$\phi$ 14.0 ~ $\phi$ 14.4	YTDI 140 □ FSL	16.0 (48)	T(3xD)	119	71	56	21	IDP 140, IDP 141, IDP 142, IDP 143, IDP 144 IDF 140, IDF 141, IDF 142, IDF 143, IDF 144 ID 140, ID 141, ID 142, ID 143, ID 144	CS 140 -155 SL				
	KRUZ 140 □ FSL		P(5xD)	147	99	84							
			H(7xD)	175	127	112							
			L(10xD)	217	169	154							
$\phi$ 14.5 ~ $\phi$ 14.9	YTDI 145 □ FSL	16.0 (48)	T(3xD)	123	73	58	21	IDP 145, IDP 146, IDP 147, IDP 148, IDP 149 IDF 145, IDF 146, IDF 147, IDF 148, IDF 149 ID 145, ID 146, ID 147, ID 148, ID 149	CS 140 -155 SL				
	KRUZ 145 □ FSL		P(5xD)	152	102	87							
			H(7xD)	181	131	116							
			L(10xD)	225	175	160							
$\phi$ 15.0 ~ $\phi$ 15.4	YTDI 150 □ FSL	16.0 (48)	T(3xD)	127	77	60	21	IDP 150, IDP 151, IDP 152, IDP 153, IDP 154 IDF 150, IDF 151, IDF 152, IDF 153, IDF 154 ID 150, ID 151, ID 152, ID 153, ID 154	CS 140 -155 SL				
	KRUZ 150 □ FSL		P(5xD)	157	107	90							
			H(7xD)	187	137	120							
			L(10xD)	232	182	165							
$\phi$ 15.5 ~ $\phi$ 15.9	YTDI 155 □ FSL	16.0 (48)	T(3xD)	130	80	62	21	IDP 155, IDP 156, IDP 157, IDP 158, IDP 159 IDF 155, IDF 156, IDF 157, IDF 158, IDF 159 ID 155, ID 156, ID 157, ID 158, ID 159	CS 140 -155 SL				
	KRUZ 155 □ FSL		P(5xD)	161	111	93							
			H(7xD)	192	142	124							
			L(10xD)	239	189	171							
$\phi$ 16.0 ~ $\phi$ 16.4	YTDI 160 □ FSL	16.0 (48)	T(3xD)	132	82	64	21	IDP 160, IDP 161, IDP 162, IDP 163, IDP 164 IDF 160, IDF 161, IDF 162, IDF 163, IDF 164 ID 160, ID 161, ID 162, ID 163, ID 164	CS 160 -175 SL	T7 Torque 0.9Nm (Max)	M2.5x4	1.3mm	
	KRUZ 160 □ FSL		P(5xD)	164	114	96							
			H(7xD)	196	146	128							
			L(10xD)	244	194	176							
$\phi$ 16.5 ~ $\phi$ 16.9	YTDI 165 □ FSL	16.0 (48)	T(3xD)	135	85	66	21	IDP 165, IDP 166, IDP 167, IDP 168, IDP 169 IDF 165, IDF 166, IDF 167, IDF 168, IDF 169 ID 165, ID 166, ID 167, ID 168, ID 169	CS 160 -175 SL	T7 Torque 0.9Nm (Max)	M2.5x4	1.3mm	
	KRUZ 165 □ FSL		P(5xD)	168	118	99							
			H(7xD)	201	151	132							
			L(10xD)	251	201	182							
$\phi$ 17.0 ~ $\phi$ 17.4	YTDI 170 □ FSL	20.0 (50)	T(3xD)	137	87	68	27	IDP 170, IDP 171, IDP 172, IDP 173, IDP 174 IDF 170, IDF 171, IDF 172, IDF 173, IDF 174 ID 170, ID 171, ID 172, ID 173, ID 174	CS 160 -175 SL				
	KRUZ 170 □ FSL		P(5xD)	171	121	102							
			H(7xD)	205	155	136							
			L(10xD)	256	206	187							
$\phi$ 17.5 ~ $\phi$ 17.9	YTDI 175 □ FSL	20.0 (50)	T(3xD)	139	89	70	27	IDP 175, IDP 176, IDP 177, IDP 178, IDP 179 IDF 175, IDF 176, IDF 177, IDF 178, IDF 179 ID 175, ID 176, ID 177, ID 178, ID 179	CS 160 -175 SL				
	KRUZ 175 □ FSL		P(5xD)	174	124	105							
			H(7xD)	209	159	140							
			L(10xD)	262	212	193							
$\phi$ 18.0 ~ $\phi$ 18.4	YTDI 180 □ FSL	20.0 (50)	T(3xD)	142	92	72	27	IDP 180, IDP 181, IDP 182, IDP 183, IDP 184 IDF 180, IDF 181, IDF 182, IDF 183, IDF 184 ID 180, ID 181, ID 182, ID 183, ID 184	CS 180 -195 SL				
	KRUZ 180 □ FSL		P(5xD)	178	128	108							
			H(7xD)	214	164	144							
			L(10xD)	268	218	198							
$\phi$ 18.5 ~ $\phi$ 18.9	YTDI 185 □ FSL	20.0 (50)	T(3xD)	144	94	74	27	IDP 185, IDP 186, IDP 187, IDP 188, IDP 189 IDF 185, IDF 186, IDF 187, IDF 188, IDF 189 ID 185, ID 186, ID 187, ID 188, ID 189	CS 180 -195 SL				
	KRUZ 185 □ FSL		P(5xD)	181	131	111							
			H(7xD)	218	168	148							
			L(10xD)	274	224	204							
$\phi$ 19.0 ~ $\phi$ 19.4	YTDI 190 □ FSL	20.0 (50)	T(3xD)	147	97	76	27	IDP 190, IDP 191, IDP 192, IDP 193, IDP 194 IDF 190, IDF 191, IDF 192, IDF 193, IDF 194 ID 190, ID 191, ID 192, ID 193, ID 194	CS 180 -195 SL	T8 Torque 1.5Nm (Max)			
	KRUZ 190 □ FSL		P(5xD)	185	135	114							
			H(7xD)	223	173	152							
			L(10xD)	280	230	209							
$\phi$ 19.5 ~ $\phi$ 19.9	YTDI 195 □ FSL	20.0 (50)	T(3xD)	149	99	78	27	IDP 195, IDP 196, IDP 197, IDP 198, IDP 199 IDF 195, IDF 196, IDF 197, IDF 198, IDF 199 ID 195, ID 196, ID 197, ID 198, ID 199	CS 180 -195 SL	T8 Torque 1.5Nm (Max)			
	KRUZ 195 □ FSL		P(5xD)	188	138	117							
			H(7xD)	227	177	156							
			L(10xD)	286	236	215							
$\phi$ 20.0 ~ $\phi$ 20.4	YTDI 200 □ FSL	25.0 (56)	T(3xD)	157	101	80	32	IDP 200, IDP 201, IDP 202, IDP 203, IDP 204 IDF 200, IDF 201, IDF 202, IDF 203, IDF 204 ID 200, ID 201, ID 202, ID 203, ID 204	CS 200 -215 SL			M3x6	1.5mm
	KRUZ 200 □ FSL		P(5xD)	197	141	120							
			H(7xD)	237	181	160							
			L(10xD)	297	241	220							

Continued ▶▶

Continued ▶▶

Indexable, Coolant Drill Series

Indexable, Coolant Drill Series



# KRUZ-FSL, YTDI-FSL Flange body & Carbide insert

Indexable, Coolant Drill Series

Hole size range	Body Code No.	Shank $\Phi d / (L)$	Cutting depth (Length x $\Phi D$ )	L1	L2	L3	Flanged dia. ( $\Phi Fd$ )	Insert Code No. to fit in body	Cap Screw	Torx driver	Set Screw	L-wrench																																																																
Φ20.5 ~Φ20.9	YTDI 205 □ FSL	25.0 (56)	T(3xD)	160	104	82	32	IDP 205, IDP 206, IDP 207, IDP 208, IDP 209 IDF 205, IDF 206, IDF 207, IDF 208, IDF 209 ID 205, ID 206, ID 207, ID 208, ID 209	CS 200 -215 SL	T8	Torque 1.5Nm (Max)	M3x6	1.5mm																																																															
	KRUZ 205 □ FSL		P(5xD)	201	145	123								H(7xD)	242	186	164	L(10xD)	304	248	226																																																							
Φ21.0 ~Φ21.4	YTDI 210 □ FSL		T(3xD)	162	106	84								32	IDP 210, IDP 211, IDP 212, IDP 213, IDP 214 IDF 210, IDF 211, IDF 212, IDF 213, IDF 214 ID 210, ID 211, ID 212, ID 213, ID 214	CS 200 -215 SL	T8	Torque 1.5Nm (Max)	M3x6	1.5mm																																																								
	KRUZ 210 □ FSL		P(5xD)	204	148	126															H(7xD)	246	190	168	L(10xD)	309	253	231																																																
Φ21.5 ~Φ21.9	YTDI 215 □ FSL		T(3xD)	165	109	86															32	IDP 215, IDP 216, IDP 217, IDP 218, IDP 219 IDF 215, IDF 216, IDF 217, IDF 218, IDF 219 ID 215, ID 216, ID 217, ID 218, ID 219	CS 200 -215 SL	T8	Torque 1.5Nm (Max)	M3x6	1.5mm																																																	
	KRUZ 215 □ FSL		P(5xD)	208	152	129																						H(7xD)	251	195	172	L(10xD)	316	260	237																																									
Φ22.0 ~Φ22.4	YTDI 220 □ FSL		T(3xD)	167	111	88																						32	IDP 220, IDP 221, IDP 222, IDP 223, IDP 224 IDF 220, IDF 221, IDF 222, IDF 223, IDF 224 ID 220, ID 221, ID 222, ID 223, ID 224	CS 220 -235 SL	T8	Torque 1.5Nm (Max)	M3x6	1.5mm																																										
	KRUZ 220 □ FSL		P(5xD)	211	155	132																													H(7xD)	255	199	176	L(10xD)	321	265	242																																		
Φ22.5 ~Φ22.9	YTDI 225 □ FSL		T(3xD)	169	113	90																													32	IDP 225, IDP 226, IDP 227, IDP 228, IDP 229 IDF 225, IDF 226, IDF 227, IDF 228, IDF 229 ID 225, ID 226, ID 227, ID 228, ID 229	CS 220 -235 SL	T8	Torque 1.5Nm (Max)	M3x6	1.5mm																																			
	KRUZ 225 □ FSL		P(5xD)	214	158	135																																				H(7xD)	259	203	180	L(10xD)	327	271	248																											
Φ23.0 ~Φ23.4	YTDI 230 □ FSL		T(3xD)	172	116	92																																				32	IDP 230, IDP 231, IDP 232, IDP 233, IDP 234 IDF 230, IDF 231, IDF 232, IDF 233, IDF 234 ID 230, ID 231, ID 232, ID 233, ID 234	CS 220 -235 SL	T8	Torque 1.5Nm (Max)	M3x6	1.5mm																												
	KRUZ 230 □ FSL		P(5xD)	218	162	138																																											H(7xD)	264	208	184	L(10xD)	333	277	253																				
Φ23.5 ~Φ23.9	YTDI 235 □ FSL		T(3xD)	174	118	94																																											32	IDP 235, IDP 236, IDP 237, IDP 238, IDP 239 IDF 235, IDF 236, IDF 237, IDF 238, IDF 239 ID 235, ID 236, ID 237, ID 238, ID 239	CS 220 -235 SL	T8	Torque 1.5Nm (Max)	M3x6	1.5mm																					
	KRUZ 235 □ FSL		P(5xD)	221	165	141																																																		H(7xD)	268	212	188	L(10xD)	339	283	259													
Φ24.0 ~Φ24.4	YTDI 240 □ FSL		T(3xD)	181	121	96																																																		32	IDP 240, IDP 241, IDP 242, IDP 243, IDP244 IDF 240, IDF 241, IDF 242, IDF 243, IDF244 ID 240, ID 241, ID 242, ID 243, ID 244	CS 240 -255 SL	T8	Torque 1.5Nm (Max)	M3x6	1.5mm														
	KRUZ 240 □ FSL		P(5xD)	229	169	144																																																									H(7xD)	277	217	192	L(10xD)	349	289	264						
Φ24.5 ~Φ24.9	YTDI 245 □ FSL		T(3xD)	183	123	98																																																									32	IDP 245, IDP 246, IDP 247, IDP 248, IDP 249 IDF 245, IDF 246, IDF 247, IDF 248, IDF 249 ID 245, ID 246, ID 247, ID 248, ID 249	CS 240 -255 SL	T8	Torque 1.5Nm (Max)	M3x6	1.5mm							
	KRUZ 245 □ FSL		P(5xD)	232	172	147																																																																H(7xD)	281	221	196	L(10xD)	355	295
Φ25.0 ~Φ25.4	YTDI 250 □ FSL		T(3xD)	185	125	100																																																																32	IDP 250, IDP 251, IDP 252, IDP 253, IDP 254 IDF 250, IDF 251, IDF 252, IDF 253, IDF 254 ID 250, ID 251, ID 252, ID 253, ID 254	CS 240 -255 SL	T8	Torque 1.5Nm (Max)	M3x6	1.5mm
	KRUZ 250 □ FSL		P(5xD)	235	175	150																																																																						
Φ25.5 ~Φ25.9	YTDI 255 □ FSL	T(3xD)	188	128	102	32	IDP 255, IDP 256, IDP 257, IDP 258, IDP 259 IDF 255, IDF 256, IDF 257, IDF 258, IDF 259 ID 255, ID 256, ID 257, ID 258, ID 259	CS 240 -255 SL	T8	Torque 1.5Nm (Max)	M3x6	1.5mm																																																																
	KRUZ 255 □ FSL	P(5xD)	239	179	153								H(7xD)																																																															
Φ26.0 ~Φ26.4	YTDI 260 □ FSL	T(3xD)	190	130	104								32.0 (60)	IDP 260, IDP 261, IDP 262, IDP 263, IDP 264 IDF 260, IDF 261, IDF 262, IDF 263, IDF 264 ID 260, ID 261, ID 262, ID 263, ID 264	CS 260 -275 SL	T15	Torque 3.5Nm (Max)	M4x8	2.0mm																																																									
	KRUZ 260 □ FSL	P(5xD)	242	182	156															H(7xD)																																																								
Φ26.5 ~Φ26.9	YTDI 265 □ FSL	T(3xD)	193	133	106															32.0 (60)	IDP 265, IDP 266, IDP 267, IDP 268, IDP 269 IDF 265, IDF 266, IDF 267, IDF 268, IDF 269 ID 265, ID 266, ID 267, ID 268, ID 269	CS 260 -275 SL	T15	Torque 3.5Nm (Max)	M4x8	2.0mm																																																		
	KRUZ 265 □ FSL	P(5xD)	246	186	159																						H(7xD)																																																	
Φ27.0 ~Φ27.4	YTDI 270 □ FSL	T(3xD)	195	135	108																						32.0 (60)	IDP 270, IDP 271, IDP 272, IDP 273, IDP 274 IDF 270, IDF 271, IDF 272, IDF 273, IDF 274 ID 270, ID 271, ID 272, ID 273, ID 274	CS 260 -275 SL	T15	Torque 3.5Nm (Max)	M4x8	2.0mm																																											
	KRUZ 270 □ FSL	P(5xD)	249	189	162																													H(7xD)																																										
Φ27.5 ~Φ27.9	YTDI 275 □ FSL	T(3xD)	197	137	110																													32.0 (60)	IDP 275, IDP 276, IDP 277, IDP 278, IDP 279 IDF 275, IDF 276, IDF 277, IDF 278, IDF 279 ID 275, ID 276, ID 277, ID 278, ID 279	CS 260 -275 SL	T15	Torque 3.5Nm (Max)	M4x8	2.0mm																																				
	KRUZ 275 □ FSL	P(5xD)	252	192	165																																				H(7xD)																																			
Φ28.0 ~Φ28.4	YTDI 280 □ FSL	T(3xD)	200	140	112																																				32.0 (60)	IDP 280, IDP 281, IDP 282, IDP 283, IDP 284 IDF 280, IDF 281, IDF 282, IDF 283, IDF 284 ID 280, ID 281, ID 282, ID 283, ID 284	CS 280 -295 SL	T15	Torque 3.5Nm (Max)	M4x8	2.0mm																													
	KRUZ 280 □ FSL	P(5xD)	256	196	168																																											H(7xD)																												

Hole size range	Body Code No.	Shank $\Phi d / (L)$	Cutting depth (Length x $\Phi D$ )	L1	L2	L3	Flanged dia. ( $\Phi Fd$ )	Insert Code No. to fit in body	Cap Screw	Torx driver	Set Screw	L-wrench																																																																
Φ28.5 ~Φ28.9	YTDI 285 □ FSL	32.0 (60)	T(3xD)	202	142	114	39	IDP 285, IDP 286, IDP 287, IDP 288, IDP 289 IDF 285, IDF 286, IDF 287, IDF 288, IDF 289 ID 285, ID 286, ID 287, ID 288, ID 289	CS 280 -295 SL	T15	Torque 3.5Nm (Max)	M4x8	2.0mm																																																															
	KRUZ 285 □ FSL		P(5xD)	259	199	171								H(7xD)	316	256	228	L(10xD)	402	342	314																																																							
Φ29.0 ~Φ29.4	YTDI 290 □ FSL		T(3xD)	205	145	116								39	IDP 290, IDP 291, IDP 292, IDP 293, IDP 294 IDF 290, IDF 291, IDF 292, IDF 293, IDF 294 ID 290, ID 291, ID 292, ID 293, ID 294	CS 280 -295 SL	T15	Torque 3.5Nm (Max)	M4x8	2.0mm																																																								
	KRUZ 290 □ FSL		P(5xD)	263	203	174															H(7xD)	321	261	232	L(10xD)	408	348	319																																																
Φ29.5 ~Φ29.9	YTDI 295 □ FSL		T(3xD)	207	147	118															39	IDP 295, IDP 296, IDP 297, IDP 298, IDP 299 IDF 295, IDF 296, IDF 297, IDF 298, IDF 299 ID 295, ID 296, ID 297, ID 298, ID 299	CS 280 -295 SL	T15	Torque 3.5Nm (Max)	M4x8	2.0mm																																																	
	KRUZ 295 □ FSL		P(5xD)	266	206	177																						H(7xD)	325	265	236	L(10xD)	414	354	325																																									
Φ30.0 ~Φ30.4	YTDI 300 □ FSL		T(3xD)	209	149	120																						39	IDP 300, IDP 301, IDP 302, IDP 303, IDP 304 IDF 300, IDF 301, IDF 302, IDF 303, IDF 304 ID 300, ID 301, ID 302, ID 303, ID 304	CS 300 -315 SL	T20	Torque 5.0Nm (Max)	M5x10	2.5mm																																										
	KRUZ 300 □ FSL		P(5xD)	269	209	180																													H(7xD)	329	269	240	L(10xD)	419	359	330																																		
Φ30.5 ~Φ30.9	YTDI 305 □ FSL		T(3xD)	212	152	122																													39	IDP 305, IDP 306, IDP 307, IDP 308, IDP 309 IDF 305, IDF 306, IDF 307, IDF 308, IDF 309 ID 305, ID 306, ID 307, ID 308, ID 309	CS 300 -315 SL	T20	Torque 5.0Nm (Max)	M5x10	2.5mm																																			
	KRUZ 305 □ FSL		P(5xD)	273	213	183																																				H(7xD)	334	274	244	L(10xD)	426	366	336																											
Φ31.0 ~Φ31.4	YTDI 310 □ FSL		T(3xD)	214	154	124																																				39	IDP 310, IDP 311, IDP 312, IDP 313, IDP 314 IDF 310, IDF 311, IDF 312, IDF 313, IDF 314 ID 310, ID 311, ID 312, ID 313, ID 314	CS 300 -315 SL	T20	Torque 5.0Nm (Max)	M5x10	2.5mm																												
	KRUZ 310 □ FSL		P(5xD)	276	216	186																																											H(7xD)	338	278	248	L(10xD)	431	371	341																				
Φ31.5 ~Φ31.9	YTDI 315 □ FSL		T(3xD)	217	157	126																																											39	IDP 315, IDP 316, IDP 317, IDP 318, IDP 319 IDF 315, IDF 316, IDF 317, IDF 318, IDF 319 ID 315, ID 316, ID 317, ID 318, ID 319	CS 300 -315 SL	T20	Torque 5.0Nm (Max)	M5x10	2.5mm																					
	KRUZ 315 □ FSL		P(5xD)	280	220	189																																																		H(7xD)	343	283	252	L(10xD)	438	378	347													
Φ32.0 ~Φ32.4	YTDI 320 □ FSL		T(3xD)	219	159	128																																																		39	IDP 320, IDP 321, IDP 322, IDP 323, IDP 324 IDF 320, IDF 321, IDF 322, IDF 323, IDF 324 ID 320, ID 321, ID 322, ID 323, ID 324	CS 320 -355 SL	T20	Torque 5.0Nm (Max)	M5x10	2.5mm														
	KRUZ 320 □ FSL		P(5xD)	283	223	192																																																									H(7xD)	347	287	256	L(10xD)	443	383	352						
Φ32.5 ~Φ32.9	YTDI 325 □ FSL		T(3xD)	221	161	130																																																									39	IDP 325, IDP 326, IDP 327, IDP 328, IDP 329 IDF 325, IDF 326, IDF 327, IDF 328, IDF 329 ID 325, ID 326, ID 327, ID 328, ID 329	CS 320 -355 SL	T20	Torque 5.0Nm (Max)	M5x10	2.5mm							
	KRUZ 325 □ FSL		P(5xD)	286	226	195																																																																H(7xD)	351	291	260	L(10xD)	449	389
Φ33.0 ~Φ33.4	YTDI 330 □ FSL		T(3xD)	224	164	132																																																																39	IDP 330, IDP 331, IDP 332, IDP 333, IDP 334 IDF 330, IDF 331, IDF 332, IDF 333, IDF 334 ID 330, ID 331, ID 332, ID 333, ID 334	CS 320 -355 SL	T20	Torque 5.0Nm (Max)	M5x10	2.5mm
	KRUZ 330 □ FSL		P(5xD)	290	230	198																																																																						
Φ33.5 ~Φ33.9	YTDI 335 □ FSL	T(3xD)	226	166	134	39	IDP 335, IDP 336, IDP 337, IDP 338, IDP 339 IDF 335, IDF 336, IDF 337, IDF 338, IDF 339 ID 335, ID 336, ID 337, ID 338, ID 339	CS 320 -355 SL	T20	Torque 5.0Nm (Max)	M5x10	2.5mm																																																																
	KRUZ 335 □ FSL	P(5xD)	293	233	201								H(7xD)																																																															
Φ34.0 ~Φ34.4	YTDI 340 □ FSL	T(3xD)	239	169	136								40.0 (70)	IDP 340, IDP 341, IDP 342, IDP 343, IDP 344 IDF 340, IDF 341, IDF 342, IDF 343, IDF 344 ID 340, ID 341, ID 342, ID 343, ID 344	CS 360 -395 SL	T15	Torque 3.5Nm (Max)	M4x8	2.0mm																																																									
	KRUZ 340 □ FSL	P(5xD)	307	237	204															H(7xD)																																																								
Φ34.5 ~Φ34.9	YTDI 345 □ FSL	T(3xD)	241	171	138															40.0 (70)	IDP 345, IDP 346, IDP 347, IDP 348, IDP 349 IDF 345, IDF 346, IDF 347,																																																							

# KRUZ-FSL, YTDI-FSL Flange body & Carbide insert

Indexable, Coolant Drill Series

Hole size range	Body Code No.	Shank $\Phi d / (L)$	Cutting depth (Length x $\Phi D$ )	L1	L2	L3	Flanged dia. ( $\Phi Fd$ )	Insert Code No. to fit in body	Cap Screw	Torx driver	Set Screw	L-wrench	
Φ36.5 ~Φ36.9	YTDI 365 □ FSL	40.0 (70)	T(3xD) 251 181 146	55	IDP 365, IDP 366, IDP 367, IDP 368, IDP 369 IDF 365, IDF 366, IDF 367, IDF 368, IDF 369 ID 365, ID 366, ID 367, ID 368, ID 369	CS 360 -395 SL	M5x10	2.5mm	T20 Torque 5.0Nm (Max)				
	KRUZ 365 □ FSL		P(5xD) 324 254 219										
Φ37.0 ~Φ37.4	YTDI 370 □ FSL		H(7xD) 397 327 292										IDP 370, IDP 371, IDP 372, IDP 373, IDP 374 IDF 370, IDF 371, IDF 372, IDF 373, IDF 374 ID 370, ID 371, ID 372, ID 373, ID 374
	KRUZ 370 □ FSL		L(10xD) 507 437 402										
Φ37.5 ~Φ37.9	YTDI 375 □ FSL		T(3xD) 253 183 148										IDP 375, IDP 376, IDP 377, IDP 378, IDP 379 IDF 375, IDF 376, IDF 377, IDF 378, IDF 379 ID 375, ID 376, ID 377, ID 378, ID 379
	KRUZ 375 □ FSL		P(5xD) 327 257 222										
Φ38.0 ~Φ38.4	YTDI 380 □ FSL		H(7xD) 401 331 296										IDP 380, IDP 381, IDP 382, IDP 383, IDP 384 IDF 380, IDF 381, IDF 382, IDF 383, IDF 384 ID 380, ID 381, ID 382, ID 383, ID 384
	KRUZ 380 □ FSL		L(10xD) 512 442 407										
Φ38.5 ~Φ38.9	YTDI 385 □ FSL		T(3xD) 255 185 150										IDP 385, IDP 386, IDP 387, IDP 388, IDP 389 IDF 385, IDF 386, IDF 387, IDF 388, IDF 389 ID 385, ID 386, ID 387, ID 388, ID 389
	KRUZ 385 □ FSL		P(5xD) 330 260 225										
Φ39.0 ~Φ39.4	YTDI 390 □ FSL		H(7xD) 405 335 300										IDP 390, IDP 391, IDP 392, IDP 393, IDP 394 IDF 390, IDF 391, IDF 392, IDF 393, IDF 394 ID 390, ID 391, ID 392, ID 393, ID 394
	KRUZ 390 □ FSL		L(10xD) 518 448 413										
Φ39.5 ~Φ39.9	YTDI 395 □ FSL		T(3xD) 258 188 152										IDP 395, IDP 396, IDP 397, IDP 398, IDP 399 IDF 395, IDF 396, IDF 397, IDF 398, IDF 399 ID 395, ID 396, ID 397, ID 398, ID 399
	KRUZ 395 □ FSL		P(5xD) 334 274 237										
Φ40.0 ~Φ40.4	YTDI 400 □ FSL		H(7xD) 410 340 304										IDP 400, IDP 401, IDP 402, IDP 403, IDP 404 IDF 400, IDF 401, IDF 402, IDF 403, IDF 404 ID 400, ID 401, ID 402, ID 403, ID 404
	KRUZ 400 □ FSL		L(10xD) 524 454 418										
Φ40.5 ~Φ40.9	YTDI 405 □ FSL		T(3xD) 260 196 154										IDP 405, IDP 406, IDP 407, IDP 408, IDP 409 IDF 405, IDF 406, IDF 407, IDF 408, IDF 409 ID 405, ID 406, ID 407, ID 408, ID 409
	KRUZ 405 □ FSL		P(5xD) 337 267 231										
Φ41.0 ~Φ41.4	YTDI 410 □ FSL		H(7xD) 414 344 308										IDP 410, IDP 411, IDP 412, IDP 413, IDP 414 IDF 410, IDF 411, IDF 412, IDF 413, IDF 414 ID 410, ID 411, ID 412, ID 413, ID 414
	KRUZ 410 □ FSL		L(10xD) 530 460 424										
Φ41.5 ~Φ41.9	YTDI 415 □ FSL	T(3xD) 263 193 156	IDP 415, IDP 416, IDP 417, IDP 418, IDP 419 IDF 415, IDF 416, IDF 417, IDF 418, IDF 419 ID 415, ID 416, ID 417, ID 418, ID 419										
	KRUZ 415 □ FSL	P(5xD) 341 271 234											
Φ42.0 ~Φ42.4	YTDI 420 □ FSL	H(7xD) 419 349 312	IDP 420, IDP 421, IDP 422, IDP 423, IDP 424 IDF 420, IDF 421, IDF 422, IDF 423, IDF 424 ID 420, ID 421, ID 422, ID 423, ID 424										
	KRUZ 420 □ FSL	L(10xD) 536 466 429											
Φ42.5 ~Φ42.9	YTDI 425 □ FSL	T(3xD) 265 195 158	IDP 425, IDP 426, IDP 427, IDP 428, IDP 429 IDF 425, IDF 426, IDF 427, IDF 428, IDF 429 ID 425, ID 426, ID 427, ID 428, ID 429										
	KRUZ 425 □ FSL	P(5xD) 344 274 237											
Φ43.0 ~Φ43.4	YTDI 430 □ FSL	H(7xD) 423 353 316	IDP 430, IDP 431, IDP 432, IDP 433, IDP 434 IDF 430, IDF 431, IDF 432, IDF 433, IDF 434 ID 430, ID 431, ID 432, ID 433, ID 434										
	KRUZ 430 □ FSL	L(10xD) 542 472 435											
Φ43.5 ~Φ43.9	YTDI 435 □ FSL	T(3xD) 267 197 160	IDP 435, IDP 436, IDP 437, IDP 438, IDP 439 IDF 435, IDF 436, IDF 437, IDF 438, IDF 439 ID 435, ID 436, ID 437, ID 438, ID 439										
	KRUZ 435 □ FSL	P(5xD) 347 277 240											
Φ44.0 ~Φ44.4	YTDI 440 □ FSL	H(7xD) 427 357 320	IDP 440, IDP 441, IDP 442, IDP 443, IDP 444 IDF 440, IDF 441, IDF 442, IDF 443, IDF 444 ID 440, ID 441, ID 442, ID 443, ID 444										
	KRUZ 440 □ FSL	L(10xD) 547 477 440											

Hole size range	Body Code No.	Shank $\Phi d / (L)$	Cutting depth (Length x $\Phi D$ )	L1	L2	L3	Flanged dia. ( $\Phi Fd$ )	Insert Code No. to fit in body	Cap Screw	Torx driver	Set Screw	L-wrench	
Φ44.5 ~Φ44.9	YTDI 445 □ FSL	40.0 (70)	T(3xD) 289 219 178	55	IDP 445, IDP 446, IDP 447, IDP 448, IDP 449 IDF 445, IDF 446, IDF 447, IDF 448, IDF 449 ID 445, ID 446, ID 447, ID 448, ID 449	CS 400 -445 SL	M6x12	3.0mm	T20 Torque 5.0Nm (Max)				
	KRUZ 445 □ FSL		P(5xD) 378 308 267										
Φ45.0 ~Φ45.4	YTDI 450 □ FSL		H(7xD) 467 397 356										IDP 450, IDP 451, IDP 452, IDP 453, IDP 454 IDF 450, IDF 451, IDF 452, IDF 453, IDF 454 ID 450, ID 451, ID 452, ID 453, ID 454
	KRUZ 450 □ FSL		L(10xD) 601 531 490										
Φ45.5 ~Φ45.9	YTDI 455 □ FSL		T(3xD) 291 221 180										IDP 455, IDP 456, IDP 457, IDP 458, IDP 459 IDF 455, IDF 456, IDF 457, IDF 458, IDF 459 ID 455, ID 456, ID 457, ID 458, ID 459
	KRUZ 455 □ FSL		P(5xD) 381 311 270										
Φ46.0 ~Φ46.4	YTDI 460 □ FSL		H(7xD) 471 401 360										IDP 460, IDP 461, IDP 462, IDP 463, IDP 464 IDF 460, IDF 461, IDF 462, IDF 463, IDF 464 ID 460, ID 461, ID 462, ID 463, ID 464
	KRUZ 460 □ FSL		L(10xD) 606 536 495										
Φ46.5 ~Φ46.9	YTDI 465 □ FSL		T(3xD) 294 224 182										IDP 465, IDP 466, IDP 467, IDP 468, IDP 469 IDF 465, IDF 466, IDF 467, IDF 468, IDF 469 ID 465, ID 466, ID 467, ID 468, ID 469
	KRUZ 465 □ FSL		P(5xD) 385 315 273										
Φ47.0 ~Φ47.4	YTDI 470 □ FSL		H(7xD) 476 406 364										IDP 470, IDP 471, IDP 472, IDP 473, IDP 474 IDF 470, IDF 471, IDF 472, IDF 473, IDF 474 ID 470, ID 471, ID 472, ID 473, ID 474
	KRUZ 470 □ FSL		L(10xD) 613 543 501										
Φ47.5 ~Φ47.9	YTDI 475 □ FSL		T(3xD) 296 226 184										IDP 475, IDP 476, IDP 477, IDP 478, IDP 479 IDF 475, IDF 476, IDF 477, IDF 478, IDF 479 ID 475, ID 476, ID 477, ID 478, ID 479
	KRUZ 475 □ FSL		P(5xD) 388 318 276										
Φ48.0 ~Φ48.4	YTDI 480 □ FSL		H(7xD) 480 410 368										IDP 480, IDP 481, IDP 482, IDP 483, IDP 484 IDF 480, IDF 481, IDF 482, IDF 483, IDF 484 ID 480, ID 481, ID 482, ID 483, ID 484
	KRUZ 480 □ FSL		L(10xD) 618 548 506										
Φ48.5 ~Φ48.9	YTDI 485 □ FSL		T(3xD) 299 229 186										IDP 485, IDP 486, IDP 487, IDP 488, IDP 489 IDF 485, IDF 486, IDF 487, IDF 488, IDF 489 ID 485, ID 486, ID 487, ID 488, ID 489
	KRUZ 485 □ FSL		P(5xD) 392 322 279										
Φ49.0 ~Φ49.4	YTDI 490 □ FSL		H(7xD) 485 415 372										IDP 490, IDP 491, IDP 492, IDP 493, IDP 494 IDF 490, IDF 491, IDF 492, IDF 493, IDF 494 ID 490, ID 491, ID 492, ID 493, ID 494
	KRUZ 490 □ FSL		L(10xD) 625 555 512										
Φ49.5 ~Φ49.9	YTDI 495 □ FSL	T(3xD) 301 231 188	IDP 495, IDP 496, IDP 497, IDP 498, IDP 499 IDF 495, IDF 496, IDF 497, IDF 498, IDF 499 ID 495, ID 496, ID 497, ID 498, ID 499										
	KRUZ 495 □ FSL	P(5xD) 395 325 282											
Φ50.0 ~Φ50.4	YTDI 500 □ FSL	H(7xD) 489 419 376	IDP 500, IDP 501, IDP 502, IDP 503, IDP 504 IDF 500, IDF 501, IDF 502, IDF 503, IDF 504 ID 500, ID 501, ID 502, ID 503, ID 504										
	KRUZ 500 □ FSL	L(10xD) 630 560 517											

## KRUZ-FSL Drills, Cutting Speed Recommendation

Drill Dia.	Φ8~16mm		Φ16~25mm		Φ25~32mm		Φ32~40mm		Φ40~50mm	
	Speed (m/min)	Feed (mm/rev)	Speed (m/min)	Feed (mm/rev)	Speed (m/min)	Feed (mm/rev)	Speed (m/min)	Feed (mm/rev)	Speed (m/min)	Feed (mm/rev)
Grey cast iron (FC)	80~150	0.20~0.30	80~150	0.25~0.45	80~160	0.35~0.55	90~200	0.34~0.58	90~200	0.38~0.60
Nodular cast iron (FCD)	80~140	0.15~0.25	80~140	0.22~0.45	80~150	0.32~0.52	90~160	0.35~0.62	90~200	0.38~0.60
Carbon steel (S45C)	80~140	0.15~0.30	80~140	0.16~0.40	80~150	0.20~0.40	80~150	0.22~0.48	80~160	0.25~0.54
Alloy steel (SCM440)	70~140	0.15~0.30	70~140	0.15~0.40	70~140	0.18~0.40	80~140	0.25~0.47	80~140	0.27~0.52
Hardened steel (SKD11)	40~50	0.10~0.20	40~50	0.12~0.28	40~50	0.16~0.35	40~60	0.20~0.38	40~60	0.22~0.42
Stainless steel (SUS)	30~40	0.10~0.20	35~50	0.10~0.22	35~50	0.15~0.28	40~55	0.18~0.30	40~55	0.22~0.32
Aluminum 130HB (AL)	120~200	0.20~0.30	120~200	0.25~0.40	120~200	0.30~0.45	120~200	0.30~0.45	120~200	0.30~0.50

☞ This data is recommended for 3xDia. And should be reduced about 15~20% for 5xD, 7xD, 10xD drills.

☞ The data is normally suggested for oil-mist(MQL) coolant condition and also possible to run in other normal condition if machining environment like clamping etc. are secured in good.

Indexable, Coolant Drill Series



# **KRUZ "H" series flange + higher helix body & carbide insert**

**Caution >> "H" series insert should use only with "H" series body to avoid drilling failure.**



- ▶ Higher helix flute to reduce machine load and faster chip ejection
- ▶ Rugged flange type body to decrease vibration or chattering
- ▶ Interchangeable <IDPH>, <IDFH>, <IDH>, <IDSH> carbide "H" drill inserts
- ▶ Drill body consists of premium tool steel with heat treatment
- ▶ Increased tool life by less vibration
- ▶ Internal coolant fed design
- ▶ "H" series body and insert available upon request only

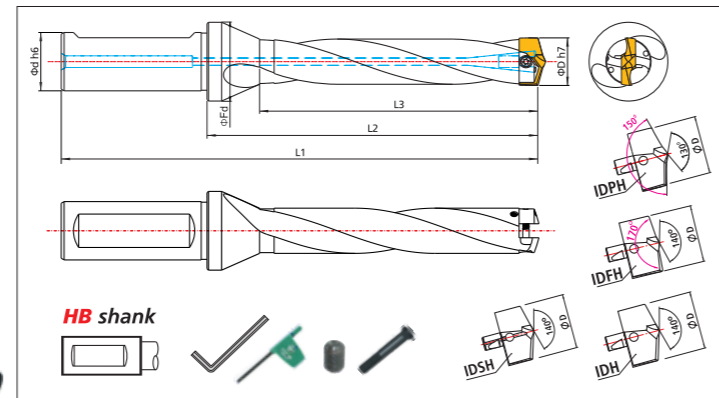

- Insert selection**
- IDPH** Deep hole & general purpose
  - IDFH** Thin plate & shallow depth
  - IDH** General purpose
  - IDSH** Stainless, titanium or exotic material purpose

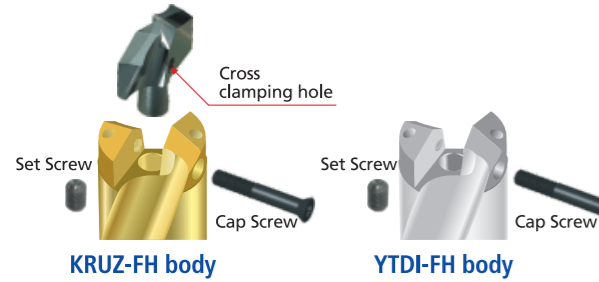

Please make required cutting depth in the □ like T, P, H, L

Hole size range	Body Code No.	Shank $\phi d / (L)$	Cutting depth (Length x $\phi D$ )	L1	L2	L3	Flanged dia. ( $\phi Fd$ )	Insert Code No. to fit in body	Cap Screw	Torx driver	Set Screw	L-wrench
Φ12.0 ~Φ12.4	YTDI 120 □ FH	16.0 (48)	T(3xD)	109	61	48	21	IDPH 120, IDPH 121, IDPH 122, IDPH 123, IDPH 124 IDFH 120, IDFH 121, IDFH 122, IDFH 123, IDFH 124 IDH 120, IDH 121, IDH 122, IDH 123, IDH 124 IDSH 120, IDSH 121, IDSH 122, IDSH 123, IDSH 124	CS120 -135 SL	T6 Torque 0.6Nm (Max)		
	KRUZ 120 □ FH		P(5xD)	133	85	72						
			H(7xD)	157	109	96						
			L(10xD)	193	145	132						
Φ12.5 ~Φ12.9	YTDI 125 □ FH	16.0 (48)	T(3xD)	111	63	50	21	IDPH 125, IDPH 126, IDPH 127, IDPH 128, IDPH 129 IDFH 125, IDFH 126, IDFH 127, IDFH 128, IDFH 129 IDH 125, IDH 126, IDH 127, IDH 128, IDH 129 IDSH 125, IDSH 126, IDSH 127, IDSH 128, IDSH 129	CS120 -135 SL	T6 Torque 0.6Nm (Max)		
	KRUZ 125 □ FH		P(5xD)	136	88	75						
			H(7xD)	161	113	100						
			L(10xD)	199	151	138						
Φ13.0 ~Φ13.4	YTDI 130 □ FH	16.0 (48)	T(3xD)	114	66	52	21	IDPH 130, IDPH 131, IDPH 132, IDPH 133, IDPH 134 IDFH 130, IDFH 131, IDFH 132, IDFH 133, IDFH 134 IDH 130, IDH 131, IDH 132, IDH 133, IDH 134 IDSH 130, IDSH 131, IDSH 132, IDSH 133, IDSH 134	CS120 -135 SL	T6 Torque 0.6Nm (Max)		
	KRUZ 130 □ FH		P(5xD)	140	92	78						
			H(7xD)	166	118	104						
			L(10xD)	205	157	143						
Φ13.5 ~Φ13.9	YTDI 135 □ FH	16.0 (48)	T(3xD)	116	68	54	21	IDPH 135, IDPH 136, IDPH 137, IDPH 138, IDPH 139 IDFH 135, IDFH 136, IDFH 137, IDFH 138, IDFH 139 IDH 135, IDH 136, IDH 137, IDH 138, IDH 139 IDSH 135, IDSH 136, IDSH 137, IDSH 138, IDSH 139	CS120 -135 SL	T6 Torque 0.6Nm (Max)		
	KRUZ 135 □ FH		P(5xD)	143	95	81						
			H(7xD)	170	122	108						
			L(10xD)	211	163	149						
Φ14.0 ~Φ14.4	YTDI 140 □ FH	16.0 (48)	T(3xD)	119	71	56	21	IDPH 140, IDPH 141, IDPH 142, IDPH 143, IDPH 144 IDFH 140, IDFH 141, IDFH 142, IDFH 143, IDFH 144 IDH 140, IDH 141, IDH 142, IDH 143, IDH 144 IDSH 140, IDSH 141, IDSH 142, IDSH 143, IDSH 144	CS120 -135 SL	T6 Torque 0.6Nm (Max)		
	KRUZ 140 □ FH		P(5xD)	147	99	84						
			H(7xD)	175	127	112						
			L(10xD)	217	169	154						
Φ14.5 ~Φ14.9	YTDI 145 □ FH	20.0 (50)	T(3xD)	123	73	58	27	IDPH 145, IDPH 146, IDPH 147, IDPH 148, IDPH 149 IDFH 145, IDFH 146, IDFH 147, IDFH 148, IDFH 149 IDH 145, IDH 146, IDH 147, IDH 148, IDH 149 IDSH 145, IDSH 146, IDSH 147, IDSH 148, IDSH 149	CS140 -155 SL	T7 Torque 0.9Nm (Max)		
	KRUZ 145 □ FH		P(5xD)	152	102	87						
			H(7xD)	181	131	116						
			L(10xD)	225	175	160						
Φ15.0 ~Φ15.4	YTDI 150 □ FH	20.0 (50)	T(3xD)	127	77	60	27	IDPH 150, IDPH 151, IDPH 152, IDPH 153, IDPH 154 IDFH 150, IDFH 151, IDFH 152, IDFH 153, IDFH 154 IDH 150, IDH 151, IDH 152, IDH 153, IDH 154 IDSH 150, IDSH 151, IDSH 152, IDSH 153, IDSH 154	CS140 -155 SL	T7 Torque 0.9Nm (Max)		
	KRUZ 150 □ FH		P(5xD)	157	107	90						
			H(7xD)	187	137	120						
			L(10xD)	232	182	165						

Hole size range	Body Code No.	Shank $\phi d / (L)$	Cutting depth (Length x $\phi D$ )	L1	L2	L3	Flanged dia. ( $\phi Fd$ )	Insert Code No. to fit in body	Cap Screw	Torx driver	Set Screw	L-wrench
Φ15.5 ~Φ15.9	YTDI 155 □ FH	20.0 (50)	T(3xD)	130	80	62	27	IDPH 155, IDPH 156, IDPH 157, IDPH 158, IDPH 159 IDFH 155, IDFH 156, IDFH 157, IDFH 158, IDFH 159 IDH 155, IDH 156, IDH 157, IDH 158, IDH 159 IDSH 155, IDSH 156, IDSH 157, IDSH 158, IDSH 159	CS 140 -155 SL			
	KRUZ 155 □ FH		P(5xD)	161	111	93						
			H(7xD)	192	142	124						
			L(10xD)	239	189	171						
Φ16.0 ~Φ16.4	YTDI 160 □ FH	20.0 (50)	T(3xD)	132	82	64	27	IDPH 160, IDPH 161, IDPH 162, IDPH 163, IDPH 164 IDFH 160, IDFH 161, IDFH 162, IDFH 163, IDFH 164 IDH 160, IDH 161, IDH 162, IDH 163, IDH 164 IDSH 160, IDSH 161, IDSH 162, IDSH 163, IDSH 164	CS 160 -175 SL	T7 Torque 0.9Nm (Max)		
	KRUZ 160 □ FH		P(5xD)	164	114	96						
			H(7xD)	196	146	128						
			L(10xD)	244	194	176						
Φ16.5 ~Φ16.9	YTDI 165 □ FH	20.0 (50)	T(3xD)	135	85	66	27	IDPH 165, IDPH 166, IDPH 167, IDPH 168, IDPH 169 IDFH 165, IDFH 166, IDFH 167, IDFH 168, IDFH 169 IDH 165, IDH 166, IDH 167, IDH 168, IDH 169 IDSH 165, IDSH 166, IDSH 167, IDSH 168, IDSH 169	CS 160 -175 SL	T7 Torque 0.9Nm (Max)		
	KRUZ 165 □ FH		P(5xD)	168	118	99						
			H(7xD)	201	151	132						
			L(10xD)	251	201	182						
Φ17.0 ~Φ17.4	YTDI 170 □ FH	20.0 (50)	T(3xD)	137	87	68	27	IDPH 170, IDPH 171, IDPH 172, IDPH 173, IDPH 174 IDFH 170, IDFH 171, IDFH 172, IDFH 173, IDFH 174 IDH 170, IDH 171, IDH 172, IDH 173, IDH 174 IDSH 170, IDSH 171, IDSH 172, IDSH 173, IDSH 174	CS 160 -175 SL	T7 Torque 0.9Nm (Max)		
	KRUZ 170 □ FH		P(5xD)	171	121	102						
			H(7xD)	205	155	136						
			L(10xD)	256	206	187						
Φ17.5 ~Φ17.9	YTDI 175 □ FH	20.0 (50)	T(3xD)	139	89	70	27	IDPH 175, IDPH 176, IDPH 177, IDPH 178, IDPH 179 IDFH 175, IDFH 176, IDFH 177, IDFH 178, IDFH 179 IDH 175, IDH 176, IDH 177, IDH 178, IDH 179 IDSH 175, IDSH 176, IDSH 177, IDSH 178, IDSH 179	CS 160 -175 SL	T7 Torque 0.9Nm (Max)		
	KRUZ 175 □ FH		P(5xD)	174	124	105						
			H(7xD)	209	159	140						
			L(10xD)	262	212	193						
Φ18.0 ~Φ18.4	YTDI 180 □ FH	20.0 (50)	T(3xD)	142	92	72	27	IDPH 180, IDPH 181, IDPH 182, IDPH 183, IDPH 184 IDFH 180, IDFH 181, IDFH 182, IDFH 183, IDFH 184 IDH 180, IDH 181, IDH 182, IDH 183, IDH 184 IDSH 180, IDSH 181, IDSH 182, IDSH 183, IDSH 184	CS 180 -195 SL	T8 Torque 1.5Nm (Max)		
	KRUZ 180 □ FH		P(5xD)	178	128	108						
			H(7xD)	214	164	144						
			L(10xD)	268	218	198						
Φ18.5 ~Φ18.9	YTDI 185 □ FH	20.0 (50)	T(3xD)	144	94	74	27	IDPH 185, IDPH 186, IDPH 187, IDPH 188, IDPH 189 IDFH 185, IDFH 186, IDFH 187, IDFH 188, IDFH 189 IDH 185, IDH 186, IDH 187, IDH 188, IDH 189 IDSH 185, IDSH 186, IDSH 187, IDSH 188, IDSH 189	CS 180 -195 SL	T8 Torque 1.5Nm (Max)		
	KRUZ 185 □ FH		P(5xD)	181	131	111						
			H(7xD)	218	168	148						
			L(10xD)	274	224	204						
Φ19.0 ~Φ19.4	YTDI 190 □ FH	20.0 (50)	T(3xD)	147	97	76	27	IDPH 190, IDPH 191, IDPH 192, IDPH 193, IDPH 194 IDFH 190, IDFH 191, IDFH 192, IDFH 193, IDFH 194 IDH 190, IDH 191, IDH 192, IDH 193, IDH 194 IDSH 190, IDSH 191, IDSH 192, IDSH 193, IDSH 194	CS 180 -195 SL	T8 Torque 1.5Nm (Max)		
	KRUZ 190 □ FH		P(5xD)	185	135	114						
			H(7xD)	223	173	152						
			L(10xD)	280	230	209						
Φ19.5 ~Φ19.9	YTDI 195 □ FH	20.0 (50)	T(3xD)	149	99	78	27	IDPH 195, IDPH 196, IDPH 197, IDPH 198, IDPH 199 IDFH 195, IDFH 196, IDFH 197, IDFH 198, IDFH 199 IDH 195, IDH 196, IDH 197, IDH 198, IDH 199 IDSH 195, IDSH 196, IDSH 197, IDSH 198, IDSH 199	CS 180 -195 SL	T8 Torque 1.5Nm (Max)		
	KRUZ 195 □ FH		P(5xD)	188	138	117						
			H(7xD)	227	177	156						
			L(10xD)	286	236	215						
Φ20.0 ~Φ20.4	YTDI 200 □ FH	25.0 (56)	T(3xD)	157	101	80	32	IDPH 200, IDPH 201, IDPH 202, IDPH 203, IDPH 204 IDFH 200, IDFH 201, IDFH 202, IDFH 203, IDFH 204 IDH 200, IDH 201, IDH 202, IDH 203, IDH 204 IDSH 200, IDSH 201, IDSH 202, IDSH 203, IDSH 204	CS 200 -215 SL	T8 Torque 1.5Nm (Max)		
	KRUZ 200 □ FH		P(5xD)	197	141	120						
			H(7xD)	237	181	160						
			L(10xD)	297	241	220						
Φ20.5 ~Φ20.9	YTDI 205 □ FH	25.0 (56)	T(3xD)	160	104	82	32	IDPH 205, IDPH 206, IDPH 207, IDPH 208, IDPH 209 IDFH 205, IDFH 206, IDFH 207, IDFH 208, IDFH 209 IDH 205, IDH 206, IDH 207, IDH 208, IDH 209 IDSH 205, IDSH 206, IDSH 207, IDSH 208, IDSH 209	CS 200 -215 SL	T8 Torque 1.5Nm (Max)		
	KRUZ 205 □ FH		P(5xD)	201	145	123						
			H(7xD)	242	186	164						
			L(10xD)	304	248	226						
Φ21.0 ~Φ21.4	YTDI 210 □ FH	25.0 (56)	T(3xD)	162	106	84	32	IDPH 210, IDPH 211, IDPH 212, IDPH 213, IDPH 214 IDFH 210, IDFH 211, IDFH 212, IDFH 213, IDFH 214 IDH 210, IDH 211, IDH 212, IDH 213, IDH 214 IDSH 210, IDSH 211, IDSH 212, IDSH 213, IDSH 214	CS 200 -215 SL	T8 Torque 1.5Nm (Max)		
	KRUZ 210 □ FH		P(5xD)	204	148	126						
			H(7xD)	246	190	168						
			L(10xD)	309	253	231						
Φ21.5 ~Φ21.9	YTDI 215 □ FH	25.0 (56)	T(3xD)	165	109	86	32	IDPH 215, IDPH 216, IDPH 217, IDPH 218, IDPH 219 IDFH 215, IDFH 216, IDFH 217, IDFH 218, IDFH 219 IDH 215, IDH 216, IDH 217, IDH 218, IDH 219 IDSH 215, IDSH 216, IDSH 217, IDSH 218, IDSH 219	CS 200 -215 SL	T8 Torque 1.5Nm (Max)		
	KRUZ 215 □ FH		P(5xD)	208	152	129						
			H(7xD)	251	195	172						
			L(10xD)	316	260	237						
Φ22.0 ~Φ22.4	YTDI 220 □ FH	25.0 (56)	T(3xD)	167	111	88	32	IDPH 220, IDPH 221, IDPH 222, IDPH 223, IDPH 224 IDFH 220, IDFH 221, IDFH 222, IDFH 223, IDFH 224 IDH 220, IDH 221, IDH 222, IDH 223, IDH 224 IDSH 220, IDSH 221, IDSH 222, IDSH 223, IDSH 224	CS 220 -235 SL	T8 Torque 1.5Nm (Max)		
	KRUZ 220 □ FH		P(5xD)	211	155	132						
			H(7xD)	255	199	176						
			L(10xD)	321	265	242						
Φ22.5 ~Φ22.9	YTDI 225 □ FH	25.0 (56)	T(3xD)	169	113	90	32	IDPH 225, IDPH 226, IDPH 227, IDPH 228, IDPH 229 IDFH 225, IDFH 226, IDFH 227, IDFH 228, IDFH 229 IDH 225, IDH 226, IDH 227, IDH 228, IDH 229 IDSH 225, IDSH 226, IDSH 227, IDSH 228, IDSH 229	CS 220 -235 SL	T8 Torque 1.5Nm (Max)		
	KRUZ 225 □ FH		P(5xD)	214	158	135						
			H(7xD)	259	203	180						
			L(10xD)	327	271	248						



# KRUZ "H" series flange + higher helix body & carbide insert

Indexable, Coolant Drill Series

Hole size range	Body Code No.	Shank $\Phi$ d / (L)	Cutting depth (Length x $\Phi$ D)	L1	L2	L3	Flanged dia. ( $\Phi$ Fd)	Insert Code No. to fit in body	Cap Screw	Torx driver	Set Screw	L-wrench							
$\Phi$ 23.0	YTDI 230 □ FH	25.0 (56)	T(3xD)	172	116	92	32	IDPH 230, IDPH 231, IDPH 232, IDPH 233, IDPH 234 IDFH 230, IDFH 231, IDFH 232, IDFH 233, IDFH 234 IDH 230, IDH 231, IDH 232, IDH 233, IDH 234 IDSH 230, IDSH 231, IDSH 232, IDSH 233, IDSH 234	CS 220 -235 SL	T8 Torque 1.5Nm (Max)									
$\sim\Phi$ 23.4	KRUZ 230 □ FH		P(5xD)	218	162	138		H(7xD)					264	208	184	L(10xD)	333	277	253
$\Phi$ 23.5	YTDI 235 □ FH		T(3xD)	174	118	94		IDPH 235, IDPH 236, IDPH 237, IDPH 238, IDPH 239 IDFH 235, IDFH 236, IDFH 237, IDFH 238, IDFH 239 IDH 235, IDH 236, IDH 237, IDH 238, IDH 239 IDSH 235, IDSH 236, IDSH 237, IDSH 238, IDSH 239					CS 240 -255 SL	M3x6	1.5mm				
$\sim\Phi$ 23.9	KRUZ 235 □ FH		P(5xD)	221	165	141		H(7xD)								268	212	188	L(10xD)
$\Phi$ 24.0	YTDI 240 □ FH	T(3xD)	181	121	96	IDPH 240, IDPH 241, IDPH 242, IDPH 243, IDPH 244 IDFH 240, IDFH 241, IDFH 242, IDFH 243, IDFH 244 IDH 240, IDH 241, IDH 242, IDH 243, IDH 244 IDSH 240, IDSH 241, IDSH 242, IDSH 243, IDSH 244	CS 260 -275 SL	T15 Torque 3.5Nm (Max)											
$\sim\Phi$ 24.4	KRUZ 240 □ FH	P(5xD)	229	169	144	H(7xD)					277	217				192	L(10xD)	349	289
$\Phi$ 24.5	YTDI 245 □ FH	T(3xD)	183	123	98	IDPH 245, IDPH 246, IDPH 247, IDPH 248, IDPH 249 IDFH 245, IDFH 246, IDFH 247, IDFH 248, IDFH 249 IDH 245, IDH 246, IDH 247, IDH 248, IDH 249 IDSH 245, IDSH 246, IDSH 247, IDSH 248, IDSH 249					CS 280 -295 SL	M4x8	2.0mm						
$\sim\Phi$ 24.9	KRUZ 245 □ FH	P(5xD)	232	172	147	H(7xD)								281	221	196	L(10xD)	355	295
$\Phi$ 25.0	YTDI 250 □ FH	T(3xD)	185	125	100	IDPH 250, IDPH 251, IDPH 252, IDPH 253, IDPH 254 IDFH 250, IDFH 251, IDFH 252, IDFH 253, IDFH 254 IDH 250, IDH 251, IDH 252, IDH 253L, IDH 254 IDSH 250, IDSH 251, IDSH 252, IDSH 253L, IDSH 254	CS 300 -315 SL	T20 Torque 5.0Nm (Max)											
$\sim\Phi$ 25.4	KRUZ 250 □ FH	P(5xD)	235	175	150	H(7xD)								285	225	200	L(10xD)	360	300
$\Phi$ 25.5	YTDI 255 □ FH	T(3xD)	188	128	102	IDPH 255, IDPH 256, IDPH 257, IDPH 258, IDPH 259 IDFH 255, IDFH 256, IDFH 257, IDFH 258, IDFH 259 IDH 255, IDH 256, IDH 257, IDH 258, IDH 259 IDSH 255, IDSH 256, IDSH 257, IDSH 258, IDSH 259					CS 320 -355 SL	T20 Torque 5.0Nm (Max)							
$\sim\Phi$ 25.9	KRUZ 255 □ FH	P(5xD)	239	179	153	H(7xD)									290	230	204	L(10xD)	367
$\Phi$ 26.0	YTDI 260 □ FH	T(3xD)	190	130	104	IDPH 260, IDPH 261, IDPH 262, IDPH 263, IDPH 264 IDFH 260, IDFH 261, IDFH 262, IDFH 263, IDFH 264 IDH 260, IDH 261, IDH 262, IDH 263, IDH 264 IDSH 260, IDSH 261, IDSH 262, IDSH 263, IDSH 264	CS 260 -275 SL	T15 Torque 3.5Nm (Max)											
$\sim\Phi$ 26.4	KRUZ 260 □ FH	P(5xD)	242	182	156	H(7xD)									294	234	208	L(10xD)	372
$\Phi$ 26.5	YTDI 265 □ FH	T(3xD)	193	133	106	IDPH 265, IDPH 266, IDPH 267, IDPH 268, IDPH 269 IDFH 265, IDFH 266, IDFH 267, IDFH 268, IDFH 269 IDH 265, IDH 266, IDH 267, IDH 268, IDH 269 IDSH 265, IDSH 266, IDSH 267, IDSH 268, IDSH 269					CS 260 -275 SL	T15 Torque 3.5Nm (Max)							
$\sim\Phi$ 26.9	KRUZ 265 □ FH	P(5xD)	246	186	159	H(7xD)									299	239	212	L(10xD)	379
$\Phi$ 27.0	YTDI 270 □ FH	T(3xD)	195	135	108	IDPH 270, IDPH 271, IDPH 272, IDPH 273, IDPH 274 IDFH 270, IDFH 271, IDFH 272, IDFH 273, IDFH 274 IDH 270, IDH 271, IDH 272, IDH 273, IDH 274 IDSH 270, IDSH 271, IDSH 272, IDSH 273, IDSH 274	CS 280 -295 SL	M4x8	2.0mm										
$\sim\Phi$ 27.4	KRUZ 270 □ FH	P(5xD)	249	189	162	H(7xD)				303					243	216	L(10xD)	384	324
$\Phi$ 27.5	YTDI 275 □ FH	T(3xD)	197	137	110	IDPH 275, IDPH 276, IDPH 277, IDPH 278, IDPH 279 IDFH 275, IDFH 276, IDFH 277, IDFH 278, IDFH 279 IDH 275, IDH 276, IDH 277, IDH 278, IDH 279 IDSH 275, IDSH 276, IDSH 277, IDSH 278, IDSH 279				CS 280 -295 SL	M4x8	2.0mm							
$\sim\Phi$ 27.9	KRUZ 275 □ FH	P(5xD)	252	192	165	H(7xD)							307	247	220	L(10xD)	390	330	303
$\Phi$ 28.0	YTDI 280 □ FH	T(3xD)	200	140	112	IDPH 280, IDPH 281, IDPH 282, IDPH 283, IDPH 284 IDFH 280, IDFH 281, IDFH 282, IDFH 283, IDFH 284 IDH 280, IDH 281, IDH 282, IDH 283, IDH 284 IDSH 280, IDSH 281, IDSH 282, IDSH 283, IDSH 284	CS 280 -295 SL	M4x8	2.0mm										
$\sim\Phi$ 28.4	KRUZ 280 □ FH	P(5xD)	256	196	168	H(7xD)							312	252	224	L(10xD)	396	336	308
$\Phi$ 28.5	YTDI 285 □ FH	T(3xD)	202	142	114	IDPH 285, IDPH 286, IDPH 287, IDPH 288, IDPH 289 IDFH 285, IDFH 286, IDFH 287, IDFH 288, IDFH 289 IDH 285, IDH 286, IDH 287, IDH 288, IDH 289 IDSH 285, IDSH 286, IDSH 287, IDSH 288, IDSH 289				CS 300 -315 SL	T20 Torque 5.0Nm (Max)								
$\sim\Phi$ 28.9	KRUZ 285 □ FH	P(5xD)	259	199	171	H(7xD)								316	256	228	L(10xD)	402	342
$\Phi$ 29.0	YTDI 290 □ FH	T(3xD)	205	145	116	IDPH 290, IDPH 291, IDPH 292, IDPH 293, IDPH 294 IDFH 290, IDFH 291, IDFH 292, IDFH 293, IDFH 294 IDH 290, IDH 291, IDH 292, IDH 293, IDH 294 IDSH 290, IDSH 291, IDSH 292, IDSH 293, IDSH 294	CS 300 -315 SL	T20 Torque 5.0Nm (Max)											
$\sim\Phi$ 29.4	KRUZ 290 □ FH	P(5xD)	263	203	174	H(7xD)									321	261	232	L(10xD)	408
$\Phi$ 29.5	YTDI 295 □ FH	T(3xD)	207	147	118	IDPH 295, IDPH 296, IDPH 297, IDPH 298, IDPH 299 IDFH 295, IDFH 296, IDFH 297, IDFH 298, IDFH 299 IDH 295, IDH 296, IDH 297, IDH 298, IDH 299 IDSH 295, IDSH 296, IDSH 297, IDSH 298, IDSH 299				CS 300 -315 SL	T20 Torque 5.0Nm (Max)								
$\sim\Phi$ 29.9	KRUZ 295 □ FH	P(5xD)	266	206	177	H(7xD)									325	265	236	L(10xD)	414
$\Phi$ 30.0	YTDI 300 □ FH	T(3xD)	209	149	120	IDPH 300, IDPH 301, IDPH 302, IDPH 303, IDPH 304 IDFH 300, IDFH 301, IDFH 302, IDFH 303, IDFH 304 IDH 300, IDH 301, IDH 302, IDH 303, IDH 304 IDSH 300, IDSH 301, IDSH 302, IDSH 303, IDSH 304	CS 300 -315 SL	T20 Torque 5.0Nm (Max)											
$\sim\Phi$ 30.4	KRUZ 300 □ FH	P(5xD)	269	209	180	H(7xD)									329	269	240	L(10xD)	419

Hole size range	Body Code No.	Shank $\Phi$ d / (L)	Cutting depth (Length x $\Phi$ D)	L1	L2	L3	Flanged dia. ( $\Phi$ Fd)	Insert Code No. to fit in body	Cap Screw	Torx driver	Set Screw	L-wrench							
$\Phi$ 30.5	YTDI 305 □ FH	32.0 (60)	T(3xD)	212	152	122	39	IDPH 305, IDPH 306, IDPH 307, IDPH 308, IDPH 309 IDFH 305, IDFH 306, IDFH 307, IDFH 308, IDFH 309 IDH 305, IDH 306, IDH 307, IDH 308, IDH 309 IDSH 305, IDSH 306, IDSH 307, IDSH 308, IDSH 309	CS 300 -315 SL		M4x8	2.0mm							
$\sim\Phi$ 30.9	KRUZ 305 □ FH		P(5xD)	273	213	183		H(7xD)					334	274	244	L(10xD)	426	366	336
$\Phi$ 31.0	YTDI 310 □ FH		T(3xD)	214	154	124		IDPH 310, IDPH 311, IDPH 312, IDPH 313, IDPH 314 IDFH 310, IDFH 311, IDFH 312, IDFH 313, IDFH 314 IDH 310, IDH 311, IDH 312, IDH 313, IDH 314 IDSH 310, IDSH 311, IDSH 312, IDSH 313, IDSH 314					CS 300 -315 SL		M4x8	2.0mm			
$\sim\Phi$ 31.4	KRUZ 310 □ FH		P(5xD)	276	216	186		H(7xD)									338	278	248
$\Phi$ 31.5	YTDI 315 □ FH	T(3xD)	217	157	126	IDPH 315, IDPH 316, IDPH 317, IDPH 318, IDPH 319 IDFH 315, IDFH 316, IDFH 317, IDFH 318, IDFH 319 IDH 315, IDH 316, IDH 317, IDH 318, IDH 319 IDSH 315, IDSH 316, IDSH 317, IDSH 318, IDSH 319	CS 320 -355 SL	T20 Torque 5.0Nm (Max)		M5x10	2.5mm								
$\sim\Phi$ 31.9	KRUZ 315 □ FH	P(5xD)	280	220	189	H(7xD)						343					283	252	L(10xD)
$\Phi$ 32.0	YTDI 320 □ FH	T(3xD)	219	159	128	IDPH 320, IDPH 321, IDPH 322, IDPH 323, IDPH 324 IDFH 320, IDFH 321, IDFH 322, IDFH 323, IDFH 324 IDH 320, IDH 321, IDH 322, IDH 323, IDH 324 IDSH 320, IDSH 321, IDSH 322, IDSH 323, IDSH 324						CS 320 -355 SL	T20 Torque 5.0Nm (Max)		M5x10	2.5mm			
$\sim\Phi$ 32.4	KRUZ 320 □ FH	P(5xD)	283	223	192	H(7xD)											347	287	256
$\Phi$ 32.5	YTDI 325 □ FH	T(3xD)	221	161	130	IDPH 325, IDPH 326, IDPH 327, IDPH 328, IDPH 329 IDFH 325, IDFH 326, IDFH 327, IDFH 328, IDFH 329 IDH 325, IDH 326, IDH 327, IDH 328, IDH 329 IDSH 325, IDSH 326, IDSH 327, IDSH 328, IDSH 329	CS 320 -355 SL	T20 Torque 5.0Nm (Max)		M5x10	2.5mm								
$\sim\Phi$ 32.9	KRUZ 325 □ FH	P(5xD)	286	226	195	H(7xD)											351	291	260
$\Phi$ 33.0	YTDI 330 □ FH	T(3xD)	224	164	132	IDPH 330, IDPH 331, IDPH 332, IDPH 333, IDPH 334 IDFH 330, IDFH 331, IDFH 332, IDFH 333, IDFH 334 IDH 330, IDH 331, IDH 332, IDH 333, IDH 334 IDSH 330, IDSH 331, IDSH 332, IDSH 333, IDSH 334						CS 320 -355 SL	T20 Torque 5.0Nm (Max)		M5x10	2.5mm			
$\sim\Phi$ 33.4	KRUZ 330 □ FH	P(5xD)	290	230	198	H(7xD)											356	296	264
$\Phi$ 33.5	YTDI 335 □ FH	T(3xD)	226	166	134	IDPH 335, IDPH 336, IDPH 337, IDPH 338, IDPH 339 IDFH 335, IDFH 336, IDFH 337, IDFH 338, IDFH 339 IDH 335, IDH 336, IDH 337, IDH 338, IDH 339 IDSH 335, IDSH 336, IDSH 337, IDSH 338, IDSH 339	CS 320 -355 SL	T20 Torque 5.0Nm (Max)		M5x10	2.5mm								
$\sim\Phi$ 33.9	KRUZ 335 □ FH	P(5xD)	293	233	201	H(7xD)											360	300	268
$\Phi$ 34.0	YTDI 340 □ FH	T(3xD)	239	169	136	IDPH 340, IDPH 341, IDPH 342, IDPH 343, IDPH 344 IDFH 340, IDFH 341, IDFH 342, IDFH 343, IDFH 344 IDH 340, IDH 341, IDH 342, IDH 343, IDH 344 IDSH 340, IDSH 341, IDSH 342, IDSH 343, IDSH 344						CS 320 -355 SL	T20 Torque 5.0Nm (Max)		M5x10	2.5mm			
$\sim\Phi$ 34.4	KRUZ 340 □ FH	P(5xD)	307	237	204	H(7xD)											375	305	272
$\Phi$ 34.5	YTDI 345 □ FH	T(3xD)	241	171	138	IDPH 345, IDPH 346, IDPH 347, IDPH 348, IDPH 349 IDFH 345, IDFH 346, IDFH 347, IDFH 348, IDFH 349 IDH 345, IDH 346, IDH 347, IDH 348, IDH 349 IDSH 345, IDSH 346, IDSH 347, IDSH 348, IDSH 349	CS 320 -355 SL	T20 Torque 5.0Nm (Max)		M5x10	2.5mm								
$\sim\Phi$ 34.9	KRUZ 345 □ FH	P(5xD)	310	240	207	H(7xD)											379	309	276
$\Phi$ 35.0	YTDI 350 □ FH	T(3xD)	243	173	140	IDPH 350, IDPH 351, IDPH 352, IDPH 353, IDPH 354 IDFH 350, IDFH 351, IDFH 352, IDFH 353, IDFH 354 IDH 350, IDH 351, IDH 352, IDH 353, IDH 354 IDSH 350, IDSH 351, IDSH 352, IDSH 353, IDSH 354						CS 320 -355 SL	T20 Torque 5.0Nm (Max)		M5x10	2.5mm			
$\sim\Phi$ 35.4	KRUZ 350 □ FH	P(5xD)	313	243	210	H(7xD)											383	313	280
$\Phi$ 35.5	YTDI 355 □ FH	T(3xD)	246	176	142	IDPH 355, IDPH 356, IDPH 357, IDPH 358, IDPH 359 IDFH 355, IDFH 356, IDFH 357, IDFH 358, IDFH 359 IDH 355, IDH 356, IDH 357, IDH 358, IDH 359 IDSH 355, IDSH 356, IDSH 357, IDSH 358, IDSH 359	CS 320 -355 SL	T20 Torque 5.0Nm (Max)		M5x10	2.5mm								
$\sim\Phi$ 35.9	KRUZ 355 □ FH	P(5xD)	317	247	213	H(7xD)											388	318	284
$\Phi$ 36.0	YTDI 360 □ FH	T(3xD)	248	178	144	IDPH 360, IDPH 361, IDPH 362, IDPH 363, IDPH 364 IDFH 360, IDFH 361, IDFH 362, IDFH 363, IDFH 364 IDH 360, IDH 361, IDH 362, IDH 363, IDH 364 IDSH 360, IDSH 361, IDSH 362, IDSH 363, IDSH 364						CS 360 -395 SL	T20 Torque 5.0Nm (Max)		M5x10	2.5mm			
$\sim\Phi$ 36.4	KRUZ 360 □ FH	P(5xD)	320	250	216	H(7xD)											392	322	288
$\Phi$ 36.5	YTDI 365 □ FH	T(3xD)	251	1															





# KRUZ "H" series flange + higher helix body & carbide insert

Indexable, Coolant Drill Series

Hole size range	Body Code No.	Shank $\Phi d / (L)$	Cutting depth (Length x $\Phi D$ )	L1	L2	L3	Flanged dia. ( $\Phi Fd$ )	Insert Code No. to fit in body	Cap Screw	Torx driver	Set Screw	L-wrench
$\Phi 38.0$	YTDI 380 □ FH	40.0 (70)	T(3xD) 258 188 152	55	IDPH 380, IDPH 381, IDPH 382, IDPH 383, IDPH 384 IDFH 380, IDFH 381, IDFH 382, IDFH 383, IDFH 384 IDH 380, IDH 381, IDH 382, IDH 383, IDH 384 IDSH 380, IDSH 381, IDSH 382, IDSH 383, IDSH 384	CS 360 -395 SL	M5x10	2.5mm	T20 Torque 5.0Nm (Max)	✓	✓	
$\sim \Phi 38.4$	KRUZ 380 □ FH		P(5xD) 334 264 228									
			H(7xD) 410 340 304									
			L(10xD) 524 454 418									
$\Phi 38.5$	YTDI 385 □ FH		T(3xD) 260 196 154									
$\sim \Phi 38.9$	KRUZ 385 □ FH		P(5xD) 337 267 231									
			H(7xD) 414 344 308									
			L(10xD) 530 460 424									
$\Phi 39.0$	YTDI 390 □ FH		T(3xD) 263 193 156									
$\sim \Phi 39.4$	KRUZ 390 □ FH		P(5xD) 341 271 234									
			H(7xD) 419 349 312									
			L(10xD) 536 466 429									
$\Phi 39.5$	YTDI 395 □ FH		T(3xD) 265 195 158									
$\sim \Phi 39.9$	KRUZ 395 □ FH		P(5xD) 344 274 237									
			H(7xD) 423 353 316									
			L(10xD) 542 472 435									
$\Phi 40.0$	YTDI 400 □ FH	T(3xD) 267 197 160	CS 400 -445 SL	M6x12	3.0mm							
$\sim \Phi 40.4$	KRUZ 400 □ FH	P(5xD) 347 277 240										
		H(7xD) 427 357 320										
		L(10xD) 547 477 440										
$\Phi 40.5$	YTDI 405 □ FH	T(3xD) 270 200 162										
$\sim \Phi 40.9$	KRUZ 405 □ FH	P(5xD) 351 281 243										
		H(7xD) 432 362 324										
		L(10xD) 554 484 446										
$\Phi 41.0$	YTDI 410 □ FH	T(3xD) 272 202 164										
$\sim \Phi 41.4$	KRUZ 410 □ FH	P(5xD) 354 284 246										
		H(7xD) 436 366 328										
		L(10xD) 559 489 451										
$\Phi 41.5$	YTDI 415 □ FH	T(3xD) 275 205 166										
$\sim \Phi 41.9$	KRUZ 415 □ FH	P(5xD) 358 288 249										
		H(7xD) 441 371 332										
		L(10xD) 566 496 457										
$\Phi 42.0$	YTDI 420 □ FH	T(3xD) 277 207 168	CS 450 -500 SL	M6x12	3.0mm							
$\sim \Phi 42.4$	KRUZ 420 □ FH	P(5xD) 361 291 252										
		H(7xD) 445 375 336										
		L(10xD) 571 501 462										
$\Phi 42.5$	YTDI 425 □ FH	T(3xD) 279 209 170										
$\sim \Phi 42.9$	KRUZ 425 □ FH	P(5xD) 364 294 255										
		H(7xD) 449 379 340										
		L(10xD) 577 507 468										
$\Phi 43.0$	YTDI 430 □ FH	T(3xD) 282 212 172										
$\sim \Phi 43.4$	KRUZ 430 □ FH	P(5xD) 368 298 258										
		H(7xD) 454 384 344										
		L(10xD) 583 513 473										
$\Phi 43.5$	YTDI 435 □ FH	T(3xD) 284 214 174										
$\sim \Phi 43.9$	KRUZ 435 □ FH	P(5xD) 371 301 261										
		H(7xD) 458 388 348										
		L(10xD) 589 519 479										
$\Phi 44.0$	YTDI 440 □ FH	T(3xD) 287 217 176	CS 450 -500 SL	M6x12	3.0mm							
$\sim \Phi 44.4$	KRUZ 440 □ FH	P(5xD) 375 305 264										
		H(7xD) 463 393 352										
		L(10xD) 595 525 484										
$\Phi 44.5$	YTDI 445 □ FH	T(3xD) 289 219 178										
$\sim \Phi 44.9$	KRUZ 445 □ FH	P(5xD) 378 308 267										
		H(7xD) 467 397 356										
		L(10xD) 601 531 490										
$\Phi 45.0$	YTDI 450 □ FH	T(3xD) 291 221 180										
$\sim \Phi 45.4$	KRUZ 450 □ FH	P(5xD) 381 311 270										
		H(7xD) 471 401 360										
		L(10xD) 606 536 495										

Hole size range	Body Code No.	Shank $\Phi d / (L)$	Cutting depth (Length x $\Phi D$ )	L1	L2	L3	Flanged dia. ( $\Phi Fd$ )	Insert Code No. to fit in body	Cap Screw	Torx driver	Set Screw	L-wrench		
$\Phi 45.5$	YTDI 455 □ FH	40.0 (70)	T(3xD) 294 224 182	55	IDPH 455, IDPH 456, IDPH 457, IDPH 458, IDPH 459 IDFH 455, IDFH 456, IDFH 457, IDFH 458, IDFH 459 IDH 455, IDH 456, IDH 457, IDH 458, IDH 459 IDSH 455, IDSH 456, IDSH 457, IDSH 458, IDSH 459	CS 450 -500 SL	M6x12	3.0mm	T20 Torque 5.0Nm (Max)	✓	✓			
$\sim \Phi 45.9$	KRUZ 455 □ FH		P(5xD) 385 315 273											
			H(7xD) 476 406 364											
			L(10xD) 613 543 501											
$\Phi 46.0$	YTDI 460 □ FH		T(3xD) 296 226 184											
$\sim \Phi 46.4$	KRUZ 460 □ FH		P(5xD) 388 318 276											
			H(7xD) 480 410 368											
			L(10xD) 618 548 506											
$\Phi 46.5$	YTDI 465 □ FH		T(3xD) 299 229 186											
$\sim \Phi 46.9$	KRUZ 465 □ FH		P(5xD) 392 322 279											
			H(7xD) 485 415 372											
			L(10xD) 625 555 512											
$\Phi 47.0$	YTDI 470 □ FH		T(3xD) 301 231 188									CS 450 -500 SL	M6x12	3.0mm
$\sim \Phi 47.4$	KRUZ 470 □ FH		P(5xD) 395 325 282											
			H(7xD) 489 419 376											
			L(10xD) 630 560 517											
$\Phi 47.5$	YTDI 475 □ FH	T(3xD) 303 233 190												
$\sim \Phi 47.9$	KRUZ 475 □ FH	P(5xD) 398 328 285												
		H(7xD) 493 423 380												
		L(10xD) 636 566 523												
$\Phi 48.0$	YTDI 480 □ FH	T(3xD) 306 236 192												
$\sim \Phi 48.4$	KRUZ 480 □ FH	P(5xD) 402 332 288												
		H(7xD) 498 428 384												
		L(10xD) 642 572 528												
$\Phi 48.5$	YTDI 485 □ FH	T(3xD) 308 238 194												
$\sim \Phi 48.9$	KRUZ 485 □ FH	P(5xD) 405 335 291												
		H(7xD) 502 432 388												
		L(10xD) 648 578 534												
$\Phi 49.0$	YTDI 490 □ FH	T(3xD) 311 241 196	CS 450 -500 SL	M6x12	3.0mm									
$\sim \Phi 49.4$	KRUZ 490 □ FH	P(5xD) 409 339 294												
		H(7xD) 507 437 392												
		L(10xD) 654 584 539												
$\Phi 49.5$	YTDI 495 □ FH	T(3xD) 313 243 198												
$\sim \Phi 49.9$	KRUZ 495 □ FH	P(5xD) 412 342 297												
		H(7xD) 511 441 396												
		L(10xD) 660 590 545												
$\Phi 50.0$	YTDI 500 □ FH	T(3xD) 315 245 200												
$\sim \Phi 50.4$	KRUZ 500 □ FH	P(5xD) 415 345 300												
		H(7xD) 515 445 400												
		L(10xD) 665 595 550												

### KRUZ-FH Drills, Cutting Speed Recommendation

Material Group	Drill Dia. Condition	$\Phi 8 \sim 16\text{mm}$		$\Phi 16 \sim 25\text{mm}$		$\Phi 25 \sim 32\text{mm}$		$\Phi 32 \sim 40\text{mm}$		$\Phi 40 \sim 50\text{mm}$	
		Speed (m/min)	Feed (mm/rev)	Speed (m/min)	Feed (mm/rev)	Speed (m/min)	Feed (mm/rev)	Speed (m/min)	Feed (mm/rev)	Speed (m/min)	Feed (mm/rev)
Grey cast iron (FC)		80~150	0.20~0.30	80~150	0.25~0.45	80~160	0.35~0.55	90~200	0.34~0.58	90~200	0.38~0.60
Nodular cast iron (FCD)		80~140	0.15~0.25	80~140	0.22~0.45	80~150	0.32~0.52	90~160	0.35~0.62	90~200	0.38~0.60
Carbon steel (S45C)		80~140	0.15~0.30	80~140	0.16~0.40	80~150	0.20~0.40	80~150	0.22~0.48	80~160	0.25~0.54
Alloy steel (SCM440)		70~140	0.15~0.30	70~140	0.15~0.40	70~140	0.18~0.40	80~140	0.25~0.47	80~140	0.27~0.52
Hardened steel (SKD11)		40~50	0.10~0.20	40~50	0.12~0.28	40~50	0.16~0.35	40~60	0.20~0.38	40~60	0.22~0.42
Stainless steel (SUS)		30~40	0.10~0.20	35~50	0.10~0.22	35~50	0.15~0.28	40~55	0.18~0.30	40~55	0.22~0.32
Aluminum 130HB (AL)		120~200	0.20~0.30	120~200	0.25~0.40	120~200	0.30~0.45	120~200	0.30~0.45	120~200	0.30~0.50

☞ This data is recommended for 3xDia. And should be reduced about 15~20% for 5xD, 7xD, 10xD drills.

☞ The data is normally suggested for oil-mist(MQL) coolant condition and also possible to run in other normal condition if machining environment like clamping etc. are secured in good.

Indexable, Coolant Drill Series

# KRUZ "K" series drill body & insert

## Caution !!!

"K" series inserts (IDFK or IDPK) should use only with "K" series body (KRUZ-SLK or FSLK) to avoid drilling failure.

### IDFK Carbide insert

- Carbide insert completely grinded by CNC program
- Patented 140°+170° dual angle flat bottom point
- TiAlN coated insert offers wear resistance and higher feed rate
- Designed exclusively for structural beam, angle or single plate drilling



### IDPK Carbide insert

- Carbide insert completely grinded by CNC program
- Patented 130°+150° dual point angle
- TiAlN coated insert offers wear resistance and higher feed rate
- Appropriate insert design for stack plates drilling



(for stacked plates)

### KRUZ-SLK Drill body

- Rigid drill body made of special premium steel and heat treated
- TiN coated body to enable longer tool life and higher lubricity
- Special flute design to increase faster chip's ejection rate
- Enabling to mount 0.5mm inclusive both IDFK & IDPK inserts
- Stubby length to perform maximum drilling ability of structural machining
- Internal coolant fed

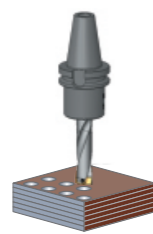
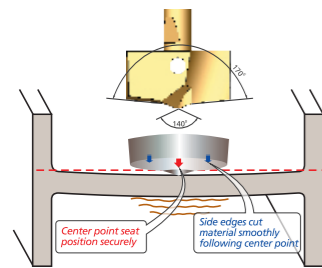

(Plate)

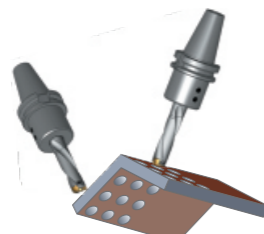

(Angle)

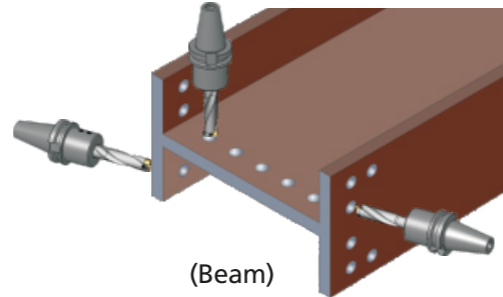

(Beam)



# KRUZ "K" series Stubby type & 3D drill body & insert, Metric



KRUZ-SLK

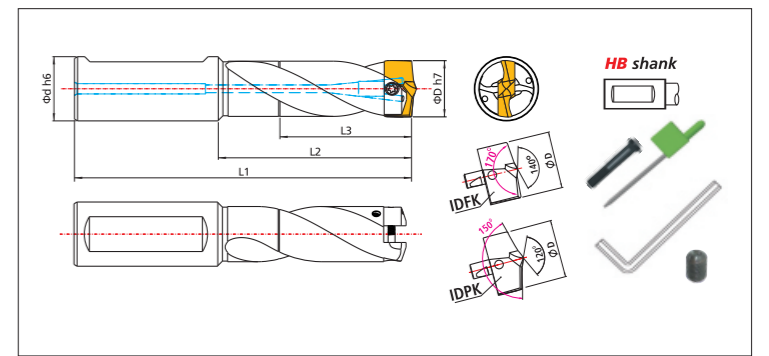
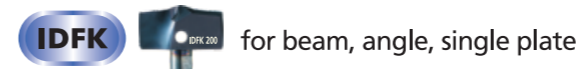

## Exclusively designed for Structural machining

Hole (Φ) mm	Body Code Stubby type	Dimension			Body Code 3D	Dimension			Shank Ø (L)	Cap Screw	Torx driver	Set Screw	L-wrench		
		L1	L2	L3		L1	L2	L3							
12.0~12.4	KRUZ 120 L3=50 SLK	110	62	62	KRUZ 120T SLK	105	57	16 (48)	16 (48)	CS 120 -135 SL	T6 Torque 0.6Nm (Max)				
12.5~12.9	KRUZ 125 L3=50 SLK				KRUZ 125T SLK	110	62							50	
13.0~13.4	KRUZ 130 L3=50 SLK				KRUZ 130T SLK	110	62							50	
13.5~13.9	KRUZ 135 L3=50 SLK				KRUZ 135T SLK	115	67							55	
14.0~14.4	KRUZ 140 L3=50 SLK				KRUZ 140T SLK	115	67							55	
14.5~14.9	KRUZ 145 L3=50 SLK	KRUZ 145T SLK	115	67	55	125	75	60	CS 140 -155 SL	T7 Torque 0.9Nm (Max)	M2.5x4	1.3mm			
15.0~15.4	KRUZ 150 L3=50 SLK	KRUZ 150T SLK	125	75	60										
15.5~15.9	KRUZ 155 L3=50 SLK	KRUZ 155T SLK	125	75	60										
16.0~16.4	KRUZ 160 L3=50 SLK	KRUZ 160T SLK	130	80	62										
16.5~16.9	KRUZ 165 L3=50 SLK	KRUZ 165T SLK	130	80	62										
17.0~17.4	KRUZ 170 L3=50 SLK	KRUZ 170T SLK	118	68	68	140	90	70	CS 180 -195 SL	T8 Torque 1.5Nm (Max)	M3x6	1.5mm			
17.5~17.9	KRUZ 175 L3=50 SLK	KRUZ 175T SLK											140	90	70
18.0~18.4	KRUZ 180 L3=50 SLK	KRUZ 180T SLK											140	90	70
18.5~18.9	KRUZ 185 L3=50 SLK	KRUZ 185T SLK											140	90	70
19.0~19.4	KRUZ 190 L3=50 SLK	KRUZ 190T SLK											140	90	70
19.5~19.9	KRUZ 195 L3=50 SLK	KRUZ 195T SLK	130	74	74	160	104	80	CS 220 -235 SL	T15 Torque 3.5Nm (Max)	M4x8	2.0mm			
20.0~20.4	KRUZ 200 L3=50 SLK	KRUZ 200T SLK											160	104	80
20.5~20.9	KRUZ 205 L3=50 SLK	KRUZ 205T SLK											160	104	80
21.0~21.4	KRUZ 210 L3=50 SLK	KRUZ 210T SLK											160	104	80
21.5~21.9	KRUZ 215 L3=50 SLK	KRUZ 215T SLK											160	104	80
22.0~22.4	KRUZ 220 L3=50 SLK	KRUZ 220T SLK	136	76	76	170	110	84	CS 240 -255 SL						
22.5~22.9	KRUZ 225 L3=50 SLK	KRUZ 225T SLK											170	110	84
23.0~23.4	KRUZ 230 L3=50 SLK	KRUZ 230T SLK											170	110	84
23.5~23.9	KRUZ 235 L3=50 SLK	KRUZ 235T SLK											170	110	84
24.0~24.4	KRUZ 240 L3=50 SLK	KRUZ 240T SLK											170	110	84
24.5~24.9	KRUZ 245 L3=50 SLK	KRUZ 245T SLK	140	80	80	180	120	90	CS 260 -275 SL						
25.0~25.4	KRUZ 250 L3=50 SLK	KRUZ 250T SLK											180	120	90
25.5~25.9	KRUZ 255 L3=50 SLK	KRUZ 255T SLK											180	120	90
26.0~26.4	KRUZ 260 L3=50 SLK	KRUZ 260T SLK											180	120	90
26.5~26.9	KRUZ 265 L3=50 SLK	KRUZ 265T SLK											180	120	90
27.0~27.4	KRUZ 270 L3=50 SLK	KRUZ 270T SLK	190	130	130	190	130	100	CS 280 -295 SL						
27.5~27.9	KRUZ 275 L3=50 SLK	KRUZ 275T SLK											190	130	100
28.0~28.4	KRUZ 280 L3=50 SLK	KRUZ 280T SLK											190	130	100
28.5~28.9	KRUZ 285 L3=50 SLK	KRUZ 285T SLK											190	130	100
29.0~29.4	KRUZ 290 L3=50 SLK	KRUZ 290T SLK											190	130	100
29.5~29.9	KRUZ 295 L3=50 SLK	KRUZ 295T SLK	190	130	100										

Size not shown on above is available upon request.



Exclusively designed for Structural machining

Hole (Φ) mm	Body Code Stubby type	Dimension			Body Code 3D	Dimension			Shank Ød (L)	IDFK	IDPK	Cap Screw	Torx driver	Set Screw	L-wrench										
		L1	L2	L3		L1	L2	L3																	
30.0~30.4	KRUZ 300 L3=70 SLK	155	95	70	KRUZ 300T SLK	200	140	110	32 (60)	IDFK 300-304	CS 300 -315 SL	M4x8		2.0mm											
30.5~30.9	KRUZ 305 L3=70 SLK				IDFK 305-309																				
31.0~31.4	KRUZ 310 L3=70 SLK				IDFK 310-314																				
31.5~31.9	KRUZ 315 L3=70 SLK				IDFK 315-319																				
32.0~32.4	KRUZ 320 L3=70 SLK				IDFK 320-324																				
32.5~32.9	KRUZ 325 L3=70 SLK				IDFK 325-329																				
33.0~33.4	KRUZ 330 L3=70 SLK				IDFK 330-334																				
33.5~33.9	KRUZ 335 L3=70 SLK				IDFK 335-339																				
34.0~34.4	KRUZ 340 L3=80 SLK				180					110					80	KRUZ 340T SLK	230	160	120	32 (60)	IDFK 340-344	CS 320 -355 SL	M5x10		2.5mm
34.5~34.9	KRUZ 345 L3=80 SLK	IDFK 345-349																							
35.0~35.4	KRUZ 350 L3=80 SLK	IDFK 350-354																							
35.5~35.9	KRUZ 355 L3=80 SLK	IDFK 355-359																							
36.0~36.4	KRUZ 360 L3=80 SLK	IDFK 360-364																							
36.5~36.9	KRUZ 365 L3=80 SLK	IDFK 365-369																							
37.0~37.4	KRUZ 370 L3=80 SLK	IDFK 370-374																							
37.5~37.9	KRUZ 375 L3=80 SLK	IDFK 375-379																							
38.0~38.4	KRUZ 380 L3=80 SLK	IDFK 380-384																							
38.5~38.9	KRUZ 385 L3=80 SLK	IDFK 385-389																							
39.0~39.4	KRUZ 390 L3=80 SLK	IDFK 390-394																							
39.5~39.9	KRUZ 395 L3=80 SLK	IDFK 395-399																							
40.0~40.4	KRUZ 400 L3=80 SLK	185	115	80		KRUZ 400T SLK	250	180	130		40 (70)	IDFK 400-404	CS 360 -395 SL	M6x12							3.0mm				
40.5~40.9	KRUZ 405 L3=80 SLK					IDFK 405-409																			
41.0~41.4	KRUZ 410 L3=80 SLK					IDFK 410-414																			
41.5~41.9	KRUZ 415 L3=80 SLK					IDFK 415-419																			
42.0~42.4	KRUZ 420 L3=80 SLK					IDFK 420-424																			
42.5~42.9	KRUZ 425 L3=80 SLK					IDFK 425-429																			
43.0~43.4	KRUZ 430 L3=80 SLK				IDFK 430-434																				
43.5~43.9	KRUZ 435 L3=80 SLK				IDFK 435-439																				
44.0~44.4	KRUZ 440 L3=80 SLK				IDFK 440-444																				
44.5~44.9	KRUZ 445 L3=80 SLK				IDFK 445-449																				
45.0~45.4	KRUZ 450 L3=80 SLK	200	130	90	KRUZ 450T SLK	270	200	143	40 (70)	IDFK 450-454	CS 400 -445 SL	M6x12		3.0mm											
45.5~45.9	KRUZ 455 L3=80 SLK				IDFK 455-459																				
46.0~46.4	KRUZ 460 L3=80 SLK				IDFK 460-464																				
46.5~46.9	KRUZ 465 L3=80 SLK				IDFK 465-469																				
47.0~47.4	KRUZ 470 L3=80 SLK				IDFK 470-474																				
47.5~47.9	KRUZ 475 L3=80 SLK				IDFK 475-479																				
48.0~48.4	KRUZ 480 L3=90 SLK				IDFK 480-484																				
48.5~48.9	KRUZ 485 L3=90 SLK				IDFK 485-489																				
49.0~49.4	KRUZ 490 L3=90 SLK				IDFK 490-494																				
49.5~49.9	KRUZ 495 L3=90 SLK				IDFK 495-499																				
50.0~50.4	KRUZ 500 L3=90 SLK	IDFK 500-504																							



KRUZ-SLK



IDFK

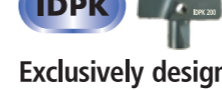

IDPK

for beam, angle, single plate

for stacked plate

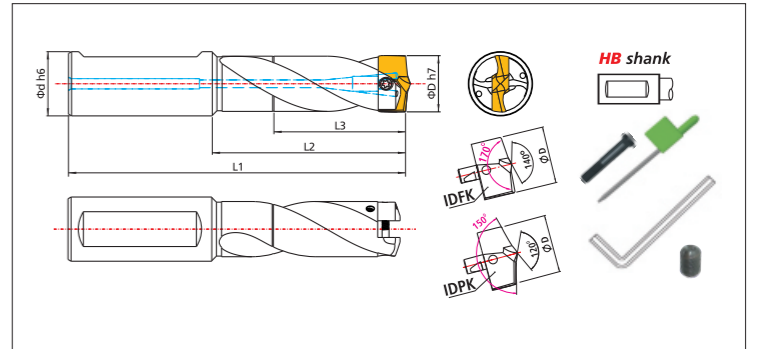

Exclusively designed for Structural machining

Hole (Φ) decimal	Body Code	Shank Ød (L)	Dimension			Insert IDFK	Insert IDPK	Alternative Metric body		
			L1	L2	L3					
.4724~.4917	KRUZ .4724 SLK	5/8 (15.875mm) (48)	4.3307 (110mm)	2.4409 (62mm)	IDFK 31/64"(12.30mm)	IDPK 31/64"(12.30mm)	KRUZ 120 L3=50 SLK			
.4921~.5114	KRUZ .4921 SLK				IDFK 1/2"(12.70mm)	IDPK 1/2"(12.70mm)	KRUZ 125 L3=50 SLK			
.5118~.5311	KRUZ .5118 SLK				IDFK 33/64"(13.10mm)	IDPK 33/64"(13.10mm)	KRUZ 130 L3=50 SLK			
.5315~.5508	KRUZ .5315 SLK				IDFK 17/32"(13.49mm)	IDPK 17/32"(13.49mm)	KRUZ 135 L3=50 SLK			
.5512~.5705	KRUZ .5512 SLK				IDFK 9/16"(14.29mm)	IDPK 9/16"(14.29mm)	KRUZ 140 L3=50 SLK			
.5709~.5902	KRUZ .5709 SLK				IDFK 37/64"(14.68mm)	IDPK 37/64"(14.68mm)	KRUZ 145 L3=50 SLK			
.5906~.6098	KRUZ .5906 SLK				IDFK 19/32"(15.08mm), IDFK 39/64"(15.48mm)	IDPK 19/32"(15.08mm), IDPK 39/64"(15.48mm)	KRUZ 150 L3=50 SLK			
.6102~.6295	KRUZ .6102 SLK				IDFK 5/8"(15.88mm)	IDPK 5/8"(15.88mm)	KRUZ 155 L3=50 SLK			
.6299~.6492	KRUZ .6299 SLK				IDFK 41/64"(16.27mm)	IDPK 41/64"(16.27mm)	KRUZ 160 L3=50 SLK			
.6496~.6689	KRUZ .6496 SLK	3/4 (19.05mm) (50)	4.5276 (115mm)	2.5591 (65mm)	IDFK 21/32"(16.67mm)	IDPK 21/32"(16.67mm)	KRUZ 165 L3=50 SLK			
.6693~.6886	KRUZ .6693 SLK				IDFK 43/64"(17.07mm), IDFK 87/128"(17.46mm)	IDPK 43/64"(17.07mm), IDPK 87/128"(17.46mm)	KRUZ 170 L3=50 SLK			
.6890~.7083	KRUZ .6890 SLK				IDFK 45/64"(17.86mm)	IDPK 45/64"(17.86mm)	KRUZ 175 L3=50 SLK			
.7087~.7280	KRUZ .7087 SLK				IDFK 23/32"(18.26mm)	IDPK 23/32"(18.26mm)	KRUZ 180 L3=50 SLK			
.7283~.7476	KRUZ .7283 SLK				IDFK 47/64"(18.65mm)	IDPK 47/64"(18.65mm)	KRUZ 185 L3=50 SLK			
.7480~.7673	KRUZ .7480 SLK				IDFK 3/4(19.05mm), IDFK 49/64"(19.45mm)	IDPK 3/4(19.05mm), IDPK 49/64"(19.45mm)	KRUZ 190 L3=50 SLK			
.7677~.7870	KRUZ .7677 SLK				IDFK 25/32"(19.84mm)	IDPK 25/32"(19.84mm)	KRUZ 195 L3=50 SLK			
.7874~.8067	KRUZ .7874 SLK				IDFK 51/64"(20.24mm)	IDPK 51/64"(20.24mm)	KRUZ 200 L3=50 SLK			
.8071~.8264	KRUZ .8071 SLK				1" (25.4mm) (56)	5.1181 (130mm)	2.9134 (74mm)	IDFK 13/16"(20.64mm)	IDPK 13/16"(20.64mm)	KRUZ 205 L3=50 SLK
.8268~.8461	KRUZ .8268 SLK	IDFK 27/32"(21.43mm)	IDPK 27/32"(21.43mm)	KRUZ 210 L3=50 SLK						
.8465~.8657	KRUZ .8465 SLK	IDFK 55/64"(21.83mm)	IDPK 55/64"(21.83mm)	KRUZ 215 L3=50 SLK						
.8661~.8854	KRUZ .8661 SLK	IDFK 7/8"(22.23mm)	IDPK 7/8"(22.23mm)	KRUZ 220 L3=50 SLK						
.8858~.9051	KRUZ .8858 SLK	IDFK 57/64"(22.62mm)	IDPK 57/64"(22.62mm)	KRUZ 225 L3=50 SLK						
.9055~.9248	KRUZ .9055 SLK	IDFK 29/32"(23.02mm), IDFK 59/64"(23.42mm)	IDPK 29/32"(23.02mm), IDPK 59/64"(23.42mm)	KRUZ 230 L3=50 SLK						
.9252~.9445	KRUZ .9252 SLK	IDFK 15/16"(23.81mm)	IDPK 15/16"(23.81mm)	KRUZ 235 L3=50 SLK						
.9646~.9839	KRUZ .9646 SLK	1 1/4 (31.75mm) (60)	5.3543 (136mm)	2.9921 (76mm)				IDFK 31/32"(24.61mm)	IDPK 31/32"(24.61mm)	KRUZ 245 L3=50 SLK
.9843~1.0035	KRUZ .9843 SLK							IDFK 63/64"(25.00mm), IDFK 1"(25.4mm)	IDPK 63/64"(25.00mm), IDPK 1"(25.4mm)	KRUZ 250 L3=50 SLK
1.0039~1.0232	KRUZ 1.0039 SLK				IDFK 1-1/64"(25.80mm)	IDPK 1-1/64"(25.80mm)	KRUZ 255 L3=50 SLK			
1.0236~1.0429	KRUZ 1.0236 SLK				IDFK 1-1/32"(26.19mm)	IDPK 1-1/32"(26.19mm)	KRUZ 260 L3=50 SLK			
1.0433~1.0626	KRUZ 1.0433 SLK				IDFK 1-3/64"(26.59mm), IDFK 1-1/16"(26.99mm)	IDPK 1-3/64"(26.59mm), IDPK 1-1/16"(26.99mm)	KRUZ 265 L3=50 SLK			
1.0827~1.1020	KRUZ 1.0827 SLK				IDFK 1-3/32"(27.78mm)	IDPK 1-3/32"(27.78mm)	KRUZ 275 L3=50 SLK			
1.1024~1.1217	KRUZ 1.1024 SLK				IDFK 1-7/64"(28.18mm)	IDPK 1-7/64"(28.18mm)	KRUZ 280 L3=50 SLK			
1.1220~1.1413	KRUZ 1.1220 SLK				IDFK 1-1/8"(28.58mm)	IDPK 1-1/8"(28.58mm)	KRUZ 285 L3=50 SLK			
1.1417~1.1610	KRUZ 1.1417 SLK				IDFK 1-5/32"(29.37mm)	IDPK 1-5/32"(29.37mm)	KRUZ 290 L3=50 SLK			
1.1811~1.2004	KRUZ 1.1811 SLK	6.1024 (155mm)	3.7402 (95mm)	2.7559 (70mm)	IDFK 1-3/16"(30.16mm)	IDPK 1-3/16"(30.16mm)	KRUZ 300 L3=50 SLK			
1.2008~1.2201	KRUZ 1.2008 SLK				IDFK 1-7/32"(30.96mm)	IDPK 1-7/32"(30.96mm)	KRUZ 305 L3=50 SLK			
1.2402~1.2594	KRUZ 1.2402 SLK				IDFK 1-1/4"(31.75mm)	IDPK 1-1/4"(31.75mm)	KRUZ 315 L3=50 SLK			
1.2795~1.2988	KRUZ 1.2795 SLK				IDFK 1-9/32"(32.54mm)	IDPK 1-9/32"(32.54mm)	KRUZ 325 L3=50 SLK			
1.2992~1.3185	KRUZ 1.2992 SLK				IDFK 1-5/16"(33.34mm)	IDPK 1-5/16"(33.34mm)	KRUZ 330 L3=50 SLK			
1.3386~1.3579	KRUZ 1.3386 SLK				IDFK 1-11/32"(34.13mm)	IDPK 1-11/32"(34.13mm)	KRUZ 340 L3=50 SLK			
1.3583~1.3776	KRUZ 1.3583 SLK				IDFK 1-3/8"(34.93mm)	IDPK 1-3/8"(34.93mm)	KRUZ 345 L3=50 SLK			

See to alternative metric body on right if it is suitable to fit in tool holder.

If requires inch holder to convert with metric drill body, see proper inch RSL(reduction sleeve) with metric size.

Indexable, Coolant Drill Series

Indexable, Coolant Drill Series



# **KRUZ-FSLK Flanged body (5xD), IDFK & IDPK insert**



**KRUZ-FSLK**

**IDFK** for beam, angle, single plate

**IDPK** for stacked plate

- ▶ When requires longer drill length, select this ideal drill body
- ▶ Drilling closer to flange part
- ▶ Minimized flute design with longer cylindrical neck
- ▶ Increased drill's rigidity than ordinary 5xDia drill length
- ▶ Internal coolant fed design
- ▶ Flanged shank to reduce chattering or vibrating

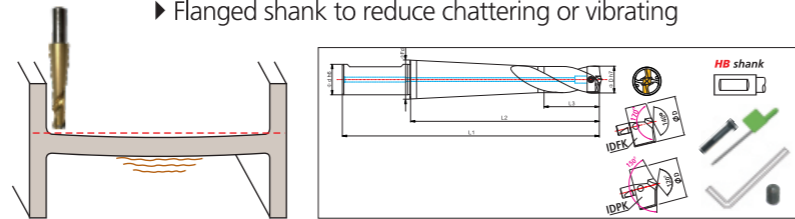

## Exclusively designed for Structural machining

Hole (Φ) mm	Body Code	Shank Ød (L)	Dimension			Flanged dia.(ΦFd)	Insert IDFK	Insert IDPK	Cap Screw	Torx driver	Set Screw	L-wrench
			L1	L2	L3							
12.0~12.4	KRUZ 120P FL50 FSLK	16 (48)	133	85	21	IDFK 120, IDFK 121, IDFK 122, IDFK 123, IDFK 124 IDPK 120, IDPK 121, IDPK 122, IDPK 123, IDPK 124	IDFK 125, IDFK 126, IDFK 127, IDFK 128, IDFK 129 IDPK 125, IDPK 126, IDPK 127, IDPK 128, IDPK 129	CS 120 -135 SL	T6 Torque 0.6Nm (Max)			
12.5~12.9	KRUZ 125P FL50 FSLK		136	88								
13.0~13.4	KRUZ 130P FL50 FSLK		140	92								
13.5~13.9	KRUZ 135P FL50 FSLK		143	95								
14.0~14.4	KRUZ 140P FL50 FSLK	20 (50)	147	99	27	IDFK 130, IDFK 131, IDFK 132, IDFK 133, IDFK 134 IDPK 130, IDPK 131, IDPK 132, IDPK 133, IDPK 134	IDFK 135, IDFK 136, IDFK 137, IDFK 138, IDFK 139 IDPK 135, IDPK 136, IDPK 137, IDPK 138, IDPK 139	CS 140 -155 SL	T7 Torque 0.9Nm (Max)	M2.5x4	1.3mm	
14.5~14.9	KRUZ 145P FL50 FSLK		150	102								
15.0~15.4	KRUZ 150P FL50 FSLK		157	107								
15.5~15.9	KRUZ 155P FL50 FSLK		161	111								
16.0~16.4	KRUZ 160P FL50 FSLK	25 (56)	164	114	32	IDFK 140, IDFK 141, IDFK 142, IDFK 143, IDFK 144 IDPK 140, IDPK 141, IDPK 142, IDPK 143, IDPK 144	IDFK 145, IDFK 146, IDFK 147, IDFK 148, IDFK 149 IDPK 145, IDPK 146, IDPK 147, IDPK 148, IDPK 149	CS 160 -175 SL	T8 Torque 1.5Nm (Max)	M3x6	1.5mm	
16.5~16.9	KRUZ 165P FL50 FSLK		168	118								
17.0~17.4	KRUZ 170P FL50 FSLK		171	121								
17.5~17.9	KRUZ 175P FL50 FSLK		174	124								
18.0~18.4	KRUZ 180P FL50 FSLK	32 (60)	178	128	39	IDFK 170, IDFK 171, IDFK 172, IDFK 173, IDFK 174 IDPK 170, IDPK 171, IDPK 172, IDPK 173, IDPK 174	IDFK 175, IDFK 176, IDFK 177, IDFK 178, IDFK 179 IDPK 175, IDPK 176, IDPK 177, IDPK 178, IDPK 179	CS 180 -195 SL	T115 Torque 3.5Nm (Max)	M4x8	2.0mm	
18.5~18.9	KRUZ 185P FL50 FSLK		181	131								
19.0~19.4	KRUZ 190P FL50 FSLK		185	135								
19.5~19.9	KRUZ 195P FL50 FSLK		188	138								
20.0~20.4	KRUZ 200P FL50 FSLK	32 (60)	197	141	39	IDFK 180, IDFK 181, IDFK 182, IDFK 183, IDFK 184 IDPK 180, IDPK 181, IDPK 182, IDPK 183, IDPK 184	IDFK 185, IDFK 186, IDFK 187, IDFK 188, IDFK 189 IDPK 185, IDPK 186, IDPK 187, IDPK 188, IDPK 189	CS 200 -215 SL				
20.5~20.9	KRUZ 205P FL50 FSLK		201	145								
21.0~21.4	KRUZ 210P FL50 FSLK		204	148								
21.5~21.9	KRUZ 215P FL50 FSLK		208	152								
22.0~22.4	KRUZ 220P FL50 FSLK	32 (60)	211	155	39	IDFK 200, IDFK 201, IDFK 202, IDFK 203, IDFK 204 IDPK 200, IDPK 201, IDPK 202, IDPK 203, IDPK 204	IDFK 205, IDFK 206, IDFK 207, IDFK 208, IDFK 209 IDPK 205, IDPK 206, IDPK 207, IDPK 208, IDPK 209	CS 220 -235 SL				
22.5~22.9	KRUZ 225P FL50 FSLK		214	158								
23.0~23.4	KRUZ 230P FL50 FSLK		218	162								
23.5~23.9	KRUZ 235P FL50 FSLK		221	165								
24.0~24.4	KRUZ 240P FL50 FSLK	32 (60)	229	169	39	IDFK 210, IDFK 211, IDFK 212, IDFK 213, IDFK 214 IDPK 210, IDPK 211, IDPK 212, IDPK 213, IDPK 214	IDFK 215, IDFK 216, IDFK 217, IDFK 218, IDFK 219 IDPK 215, IDPK 216, IDPK 217, IDPK 218, IDPK 219	CS 240 -255 SL				
24.5~24.9	KRUZ 245P FL50 FSLK		232	172								
25.0~25.4	KRUZ 250P FL50 FSLK		235	175								
25.5~25.9	KRUZ 255P FL50 FSLK		239	179								
26.0~26.4	KRUZ 260P FL50 FSLK	32 (60)	242	182	39	IDFK 220, IDFK 221, IDFK 222, IDFK 223, IDFK 224 IDPK 220, IDPK 221, IDPK 222, IDPK 223, IDPK 224	IDFK 225, IDFK 226, IDFK 227, IDFK 228, IDFK 229 IDPK 225, IDPK 226, IDPK 227, IDPK 228, IDPK 229	CS 260 -275 SL				
26.5~26.9	KRUZ 265P FL50 FSLK		246	186								
27.0~27.4	KRUZ 270P FL50 FSLK		249	189								
27.5~27.9	KRUZ 275P FL50 FSLK		252	192								
28.0~28.4	KRUZ 280P FL50 FSLK	32 (60)	256	196	39	IDFK 230, IDFK 231, IDFK 232, IDFK 233, IDFK 234 IDPK 230, IDPK 231, IDPK 232, IDPK 233, IDPK 234	IDFK 235, IDFK 236, IDFK 237, IDFK 238, IDFK 239 IDPK 235, IDPK 236, IDPK 237, IDPK 238, IDPK 239	CS 280 -295 SL				
28.5~28.9	KRUZ 285P FL50 FSLK		259	199								
29.0~29.4	KRUZ 290P FL50 FSLK		263	203								
29.5~29.9	KRUZ 295P FL50 FSLK		266	206								

## Exclusively designed for Structural machining

Hole (Φ) mm	Body Code	Shank Ød (L)	Dimension			Flanged dia.(ΦFd)	Insert IDFK	Insert IDPK	Cap Screw	Torx driver	Set Screw	L-wrench
			L1	L2	L3							
30.0~30.4	KRUZ 300P FL70 FSLK	32 (60)	269	209	70	39	IDFK 300, IDFK 301, IDFK 302, IDFK 303, IDFK 304 IDPK 300, IDPK 301, IDPK 302, IDPK 303, IDPK 304	IDFK 305, IDFK 306, IDFK 307, IDFK 308, IDFK 309 IDPK 305, IDPK 306, IDPK 307, IDPK 308, IDPK 309	CS 300 -315 SL		M4x8	2.0mm
30.5~30.9	KRUZ 305P FL70 FSLK		273	213								
31.0~31.4	KRUZ 310P FL70 FSLK		276	216								
31.5~31.9	KRUZ 315P FL70 FSLK		280	220								
32.0~32.4	KRUZ 320P FL70 FSLK	32 (60)	283	223	70	39	IDFK 310, IDFK 311, IDFK 312, IDFK 313, IDFK 314 IDPK 310, IDPK 311, IDPK 312, IDPK 313, IDPK 314	IDFK 315, IDFK 316, IDFK 317, IDFK 318, IDFK 319 IDPK 315, IDPK 316, IDPK 317, IDPK 318, IDPK 319	CS 320 -355 SL			
32.5~32.9	KRUZ 325P FL70 FSLK		286	226								
33.0~33.4	KRUZ 330P FL70 FSLK		290	230								
33.5~33.9	KRUZ 335P FL70 FSLK		293	233								
34.0~34.4	KRUZ 340P FL80 FSLK	40 (70)	307	237	80	54	IDFK 320, IDFK 321, IDFK 322, IDFK 323, IDFK 324 IDPK 320, IDPK 321, IDPK 322, IDPK 323, IDPK 324	IDFK 325, IDFK 326, IDFK 327, IDFK 328, IDFK 329 IDPK 325, IDPK 326, IDPK 327, IDPK 328, IDPK 329	CS 360 -395 SL			
34.5~34.9	KRUZ 345P FL80 FSLK		310	240								
35.0~35.4	KRUZ 350P FL80 FSLK		313	243								
35.5~35.9	KRUZ 355P FL80 FSLK		317	247								
36.0~36.4	KRUZ 360P FL80 FSLK	40 (70)	320	250	80	54	IDFK 330, IDFK 331, IDFK 332, IDFK 333, IDFK 334 IDPK 330, IDPK 331, IDPK 332, IDPK 333, IDPK 334	IDFK 335, IDFK 336, IDFK 337, IDFK 338, IDFK 339 IDPK 335, IDPK 336, IDPK 337, IDPK 338, IDPK 339	CS 360 -395 SL			
36.5~36.9	KRUZ 365P FL80 FSLK		324	254								
37.0~37.4	KRUZ 370P FL80 FSLK		327	257								
37.5~37.9	KRUZ 375P FL80 FSLK		330	260								
38.0~38.4	KRUZ 380P FL80 FSLK	40 (70)	334	264	80	54	IDFK 340, IDFK 341, IDFK 342, IDFK 343, IDFK 344 IDPK 340, IDPK 341, IDPK 342, IDPK 343, IDPK 344	IDFK 345, IDFK 346, IDFK 347, IDFK 348, IDFK 349 IDPK 345, IDPK 346, IDPK 347, IDPK 348, IDPK 349	CS 360 -395 SL			
38.5~38.9	KRUZ 385P FL80 FSLK		337	267								
39.0~39.4	KRUZ 390P FL80 FSLK		341	271								
39.5~39.9	KRUZ 395P FL80 FSLK		344	274								
40.0~40.4	KRUZ 400P FL80 FSLK	40 (70)	347	277	80	54	IDFK 350, IDFK 351, IDFK 352, IDFK 353, IDFK 354 IDPK 350, IDPK 351, IDPK 352, IDPK 353, IDPK 354	IDFK 355, IDFK 356, IDFK 357, IDFK 358, IDFK 359 IDPK 355, IDPK 356, IDPK 357, IDPK 358, IDPK 359	CS 400 -445 SL			
40.5~40.9	KRUZ 405P FL80 FSLK		351	281								
41.0~41.4	KRUZ 410P FL80 FSLK		354	284								
41.5~41.9	KRUZ 415P FL80 FSLK		358	288								
42.0~42.4	KRUZ 420P FL80 FSLK	40 (70)	361	291	80	54	IDFK 360, IDFK 361, IDFK 362, IDFK 363, IDFK 364 IDPK 360, IDPK 361, IDPK 362, IDPK 363, IDPK 364	IDFK 365, IDFK 366, IDFK 367, IDFK 368, IDFK 369 IDPK 365, IDPK 366, IDPK 367, IDPK 368, IDPK 369	CS 400 -445 SL			
42.5~42.9	KRUZ 425P FL80 FSLK		364	294								
43.0~43.4	KRUZ 430P FL80 FSLK		368	298								
43.5~43.9	KRUZ 435P FL80 FSLK		371	301								
44.0~44.4	KRUZ 440P FL80 FSLK	40 (70)	375	305	80	54	IDFK 370, IDFK 371, IDFK 372, IDFK 373, IDFK 374 IDPK 370, IDPK 371, IDPK 372, IDPK 373, IDPK 374	IDFK 375, IDFK 376, IDFK 377, IDFK 378, IDFK 379 IDPK 375, IDPK 376, IDPK 377, IDPK 378, IDPK 379	CS 450 -500 SL			
44.5~44.9	KRUZ 445P FL80 FSLK		378	308								
45.0~45.4	KRUZ 450P FL80 FSLK		381	311								
45.5~45.9	KRUZ 455P FL80 FSLK		385	315								
46.0~46.4	KRUZ 460P FL80 FSLK	40 (70)	388	318	80	54	IDFK 380, IDFK 381, IDFK 382, IDFK 383, IDFK 384 IDPK 380, IDPK 381, IDPK 382, IDPK 383, IDPK 384	IDFK 385, IDFK 386, IDFK 387, IDFK 388, IDFK 389 IDPK 385, IDPK 386, IDPK 387, IDPK 388, IDPK 389	CS 450 -500 SL			
46.5~46.9	KRUZ 465P FL80 FSLK		392	322								
47.0~47.4	KRUZ 470P FL80 FSLK		395	325								
47.5~47.9	KRUZ 475P FL80 FSLK		398	328								
48.0~48.4	KRUZ 480P FL90 FSLK	40 (70)	402	332	80	54	IDFK 390, IDFK 391, IDFK 392, IDFK 393, IDFK 394 IDPK 390, IDPK 391, IDPK 392, IDPK 393, IDPK 394	IDFK 395, IDFK 396, IDFK 397, IDFK 398, IDFK 399 IDPK 395, IDPK 396, IDPK 397, IDPK 398, IDPK 399	CS 450 -500 SL			
48.5~48.9	KRUZ 485P FL90 FSLK		405	335								
49.0~49.4	KRUZ 490P FL90 FSLK		409	339								
49.5~49.9	KRUZ 495P FL90 FSLK		412	342								
50.0~50.4	KRUZ 500P FL90 FSLK	415	345	90		IDFK 400, IDFK 401, IDFK 402, IDFK 403, IDFK 404 IDPK 400, IDPK 401, IDPK 402, IDPK 403, IDPK 404	IDFK 405, IDFK 406, IDFK 407, IDFK 408, IDFK 409 IDPK 405, IDPK 406, IDPK 407, IDPK 408, IDPK 409					

Size not shown on above is available upon request.



# KRUZ-FSLK Flanged body (7xD), IDFK & IDPK insert



**KRUZ-FSLK**

**IDFK** for beam, angle, single plate

**IDPK** for stacked plate

- ▶ When requires longer drill length, select this ideal drill body
- ▶ Drilling closer to flange part
- ▶ Minimized flute design with longer cylindrical neck
- ▶ Increased drill's rigidity than ordinary 7xDia drill length
- ▶ Internal coolant fed design
- ▶ Flanged shank to reduce chattering or vibrating

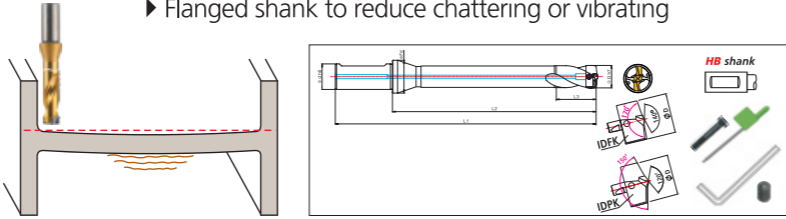

## Exclusively designed for Structural machining

Hole (Φ) mm	Body Code	Shank Ød (L)	Dimension			Flanged dia.(ΦFd)	Insert IDFK	Insert IDPK	Cap Screw	Torx driver	Set Screw	L-wrench
			L1	L2	L3							
12.0~12.4	KRUZ 120H FL50 FSLK	16 (48)	157	109	21	21	IDFK 120, IDFK 121, IDFK 122, IDFK 123, IDFK 124 IDPK 120, IDPK 121, IDPK 122, IDPK 123, IDPK 124	CS 120 -135 SL	T6 Torque 0.6Nm (Max)			
12.5~12.9	KRUZ 125H FL50 FSLK		161	113			IDFK 125, IDFK 126, IDFK 127, IDFK 128, IDFK 129 IDPK 125, IDPK 126, IDPK 127, IDPK 128, IDPK 129					
13.0~13.4	KRUZ 130H FL50 FSLK		166	118			IDFK 130, IDFK 131, IDFK 132, IDFK 133, IDFK 134 IDPK 130, IDPK 131, IDPK 132, IDPK 133, IDPK 134					
13.5~13.9	KRUZ 135H FL50 FSLK		170	122			IDFK 135, IDFK 136, IDFK 137, IDFK 138, IDFK 139 IDPK 135, IDPK 136, IDPK 137, IDPK 138, IDPK 139					
14.0~14.4	KRUZ 140H FL50 FSLK	20 (50)	175	127	27	27	IDFK 140, IDFK 141, IDFK 142, IDFK 143, IDFK 144 IDPK 140, IDPK 141, IDPK 142, IDPK 143, IDPK 144	CS 140 -155 SL	T7 Torque 0.9Nm (Max)	M2.5x4	1.3mm	
14.5~14.9	KRUZ 145H FL50 FSLK		181	131			IDFK 145, IDFK 146, IDFK 147, IDFK 148, IDFK 149 IDPK 145, IDPK 146, IDPK 147, IDPK 148, IDPK 149					
15.0~15.4	KRUZ 150H FL50 FSLK		187	137			IDFK 150, IDFK 151, IDFK 152, IDFK 153, IDFK 154 IDPK 150, IDPK 151, IDPK 152, IDPK 153, IDPK 154					
15.5~15.9	KRUZ 155H FL50 FSLK		192	142			IDFK 155, IDFK 156, IDFK 157, IDFK 158, IDFK 159 IDPK 155, IDPK 156, IDPK 157, IDPK 158, IDPK 159					
16.0~16.4	KRUZ 160H FL50 FSLK	25 (56)	196	146	32	32	IDFK 160, IDFK 161, IDFK 162, IDFK 163, IDFK 164 IDPK 160, IDPK 161, IDPK 162, IDPK 163, IDPK 164	CS 160 -175 SL	T8 Torque 1.5Nm (Max)	M3x6	1.5mm	
16.5~16.9	KRUZ 165H FL50 FSLK		201	151			IDFK 165, IDFK 166, IDFK 167, IDFK 168, IDFK 169 IDPK 165, IDPK 166, IDPK 167, IDPK 168, IDPK 169					
17.0~17.4	KRUZ 170H FL50 FSLK		205	155			IDFK 170, IDFK 171, IDFK 172, IDFK 173, IDFK 174 IDPK 170, IDPK 171, IDPK 172, IDPK 173, IDPK 174					
17.5~17.9	KRUZ 175H FL50 FSLK		209	159			IDFK 175, IDFK 176, IDFK 177, IDFK 178, IDFK 179 IDPK 175, IDPK 176, IDPK 177, IDPK 178, IDPK 179					
18.0~18.4	KRUZ 180H FL50 FSLK	32 (60)	214	164	39	39	IDFK 180, IDFK 181, IDFK 182, IDFK 183, IDFK 184 IDPK 180, IDPK 181, IDPK 182, IDPK 183, IDPK 184	CS 180 -195 SL	T15 Torque 3.5Nm (Max)	M4x8	2.0mm	
18.5~18.9	KRUZ 185H FL50 FSLK		218	168			IDFK 185, IDFK 186, IDFK 187, IDFK 188, IDFK 189 IDPK 185, IDPK 186, IDPK 187, IDPK 188, IDPK 189					
19.0~19.4	KRUZ 190H FL50 FSLK		223	173			IDFK 190, IDFK 191, IDFK 192, IDFK 193, IDFK 194 IDPK 190, IDPK 191, IDPK 192, IDPK 193, IDPK 194					
19.5~19.9	KRUZ 195H FL50 FSLK		227	177			IDFK 195, IDFK 196, IDFK 197, IDFK 198, IDFK 199 IDPK 195, IDPK 196, IDPK 197, IDPK 198, IDPK 199					
20.0~20.4	KRUZ 200H FL50 FSLK	32 (60)	237	181	39	39	IDFK 200, IDFK 201, IDFK 202, IDFK 203, IDFK 204 IDPK 200, IDPK 201, IDPK 202, IDPK 203, IDPK 204	CS 200 -215 SL	T8 Torque 1.5Nm (Max)	M3x6	1.5mm	
20.5~20.9	KRUZ 205H FL50 FSLK		242	186			IDFK 205, IDFK 206, IDFK 207, IDFK 208, IDFK 209 IDPK 205, IDPK 206, IDPK 207, IDPK 208, IDPK 209					
21.0~21.4	KRUZ 210H FL50 FSLK		246	190			IDFK 210, IDFK 211, IDFK 212, IDFK 213, IDFK 214 IDPK 210, IDPK 211, IDPK 212, IDPK 213, IDPK 214					
21.5~21.9	KRUZ 215H FL50 FSLK		251	195			IDFK 215, IDFK 216, IDFK 217, IDFK 218, IDFK 219 IDPK 215, IDPK 216, IDPK 217, IDPK 218, IDPK 219					
22.0~22.4	KRUZ 220H FL50 FSLK	32 (60)	255	199	39	39	IDFK 220, IDFK 221, IDFK 222, IDFK 223, IDFK 224 IDPK 220, IDPK 221, IDPK 222, IDPK 223, IDPK 224	CS 220 -235 SL	T15 Torque 3.5Nm (Max)	M4x8	2.0mm	
22.5~22.9	KRUZ 225H FL50 FSLK		259	203			IDFK 225, IDFK 226, IDFK 227, IDFK 228, IDFK 229 IDPK 225, IDPK 226, IDPK 227, IDPK 228, IDPK 229					
23.0~23.4	KRUZ 230H FL50 FSLK		264	208			IDFK 230, IDFK 231, IDFK 232, IDFK 233, IDFK 234 IDPK 230, IDPK 231, IDPK 232, IDPK 233, IDPK 234					
23.5~23.9	KRUZ 235H FL50 FSLK		268	212			IDFK 235, IDFK 236, IDFK 237, IDFK 238, IDFK 239 IDPK 235, IDPK 236, IDPK 237, IDPK 238, IDPK 239					
24.0~24.4	KRUZ 240H FL50 FSLK	32 (60)	277	217	39	39	IDFK 240, IDFK 241, IDFK 242, IDFK 243, IDFK 244 IDPK 240, IDPK 241, IDPK 242, IDPK 243, IDPK 244	CS 240 -255 SL	T15 Torque 3.5Nm (Max)	M4x8	2.0mm	
24.5~24.9	KRUZ 245H FL50 FSLK		281	221			IDFK 245, IDFK 246, IDFK 247, IDFK 248, IDFK 249 IDPK 245, IDPK 246, IDPK 247, IDPK 248, IDPK 249					
25.0~25.4	KRUZ 250H FL50 FSLK		285	225			IDFK 250, IDFK 251, IDFK 252, IDFK 253, IDFK 254 IDPK 250, IDPK 251, IDPK 252, IDPK 253, IDPK 254					
25.5~25.9	KRUZ 255H FL50 FSLK		290	230			IDFK 255, IDFK 256, IDFK 257, IDFK 258, IDFK 259 IDPK 255, IDPK 256, IDPK 257, IDPK 258, IDPK 259					
26.0~26.4	KRUZ 260H FL50 FSLK	32 (60)	294	234	39	39	IDFK 260, IDFK 261, IDFK 262, IDFK 263, IDFK 264 IDPK 260, IDPK 261, IDPK 262, IDPK 263, IDPK 264	CS 260 -275 SL	T15 Torque 3.5Nm (Max)	M4x8	2.0mm	
26.5~26.9	KRUZ 265H FL50 FSLK		299	239			IDFK 265, IDFK 266, IDFK 267, IDFK 268, IDFK 269 IDPK 265, IDPK 266, IDPK 267, IDPK 268, IDPK 269					
27.0~27.4	KRUZ 270H FL50 FSLK		303	243			IDFK 270, IDFK 271, IDFK 272, IDFK 273, IDFK 274 IDPK 270, IDPK 271, IDPK 272, IDPK 273, IDPK 274					
27.5~27.9	KRUZ 275H FL50 FSLK		307	247			IDFK 275, IDFK 276, IDFK 277, IDFK 278, IDFK 279 IDPK 275, IDPK 276, IDPK 277, IDPK 278, IDPK 279					
28.0~28.4	KRUZ 280H FL50 FSLK	32 (60)	312	252	39	39	IDFK 280, IDFK 281, IDFK 282, IDFK 283, IDFK 284 IDPK 280, IDPK 281, IDPK 282, IDPK 283, IDPK 284	CS 280 -295 SL	T15 Torque 3.5Nm (Max)	M4x8	2.0mm	
28.5~28.9	KRUZ 285H FL50 FSLK		316	256			IDFK 285, IDFK 286, IDFK 287, IDFK 288, IDFK 289 IDPK 285, IDPK 286, IDPK 287, IDPK 288, IDPK 289					
29.0~29.4	KRUZ 290H FL50 FSLK		321	261			IDFK 290, IDFK 291, IDFK 292, IDFK 293, IDFK 294 IDPK 290, IDPK 291, IDPK 292, IDPK 293, IDPK 294					
29.5~29.9	KRUZ 295H FL50 FSLK		325	265			IDFK 295, IDFK 296, IDFK 297, IDFK 298, IDFK 299 IDPK 295, IDPK 296, IDPK 297, IDPK 298, IDPK 299					

## Exclusively designed for Structural machining

Hole (Φ) mm	Body Code	Shank Ød (L)	Dimension			Flanged dia.(ΦFd)	Insert IDFK	Insert IDPK	Cap Screw	Torx driver	Set Screw	L-wrench
			L1	L2	L3							
30.0~30.4	KRUZ 300H FL70 FSLK	32 (60)	329	269	70	70	IDFK 300, IDFK 301, IDFK 302, IDFK 303, IDFK 304 IDPK 300, IDPK 301, IDPK 302, IDPK 303, IDPK 304	CS 300 -315 SL	T6 Torque 0.6Nm (Max)		M4x8 2.0mm	
30.5~30.9	KRUZ 305H FL70 FSLK		334	274			IDFK 305, IDFK 306, IDFK 307, IDFK 308, IDFK 309 IDPK 305, IDPK 306, IDPK 307, IDPK 308, IDPK 309					
31.0~31.4	KRUZ 310H FL70 FSLK		338	278			IDFK 310, IDFK 311, IDFK 312, IDFK 313, IDFK 314 IDPK 310, IDPK 311, IDPK 312, IDPK 313, IDPK 314					
31.5~31.9	KRUZ 315H FL70 FSLK		343	283			IDFK 315, IDFK 316, IDFK 317, IDFK 318, IDFK 319 IDPK 315, IDPK 316, IDPK 317, IDPK 318, IDPK 319					
32.0~32.4	KRUZ 320H FL70 FSLK	32 (60)	347	287	70	70	IDFK 320, IDFK 321, IDFK 322, IDFK 323, IDFK 324 IDPK 320, IDPK 321, IDPK 322, IDPK 323, IDPK 324	CS 320 -355 SL	T6 Torque 0.6Nm (Max)		M4x8 2.0mm	
32.5~32.9	KRUZ 325H FL70 FSLK		351	291			IDFK 325, IDFK 326, IDFK 327, IDFK 328, IDFK 329 IDPK 325, IDPK 326, IDPK 327, IDPK 328, IDPK 329					
33.0~33.4	KRUZ 330H FL70 FSLK		356	296			IDFK 330, IDFK 331, IDFK 332, IDFK 333, IDFK 334 IDPK 330, IDPK 331, IDPK 332, IDPK 333, IDPK 334					
33.5~33.9	KRUZ 335H FL70 FSLK		360	300			IDFK 335, IDFK 336, IDFK 337, IDFK 338, IDFK 339 IDPK 335, IDPK 336, IDPK 337, IDPK 338, IDPK 339					
34.0~34.4	KRUZ 340H FL80 FSLK	32 (60)	375	305	80	80	IDFK 340, IDFK 341, IDFK 342, IDFK 343, IDFK 344 IDPK 340, IDPK 341, IDPK 342, IDPK 343, IDPK 344	CS 360 -395 SL	T7 Torque 0.9Nm (Max)	M2.5x4	1.3mm	
34.5~34.9	KRUZ 345H FL80 FSLK		379	309			IDFK 345, IDFK 346, IDFK 347, IDFK 348, IDFK 349 IDPK 345, IDPK 346, IDPK 347, IDPK 348, IDPK 349					
35.0~35.4	KRUZ 350H FL80 FSLK		383	313			IDFK 350, IDFK 351, IDFK 352, IDFK 353, IDFK 354 IDPK 350, IDPK 351, IDPK 352, IDPK 353, IDPK 354					
35.5~35.9	KRUZ 355H FL80 FSLK		388	318			IDFK 355, IDFK 356, IDFK 357, IDFK 358, IDFK 359 IDPK 355, IDPK 356, IDPK 357, IDPK 358, IDPK 359					
36.0~36.4	KRUZ 360H FL80 FSLK	32 (60)	392	322	80	80	IDFK 360, IDFK 361, IDFK 362, IDFK 363, IDFK 364 IDPK 360, IDPK 361, IDPK 362, IDPK 363, IDPK 364	CS 360 -395 SL	T7 Torque 0.9Nm (Max)	M2.5x4	1.3mm	
36.5~36.9	KRUZ 365H FL80 FSLK		397	327			IDFK 365, IDFK 366, IDFK 367, IDFK 368, IDFK 369 IDPK 365, IDPK 366, IDPK 367, IDPK 368, IDPK 369					
37.0~37.4	KRUZ 370H FL80 FSLK		401	331			IDFK 370, IDFK 371, IDFK 372, IDFK 373, IDFK 374 IDPK 370, IDPK 371, IDPK 372, IDPK 373, IDPK 374					
37.5~37.9	KRUZ 375H FL80 FSLK		405	335			IDFK 375, IDFK 376, IDFK 377, IDFK 378, IDFK 379 IDPK 375, IDPK 376, IDPK 377, IDPK 378, IDPK 379					
38.0~38.4	KRUZ 380H FL80 FSLK	32 (60)	410	340	80	80	IDFK 380, IDFK 381, IDFK 382, IDFK 383, IDFK 384 IDPK 380, IDPK 381, IDPK 382, IDPK 383, IDPK 384	CS 360 -395 SL	T7 Torque 0.9Nm (Max)	M2.5x4	1.3mm	
38.5~38.9	KRUZ 385H FL80 FSLK		414	344			IDFK 385, IDFK 386, IDFK 387, IDFK 388, IDFK 389 IDPK 385, IDPK 386, IDPK 387, IDPK 388, IDPK 389					
39.0~39.4	KRUZ 390H FL80 FSLK		419	349			IDFK 390, IDFK 391, IDFK 392, IDFK 393, IDFK 394 IDPK 390, IDPK 391, IDPK 392, IDPK 393, IDPK 394					
39.5~39.9	KRUZ 395H FL80 FSLK		423	353			IDFK 395, IDFK 396, IDFK 397, IDFK 398, IDFK 399 IDPK 395, IDPK 396, IDPK 397, IDPK 398, IDPK 399					
40.0~40.4	KRUZ 400H FL80 FSLK	32 (60)	427	357	80	80	IDFK 400, IDFK 401, IDFK 402, IDFK 403, IDFK 404 IDPK 400, IDPK 401, IDPK 402, IDPK 403, IDPK 404	CS 400 -445 SL	T8 Torque 1.5Nm (Max)	M3x6	1.5mm	
40.5~40.9	KRUZ 405H FL80 FSLK		432	362			IDFK 405, IDFK 406, IDFK 407, IDFK 408, IDFK 409 IDPK 405, IDPK 406, IDPK 407, IDPK 408, IDPK 409					
41.0~41.4	KRUZ 410H FL80 FSLK		436	366			IDFK 410, IDFK 411, IDFK 412, IDFK 413, IDFK 414 IDPK 410, IDPK 411, IDPK 412, IDPK 413, IDPK 414					
41.5~41.9	KRUZ 415H FL80 FSLK		441	371			IDFK 415, IDFK 416, IDFK 417, IDFK 418, IDFK 419 IDPK 415, IDPK 416, IDPK 417, IDPK 418, IDPK 419					
42.0~42.4	KRUZ 420H FL80 FSLK	32 (60)	445	375	80	80	IDFK 420, IDFK 421, IDFK 422, IDFK 423, IDFK 424 IDPK 420, IDPK 421, IDPK 422, IDPK 423, IDPK 424	CS 400 -445 SL	T8 Torque 1.5Nm (Max)	M3x6	1.5mm	
42.5~42.9	KRUZ 425H FL80 FSLK		449	379			IDFK 425, IDFK 426, IDFK 427, IDFK 428, IDFK 429 IDPK 425, IDPK 426, IDPK 427, IDPK 428, IDPK 429					
43.0~43.4	KRUZ 430H FL80 FSLK		454	384			IDFK 430, IDFK 431, IDFK 432, IDFK 433, IDFK 434 IDPK 430, IDPK 431, IDPK 432, IDPK 433, IDPK 434					
43.5~43.9	KRUZ 435H FL80 FSLK		458	388			IDFK 435, IDFK 436, IDFK 437, IDFK 438, IDFK 439 IDPK 435, IDPK 436, IDPK 437, IDPK 438, IDPK 439					
44.0~44.4	KRUZ 440H FL80 FSLK	32 (60)	463	393	80	80	IDFK 440, IDFK 441, IDFK 442, IDFK 443, IDFK 444 IDPK 440, IDPK 441, IDPK 442, IDPK 443, IDPK 444	CS 450 -500 SL	T15 Torque 3.5Nm (Max)	M4x8	2.0mm	
44.5~44.9	KRUZ 445H FL80 FSLK		467	397			IDFK 445, IDFK 446, IDFK 447, IDFK 448, IDFK 449 IDPK 445, IDPK 446, IDPK 447, IDPK 448, IDPK 449					
45.0~45.4	KRUZ 450H FL80 FSLK		471	401			IDFK 450, IDFK 451, IDFK 452, IDFK 453, IDFK 454 IDPK 450, IDPK 451, IDPK 452, IDPK 453, IDPK 454					
45.5~45.9	KRUZ 455H FL80 FSLK		476	406			IDFK 455, IDFK 456, IDFK 457, IDFK 458, IDFK 459 IDPK 455, IDPK 456, IDPK 457, IDPK 458, IDPK 459					
46.0~46.4	KRUZ 460H FL80 FSLK	32 (60)	480	410	80	80	IDFK 460, IDFK 461, IDFK 462, IDFK 463, IDFK 464 IDPK 460, IDPK 461, IDPK 462, IDPK 463, IDPK 464	CS 450 -500 SL	T15 Torque 3.5Nm (Max)	M4x8	2.0mm	
46.5~46.9	KRUZ 465H FL80 FSLK		485	415			IDFK 465, IDFK 466, IDFK 467, IDFK 468, IDFK 469 IDPK 465, IDPK 466, IDPK 467, IDPK 468, IDPK 469					
47.0~47.4	KRUZ 470H FL80 FSLK		489	419			IDFK 470, IDFK 471, IDFK 472, IDFK 473,					

# Drilling & Milling tool

## DMH

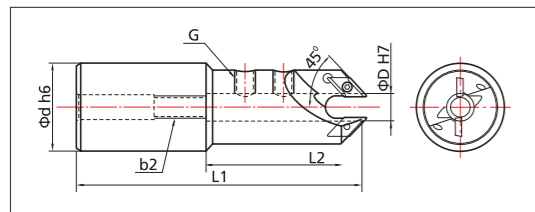

- ▶ Interchangeable carbide drillmill & XCGX insert mounted in the holder
- ▶ Specially designed carbide drillmill(TiAlN) with milling functioned flute
- ▶ Carbide chamfer insert XCGX 1102 with two corner edges
- ▶ Rigid heat-treated tool steel holder with side locking system
- ▶ Drilling, milling and chamfering in one tool economically
- ▶ Added chamfer milling for hole edge

CODE No.	D(mm)	d(mm)	L1	L2	G
DMH 32-8	8	32	110	40	M8
DMH 32-10	10				
DMH 32-12	12				

Other special size is available upon request.  
 Note : Assemble DM drillmill firstly in DMH holder before fasten XCGX inserts.

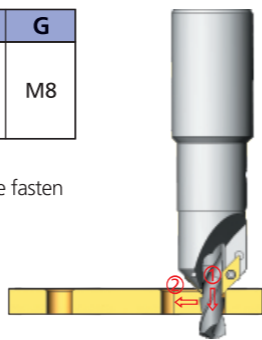

## DM

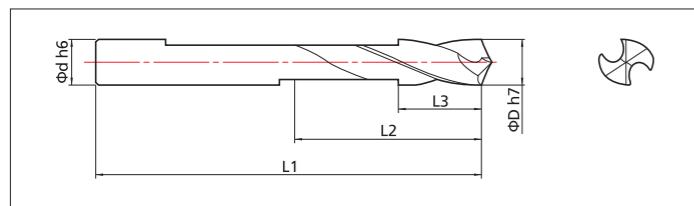

- ▶ Solid carbide material, TiAlN coated
- ▶ YESTOOL's own designed for drilling & milling
- ▶ Flatted grinding to fit two XCGX inserts
- ▶ Used in DMH holder
- ▶ TiAlN coated for longer tool life

CODE No.	D(mm)	d(mm)	L1	L2	L3
DM 080 TiAlN	8.0	8.0	70	30	14.6
DM 100 TiAlN	10.0	10.0			
DM 120 TiAlN	12.0	12.0			

DM drill is to use max. 14mm hole depth. If requires deeper hole, ask us separately stating necessary hole depth

**XCGX**

- ▶ Carbide insert with grinded edges
- ▶ Used two corners economically
- ▶ Hole chamfering application

**XCGX1102**

# MT shank side lock holder

## MT



- ▶ Morse Taper shank holder to fit KRUZ body
- ▶ Side locking system by set screw to fit KRUZ straight shank body
- ▶ Alternative tool for excessively longer HSS MT shank drill
- ▶ Ideal tool in old or unstable machine or chattering work-piece

## MTC

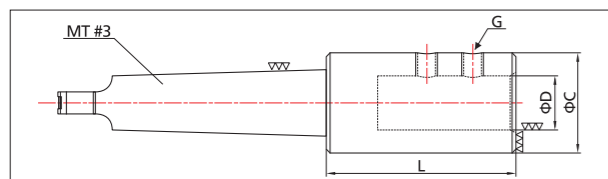

CODE No.	MT#	D(mm)	L(mm)	C(mm)	G
MT3S-SLA16-95	#3	16	95	33	M12
MT3S-SLA20-70		20		37	
MT3S-SLA25-70		25	70	40	
MT3S-SLA32-70		32		48	
MT3S-SLA40-80		40	80	56	

MT#2, MT#4 is available upon request.

# Scribing tool

## STH

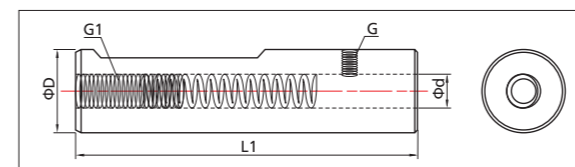

- ▶ Interchangeable carbide scribing drill mounted in the holder
- ▶ Rigid heat-treated tool steel holder
- ▶ Designed with spring system to retract drill for uneven surface.
- ▶ Extra function to use chamfer milling for hole edge

CODE No.	D(mm)	d(mm)	L1	G	G1
STH 080	20	8	83	M4x6	M8x20
STH-Spring	6		40		

## SD

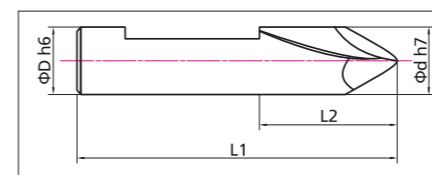

- ▶ TiN coated 90 degree drill point with dual angle for stable scribing
- ▶ Carbide flatted shank drill to fit in STH holder
- ▶ Dual angle point to prevent point chipping
- ▶ Locking by side screws fastening
- ▶ Adjustable tension by threaded screw from holder end

CODE No.	D(mm)	d(mm)	L1	L2
SD 080 TiN	8	8	37	13

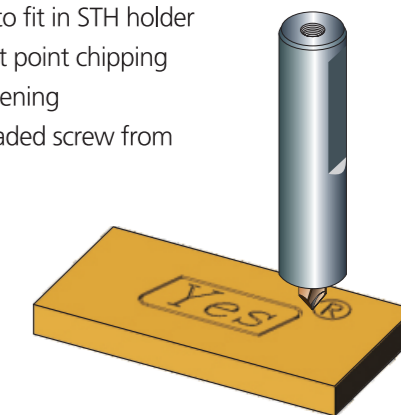

## How to assemble scribing tool

- Push ① SD 080, Scribing tool into tool body until hiding flatted shank completely
- Lock ② Locking screw completely.
- Insert ③ Tension STH-spring inside of tool body
- Turn ④ Adjustment screw right-hand direction and push into the holder-end.
- Finally, loose ② Locking screw by 45° left-hand direction (about 1/8 turn) so that spring's tension can be performed.

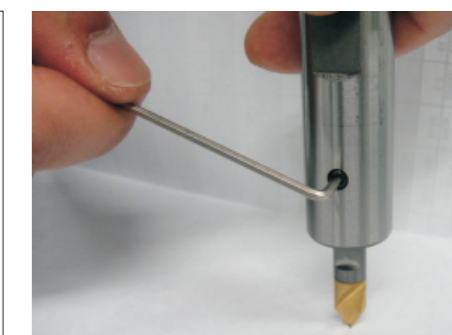
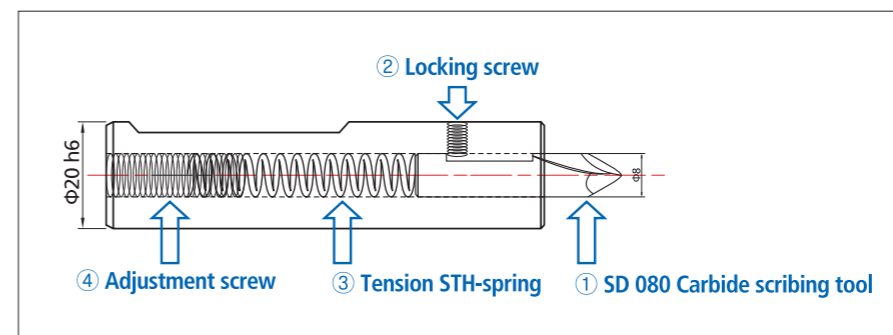

## How to dismantle scribing tool

- Remove ④ Adjustment screw by left-hand direction.
- Take out ③ Tension STH-spring from tool body.
- Loose ② Locking screw.
- Take out ① SD 080 Scribing tool from tool body.

**Warning !** : Be sure to locate scribing drill head lower during disassembly for safety, while tool body-end is upper position (See above photo).



# ISO 45 & HSK Extension holder for Structural



- ▶ ISO 45(HSK) holder can help drilling with strong rigidity
- ▶ Internal coolant channel structure
- ▶ Side locking with two set screws
- ▶ Ideal holder to run KRUZ-SLK body & IDFK insert
- ▶ HSK holder is available upon request

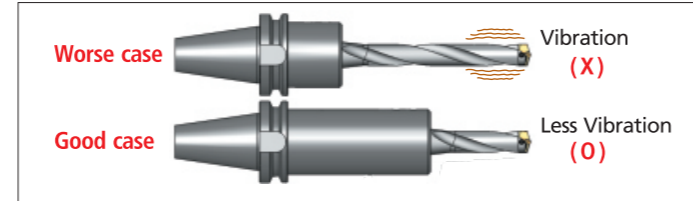
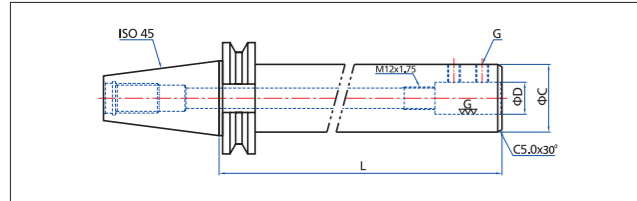

CODE No.	D	L	C	G	CODE No.	D	L	C	G	CODE No.	D	L	C	G
ISO45(HSK)-SLA16-80	16	80	56	M10	ISO45(HSK)-SLA20-400	20	400	56	M12	ISO45(HSK)-SLA32-270	32	270	56	M14
ISO45(HSK)-SLA16-160		160			ISO45(HSK)-SLA20-450		450			ISO45(HSK)-SLA32-300		300		
ISO45(HSK)-SLA16-210		210			ISO45(HSK)-SLA20-500		500			ISO45(HSK)-SLA32-350		350		
ISO45(HSK)-SLA16-240		240			ISO45(HSK)-SLA25-80		80			ISO45(HSK)-SLA32-400		400		
ISO45(HSK)-SLA16-270		270			ISO45(HSK)-SLA25-160		160			ISO45(HSK)-SLA32-450		450		
ISO45(HSK)-SLA16-300		300			ISO45(HSK)-SLA25-210		210			ISO45(HSK)-SLA32-500		500		
ISO45(HSK)-SLA16-350		350			ISO45(HSK)-SLA25-240		240			ISO45(HSK)-SLA40-90		90		
ISO45(HSK)-SLA16-400		400			ISO45(HSK)-SLA25-270		270			ISO45(HSK)-SLA40-160		160		
ISO45(HSK)-SLA16-450		450			ISO45(HSK)-SLA25-300		300			ISO45(HSK)-SLA40-210		210		
ISO45(HSK)-SLA16-500		500			ISO45(HSK)-SLA25-350		350			ISO45(HSK)-SLA40-240		240		
ISO45(HSK)-SLA20-80	20	80	56	M12	ISO45(HSK)-SLA25-400	25	400	56	M14	ISO45(HSK)-SLA40-270	40	270	60	M14
ISO45(HSK)-SLA20-160		160			ISO45(HSK)-SLA25-450		450			ISO45(HSK)-SLA40-300		300		
ISO45(HSK)-SLA20-210		210			ISO45(HSK)-SLA25-500		500			ISO45(HSK)-SLA40-350		350		
ISO45(HSK)-SLA20-240		240			ISO45(HSK)-SLA32-80		80			ISO45(HSK)-SLA40-400		400		
ISO45(HSK)-SLA20-270		270			ISO45(HSK)-SLA32-160		160			ISO45(HSK)-SLA40-450		450		
ISO45(HSK)-SLA20-300		300			ISO45(HSK)-SLA32-210		210			ISO45(HSK)-SLA40-500		500		
ISO45(HSK)-SLA20-350		350			ISO45(HSK)-SLA32-240		240							

\* Pull stud bolt not included in the above holder.  
\* ISO40 holder is available upon request.

# Extension socket



- ▶ When drill length is in short, use extension socket
- ▶ Side lock clamping
- ▶ Holding same drill shank diameter

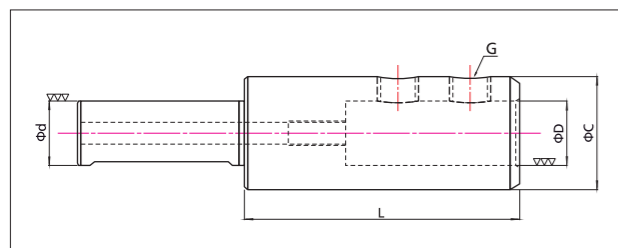

CODE No.	d(mm)	D(mm)	L(mm)	C(mm)	G
EXT16-SLA16-80	16	16	80	50	M10
EXT16-SLA16-125			125		
EXT16-SLA16-150			150		
EXT16-SLA16-200			200		
EXT16-SLA16-250			250		
EXT20-SLA20-80	20	20	80	50	M12
EXT20-SLA20-125			125		
EXT20-SLA20-150			150		
EXT20-SLA20-200			200		
EXT20-SLA20-250			250		
EXT25-SLA25-80	25	25	80	50	M12
EXT25-SLA25-125			125		
EXT25-SLA25-150			150		
EXT25-SLA25-200			200		
EXT25-SLA25-250			250		
EXT32-SLA32-80	32	32	80	50	M14
EXT32-SLA32-125			125		
EXT32-SLA32-150			150		
EXT32-SLA32-200			200		
EXT32-SLA32-250			250		
EXT40-SLA40-80	40	40	80	50	M14
EXT40-SLA40-125			125		
EXT40-SLA40-150			150		
EXT40-SLA40-200			200		
EXT40-SLA40-250			250		

# Reduction sleeve

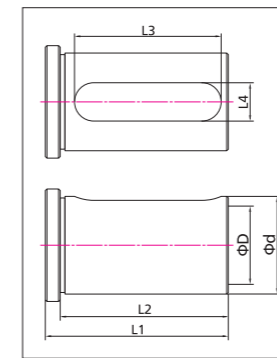

- ▶ RSL designed to use smaller drill shank in bigger holder
- ▶ Fitting KRUZ drill straight shank body easily
- ▶ Both Metric and Inch size available

CODE No.	d(mm)	D(mm)	L1	L2	L3	L4
RSL 32-16	32	16	65	59	50	15
RSL 32-20		20				16
RSL 32-25		25				16
RSL 40-32	40	32	75	69	60	16
RSL 1-1/4"-16	1-1/4"	16	65	59	50	15
RSL 1-1/4"-20		20				16
RSL 1-1/4"-25		25				16
RSL 1-1/2"-32	1-1/2"	32				16

# Technical tip for structural steel machining

Note that structural steel can not be clamped easily due to too big and longer work-piece shape than industrial smaller component parts. When the drilling spindle feed down toward the structural, the part will have a tendency of bending, deformation, chattering or vibrating that is not visible. In order to achieve better drilling, we suggest you to consider following technical points.

- ☞ Don't use excessive longer length to maximize performance. Select a drill as shorter length as it is available to avoid vibrating or chattering trouble.
- ☞ Structural steel is generally less than 50mm thickness only. YESTOOL's KRUZ-SLK drill is properly designed with stubby length enough to run majority of structural steel.
- ☞ In case running with unnecessary longer drill like HSS MT shank length, it will be badly influenced on chattering, vibrating, distorted or oversize hole trouble etc. Of course, tool life could be decreased by above reasons.
- ☞ If you would like to use longer drill inevitably by interruption of flange height, recommend to select KRUZ-FSLK neck extended drill body that is designed to reduce chattering or vibrating trouble than conventional drill.
- ☞ If ISO holder and KRUZ-SLK drill length is insufficient, use Extension socket that can be compensated for shorter length.
- ☞ Reduction sleeve also helps to run current holder without new holder change. This sleeve can be used for reducing shank diameter if inner holder size is bigger than drill shank.
- ☞ The cutting parameter table is shown for recommendation only. Machine operator should find certain optimum value where runs smoothly without vibrating.
- ☞ Plate machining is to apply with different insert. (See the photos on right.)

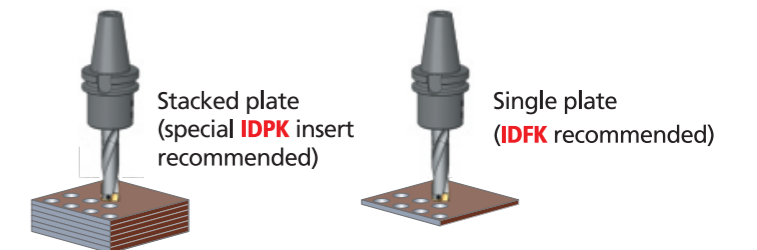

If you are seeking more information, please feel free to contact your local YESTOOL distributor or [yestool@yestool.co.kr](mailto:yestool@yestool.co.kr)

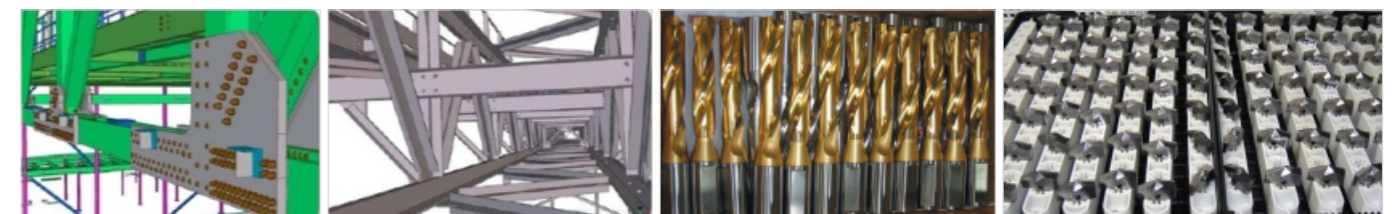



KRUZ SLK body + Carbide IDFK insert

Step	Drill Dia		RPM	Feed rate		Surface speed		Forward speed/min.		Power (KW)	Thrust (KGF)	Stability	Tool life	Speed
	Metric	Inch		f(mm/rev.)	IPR(inch/rev.)	V(m/min.)	SFM(foot/min.)	F(mm)	IPM(inch)					
Step 1	12.0	31/64"	780	0.20	0.008	29	96	156	6.1	1.3	286	stable	longer	slower
	14.0	9/16"	760	0.20	0.008	33	110	152	6.0	1.7	331			
	16.0	41/64"	740	0.21	0.008	37	122	155	6.1	2.2	387			
	17.5	11/16"	720	0.22	0.009	40	130	158	6.2	2.6	434			
	18.0	23/32"	700	0.22	0.009	40	130	154	6.1	2.6	445			
	20.5	13/16"	660	0.23	0.009	42	139	152	6.0	3.2	518			
	21.5	27/32"	620	0.24	0.009	42	137	149	5.9	3.3	556			
	22.0	7/8"	600	0.24	0.009	41	136	144	5.7	3.3	568			
	24.0	15/16"	570	0.26	0.010	43	141	148	5.8	3.9	648			
	26.0	1-1/32"	520	0.28	0.011	42	139	146	5.7	4.2	732			
	27.0	1-1/16"	500	0.28	0.011	42	139	140	5.5	4.3	758			
	30.0	1-3/16"	400	0.29	0.011	38	124	116	4.6	4.1	856			
	32.0	1-1/4"	380	0.29	0.011	38	125	110	4.3	4.3	911			
	34.0	1-11/32"	360	0.29	0.011	38	126	104	4.1	4.5	964			
	36.0	1-27/64"	340	0.29	0.011	38	126	99	3.9	4.7	1018			
	38.0	1-1/2"	320	0.29	0.011	38	125	93	3.7	4.9	1072			
40.0	1-37/64"	300	0.29	0.011	38	124	87	3.4	5.0	1126				
12.0	31/64"	970	0.21	0.008	37	120	204	8.0	1.7	295				
14.0	9/16"	970	0.21	0.008	43	140	204	8.0	2.3	341				
16.0	41/64"	950	0.22	0.009	48	157	209	8.2	3.0	398				
17.5	11/16"	930	0.24	0.009	51	168	223	8.8	3.7	457				
18.0	23/32"	900	0.24	0.009	51	167	216	8.5	3.8	470				
20.5	13/16"	850	0.25	0.010	55	180	213	8.4	4.6	545				
21.5	27/32"	800	0.26	0.010	54	177	208	8.2	4.8	584				
22.0	7/8"	780	0.26	0.010	54	177	203	8.0	4.9	597				
24.0	15/16"	710	0.28	0.011	54	176	199	7.8	5.3	678				
26.0	1-1/32"	640	0.30	0.012	52	171	192	7.6	5.7	763				
27.0	1-1/16"	610	0.30	0.012	52	170	183	7.2	5.8	791				
30.0	1-3/16"	500	0.30	0.012	47	155	150	5.9	5.5	874				
32.0	1-1/4"	470	0.30	0.012	47	155	141	5.6	5.8	930				
34.0	1-11/32"	440	0.31	0.012	47	154	136	5.4	6.1	1005				
36.0	1-27/64"	410	0.31	0.012	46	152	127	5.0	6.2	1061				
38.0	1-1/2"	380	0.31	0.012	45	149	118	4.6	6.3	1116				
40.0	1-37/64"	350	0.31	0.012	44	144	109	4.3	6.3	1172				
12.0	31/64"	1180	0.22	0.009	44	146	260	10.2	2.3	303				
14.0	9/16"	1180	0.22	0.009	52	170	260	10.2	3.1	351				
16.0	41/64"	1160	0.23	0.009	58	191	267	10.5	4.0	409				
17.5	11/16"	1140	0.26	0.010	63	206	296	11.7	5.0	480				
18.0	23/32"	1100	0.26	0.010	62	204	286	11.3	5.1	493				
20.5	13/16"	1040	0.27	0.011	67	220	281	11.1	6.3	571				
21.5	27/32"	980	0.28	0.011	66	217	274	10.8	6.5	611				
22.0	7/8"	960	0.28	0.011	66	218	269	10.6	6.6	624				
24.0	15/16"	850	0.30	0.012	64	210	255	10.0	7.0	707				
26.0	1-1/32"	760	0.32	0.013	62	204	243	9.6	7.4	794				
27.0	1-1/16"	720	0.32	0.013	61	200	230	9.1	7.4	823				
30.0	1-3/16"	600	0.32	0.013	57	185	192	7.6	7.2	909				
32.0	1-1/4"	560	0.32	0.013	56	185	179	7.1	7.5	967				
34.0	1-11/32"	520	0.33	0.013	56	182	172	6.8	7.8	1044				
36.0	1-27/64"	480	0.33	0.013	54	178	158	6.2	7.9	1102				
38.0	1-1/2"	440	0.33	0.013	53	172	145	5.7	7.9	1160				
40.0	1-37/64"	400	0.33	0.013	50	165	132	5.2	7.7	1218				
12.0	31/64"	1330	0.23	0.009	50	164	306	12.0	2.7	311				
14.0	9/16"	1330	0.23	0.009	58	192	306	12.0	3.7	360				
16.0	41/64"	1310	0.24	0.009	66	216	314	12.4	4.8	420				
17.5	11/16"	1290	0.28	0.011	71	233	361	14.2	6.2	502				
18.0	23/32"	1240	0.28	0.011	70	230	347	13.7	6.2	516				
20.5	13/16"	1170	0.29	0.011	75	247	339	13.4	7.6	596				
21.5	27/32"	1100	0.30	0.012	74	244	330	13.0	7.8	637				
22.0	7/8"	1080	0.30	0.012	75	245	324	12.8	8.0	651				
24.0	15/16"	930	0.32	0.013	70	230	298	11.7	8.2	736				
26.0	1-1/32"	850	0.33	0.013	69	228	281	11.0	8.7	809				
27.0	1-1/16"	800	0.33	0.013	68	223	264	10.4	8.6	838				
30.0	1-3/16"	700	0.33	0.013	66	216	231	9.1	8.9	927				
32.0	1-1/4"	650	0.33	0.013	65	214	215	8.4	9.2	985				
34.0	1-11/32"	600	0.34	0.013	64	210	204	8.0	9.6	1063				
36.0	1-27/64"	550	0.34	0.013	62	204	187	7.4	9.6	1122				
38.0	1-1/2"	500	0.34	0.013	60	196	170	6.7	9.4	1181				
40.0	1-37/64"	450	0.34	0.013	57	185	153	6.0	9.1	1240				
12.0	31/64"	1800	0.24	0.009	68	223	432	17.0	4.1	320				
14.0	9/16"	1800	0.24	0.009	79	260	432	17.0	5.6	370				
16.0	41/64"	1780	0.25	0.010	89	293	445	17.5	7.3	431				
17.5	11/16"	1760	0.30	0.012	97	317	528	20.8	9.5	524				
18.0	23/32"	1660	0.30	0.012	94	308	498	19.6	9.3	538				
20.5	13/16"	1580	0.31	0.012	102	334	490	19.3	11.5	621				
21.5	27/32"	1500	0.32	0.013	101	332	480	18.9	12.1	663				
22.0	7/8"	1440	0.32	0.013	99	326	461	18.1	12.0	677				
24.0	15/16"	1250	0.34	0.013	94	309	425	16.7	12.3	763				
26.0	1-1/32"	1120	0.35	0.014	91	300	392	15.4	12.7	838				
27.0	1-1/16"	1020	0.35	0.014	86	284	357	14.1	12.2	869				
30.0	1-3/16"	800	0.35	0.014	75	247	280	11.0	11.0	960				
32.0	1-1/4"	740	0.35	0.014	74	244	259	10.2	11.3	1021				
34.0	1-11/32"	680	0.36	0.014	73	238	245	9.6	11.6	1100				
36.0	1-27/64"	620	0.36	0.014	70	230	223	8.8	11.5	1162				
38.0	1-1/2"	560	0.36	0.014	67	219	202	7.9	11.2	1223				
40.0	1-37/64"	500	0.36	0.014	63	206	180	7.1	10.8	1284				
12.0	31/64"	2040	0.25	0.010	77	252	510	20.1	4.9	328				
14.0	9/16"	2040	0.25	0.010	90	294	510	20.1	6.7	379				
16.0	41/64"	2020	0.26	0.010	101	333	525	20.7	8.8	441				
17.5	11/16"	2000	0.31	0.012	110	361	620	24.4	11.4	535				
18.0	23/32"	1900	0.31	0.012	107	352	589	23.2	11.3	549				
20.5	13/16"	1800	0.32	0.013	116	380	576	22.7	13.9	633				
21.5	27/32"	1700	0.33	0.013	115	377	561	22.1	14.4	675				
22.0	7/8"	1650	0.33	0.013	114	374	545	21.4	14.5	690				
24.0	15/16"	1400	0.35	0.014	106	346	490	19.3	14.5	777				
26.0	1-1/32"	1250	0.36	0.014	102	335	450	17.7	14.9	853				
27.0	1-1/16"	1170	0.36	0.014	99	325	421	16.6	14.7	884				
30.0	1-3/16"	900	0.36	0.014	85	278	324	12.8	13.0	977				
32.0	1-1/4"	830	0.36	0.014	83	274	299	11.8	13.3	1039				
34.0	1-11/32"	760	0.37	0.015	81	266	281	11.1	13.6	1119				
36.0	1-27/64"	680	0.37	0.015	77	252	252	9.9	13.2	1181				
38.0	1-1/2"	610	0.37	0.015	73	239	226	8.9	12.7	1244				
40.0	1-37/64"	550	0.37	0.015	69	227	204	8.0	12.3	1306				

1. Input<Tool Length>before drilling.(Tool length=Holder length+Drill length)  
 2. Input cutting condition from step 1 to step 6 in consideration of productivity or stability.  
 3. Use previous step condition if you find a vibration or unstable result at faster step.  
 4. If you use other size of drill, please ask us about cutting condition via E-mail "yestool@yestool.co.kr"



# ITM multi-4 flutes indexable thread mill

– Economical 4 threading edges



- ▶ Precision ground by YESTOOL's own design technology
- ▶ Strong rigidity to clamp carbide insert in the pocket
- ▶ Internal coolant fed design
- ▶ Internal & external threading available

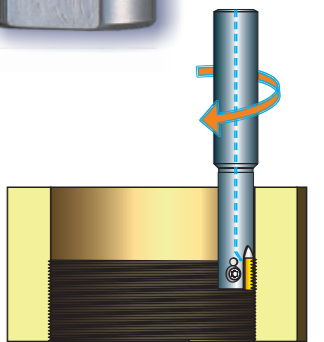
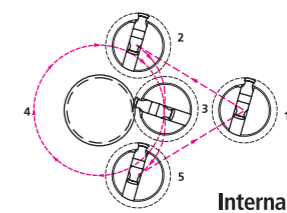

Internal External

Indexable, Coolant Drill Series



# YITM Thread milling holder



**YITM** Thread milling holder

- ▶ Strong tool rigidity to clamp carbide thread mill insert in insert pocket and locking by cap screw
- ▶ Economical 4 thread edges by YESTOOL's own development (except ITM080 which has 2 thread edges)
- ▶ Interchangeable carbide thread milling insert after 4 edge use
- ▶ Internal coolant fed tool body
- ▶ Weldon shank body(HA, HE available on request)

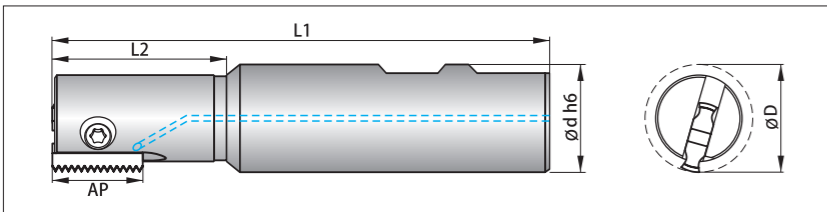

Holder Code	ØD	L1	L2	AP	Shank size Ød	Cap Screw	Torx key	Insert
YITM090	9.0	85	14	12	20	M2.5	T7 Torque 0.9Nm (Max)	ITM080□
YITM095	9.5	85	14	12	20			
YITM100	10.0	85	16	12	20			
YITM115	11.5	88	18	14	20	M3	T8 Torque 1.5Nm (Max)	ITM100□
YITM125	12.5	90	20	14	20			
YITM140	14.0	94	25	14	20			
YITM150	15.0	95	25	16	20			
YITM170	17.0	98	30	16	20	M4	T15 Torque 3.5Nm (Max)	ITM160□
YITM190	19.0	95	30	21	20			
YITM210	21.0	115	40	21	25			
YITM250	25.0	115	40	21	25	M6	T20 Torque 5.0Nm (Max)	ITM220□
YITM285	28.5	140	50	30	25			
YITM310	31.0	140	50	30	25			
YITM380	38.0	160	60	30	32			
YITM420	42.0	170	65	40	40	M8		ITM280□
YITM460	46.0	170	65	40	40			

### ITM(YITM) Thread mill, Recommended cutting parameter

Material	Vc m/min	f mm/rev.
Grey cast iron	80~100	0.05~0.1
Nodular cast iron	80~100	0.05~0.1
Alloy steel	70~115	0.05~0.2
Hardened steel	60~100	0.05~0.1
Stainless steel	100~140	0.05~0.15
Aluminum	100~180	0.1~0.3

\* When thread mill approaches to the hole entry, above feed rate require about 70% reduction.

# ITM Carbide Thread mill inserts, ISO Internal

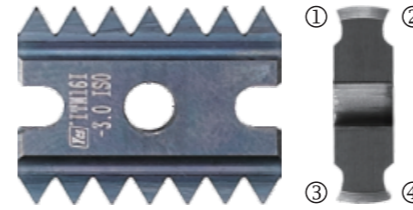

**ITM** Carbide Thread mill inserts

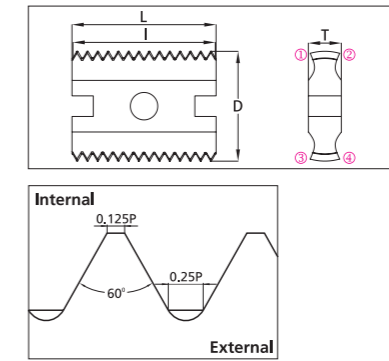

- ▶ Multi 4 flutes thread edges
- ▶ Precision ground carbide insert
- ▶ Strong clamping by cap screw and insert pocket
- ▶ TiAlN coated insert(standard)

### ISO Internal

Insert Code	Pitch	I	L	D	T	Cutting edges	Tool Holder
ITM080I-0.50 ISO	0.5	12	12	6.5	2.4	2	YITM090 YITM095 YITM100
ITM080I-0.75 ISO	0.75	12					
ITM080I-1.00 ISO	1	12					
ITM080I-1.25 ISO	1.25	11.25					
ITM080I-1.50 ISO	1.5	12	14	9.5	2.6	4	YITM115 YITM125 YITM140
ITM100I-0.75 ISO	0.75	13.5					
ITM100I-1.00 ISO	1	14					
ITM100I-1.25 ISO	1.25	13.75					
ITM100I-1.50 ISO	1.5	13.5					
ITM100I-1.75 ISO	1.75	14					
ITM100I-2.00 ISO	2	14	16	12.5	3.6	4	YITM150 YITM170
ITM130I-1.00 ISO	1	16					
ITM130I-1.25 ISO	1.25	15					
ITM130I-1.50 ISO	1.5	15					
ITM130I-1.75 ISO	1.75	15.75					
ITM130I-2.00 ISO	2	16					
ITM130I-2.50 ISO	2.5	15	21	16	4.8	4	YITM190 YITM210 YITM250
ITM160I-1.00 ISO	1	21					
ITM160I-1.75 ISO	1.75	21					
ITM160I-2.00 ISO	2	20					
ITM160I-2.50 ISO	2.5	20					
ITM160I-3.00 ISO	3	21					
ITM160I-3.50 ISO	3.5	21	30	22	5.6	4	YITM285 YITM310 YITM380
ITM220I-1.50 ISO	1.5	30					
ITM220I-2.00 ISO	2	30					
ITM220I-3.00 ISO	3	30					
ITM220I-3.50 ISO	3.5	28					
ITM220I-4.00 ISO	4	28					
ITM220I-4.50 ISO	4.5	27	40	28	6.4	4	YITM420 YITM460
ITM220I-5.00 ISO	5	30					
ITM280I-1.50 ISO	1.5	39					
ITM280I-2.00 ISO	2	40					
ITM280I-3.00 ISO	3	39					
ITM280I-3.50 ISO	3.5	38.5					
ITM280I-4.00 ISO	4	40					
ITM280I-4.50 ISO	4.5	36	5	40	38.5	4	
ITM280I-5.00 ISO	5	40					
ITM280I-5.50 ISO	5.5	38.5					
ITM280I-6.00 ISO	6	36					



# ITM Carbide Thread mill inserts, ISO External

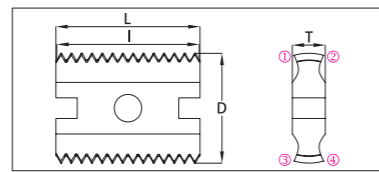
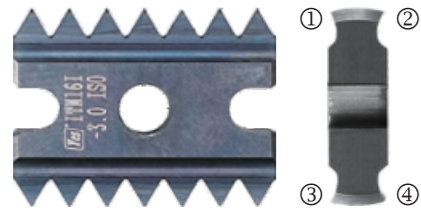

- ▶ Multi 4 flutes thread edges
- ▶ Precision ground carbide insert
- ▶ Strong clamping by cap screw and insert pocket
- ▶ TiAlN coated insert(standard)

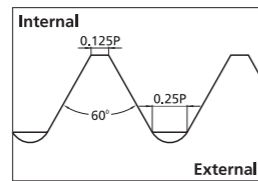

**ITM** Carbide Thread mill inserts

## ISO External

Insert Code	Pitch	I	L	D	T	Cutting edges	Tool Holder
ITM100E-0.75 ISO	0.75	13.5	14	9.5	2.6	4	YITM115 YITM125 YITM140
ITM100E-1.00 ISO	1	14					
ITM100E-1.25 ISO	1.25	13.75					
ITM100E-1.50 ISO	1.5	13.5					
ITM100E-1.75 ISO	0.75	14					
ITM100E-2.00 ISO	2	14					
ITM130E-1.00 ISO	1	16	16	12.5	3.6	4	YITM150 YITM170
ITM130E-1.25 ISO	1.25	15					
ITM130E-1.50 ISO	1.5	15					
ITM130E-1.75 ISO	1.75	15.75					
ITM130E-2.00 ISO	2	16					
ITM130E-2.50 ISO	2.5	15					
ITM160E-1.00 ISO	1	21	21	16	4.8	4	YITM190 YITM210 YITM250
ITM160E-1.50 ISO	1.5	21					
ITM160E-2.00 ISO	2	20					
ITM160E-2.50 ISO	2.5	20					
ITM160E-3.00 ISO	3	21					
ITM220E-1.50 ISO	1.5	30	30	22	5.6	4	YITM285 YITM310 YITM380
ITM220E-2.00 ISO	2	30					
ITM220E-3.00 ISO	3	30					
ITM220E-3.50 ISO	3.5	28					
ITM220E-4.00 ISO	4	28					
ITM280E-1.50 ISO	1.5	39	40	28	6.4	4	YITM420 YITM460
ITM280E-2.00 ISO	2	40					
ITM280E-3.00 ISO	3	39					
ITM280E-4.00 ISO	4	40					
ITM280E-5.00 ISO	5	40					
ITM280E-6.00 ISO	6	36					



# ITM Carbide Thread mill inserts, UN Internal

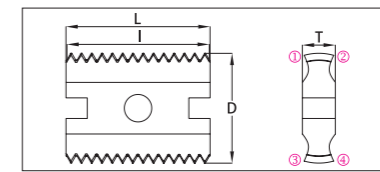
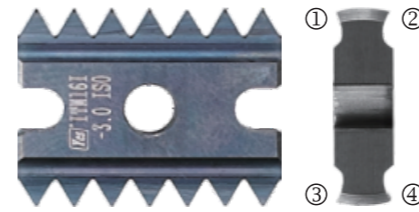

- ▶ Multi 4 flutes thread edges
- ▶ Precision ground carbide insert
- ▶ Strong clamping by cap screw and insert pocket
- ▶ TiAlN coated insert(standard)

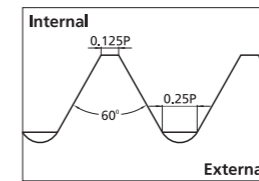

**ITM** Carbide Thread mill inserts

## UN Internal

Insert Code	TPI	I	L	D	T	Cutting edges	Tool Holder					
ITM080I-32UN	32	11.91	12	6.5	2.4	2	YITM090 YITM095 YITM100					
ITM080I-28UN	28	11.79										
ITM080I-24UN	24	11.64										
ITM080I-20UN	20	11.25										
ITM080I-18UN	18	11.43										
ITM080I-16UN	18	11.11										
ITM100I-32UN	32	13.49	14	9.5	2.6	4	YITM115 YITM125 YITM140					
ITM100I-28UN	28	13.61										
ITM100I-27UN	27	14.11										
ITM100I-24UN	24	13.76										
ITM100I-20UN	20	13.97										
ITM100I-18UN	18	14.11										
ITM100I-16UN	16	12.7										
ITM100I-14UN	14	12.7										
ITM100I-12UN	12	12.7										
ITM100I-11UN	11	13.85										
ITM130I-32UN	32	15.88	16	12.5	3.6	4	YITM150 YITM170					
ITM130I-28UN	28	15.42										
ITM130I-27UN	27	15.99										
ITM130I-24UN	24	15.88										
ITM130I-20UN	20	15.24										
ITM130I-18UN	18	15.52										
ITM130I-16UN	16	15.88										
ITM130I-14UN	14	14.51										
ITM130I-12UN	12	14.82										
ITM130I-11UN	11	16.16										
ITM130I-10UN	10	15.24										
ITM160I-24UN	24	20.11						21	16	4.8	4	YITM190 YITM210 YITM250
ITM160I-20UN	20	20.32										
ITM160I-18UN	18	19.76										
ITM160I-16UN	16	20.64										
ITM160I-14UN	14	19.96										
ITM160I-12UN	12	21.17										
ITM160I-10UN	10	20.32										
ITM160I-8UN	8	19.05										
ITM160I-7UN	7	21.77										
ITM220I-20UN	20	29.21	30	22	5.6	4	YITM285 YITM310 YITM380					
ITM220I-18UN	18	29.63										
ITM220I-16UN	16	28.58										
ITM220I-14UN	14	29.03										
ITM220I-12UN	12	29.63										
ITM220I-10UN	10	27.94										
ITM220I-8UN	8	28.58										
ITM220I-6UN	6	29.63										
ITM220I-5UN	5	30.48										
ITM280I-16UN	16	39.69						40	28	6.4	4	YITM420 YITM460
ITM280I-14UN	14	39.91										
ITM280I-12UN	12	38.1										
ITM280I-10UN	10	38.1										
ITM280I-8UN	8	38.1										
ITM280I-6UN	6	38.1										
ITM280I-4.5UN	4.5	39.51										
ITM280I-4UN	4	38.1										





# ITM Carbide Thread mill inserts, UN External

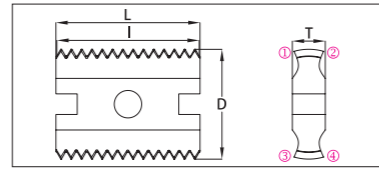
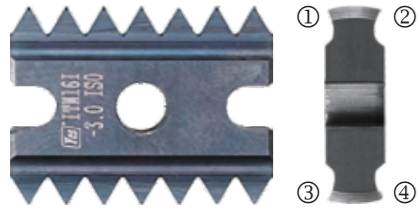

- ▶ Multi 4 flutes thread edges
- ▶ Precision ground carbide insert
- ▶ Strong clamping by cap screw and insert pocket
- ▶ TiAlN coated insert(standard)

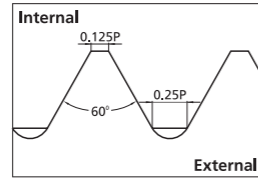

**ITM** Carbide Thread mill inserts

UN External

Insert Code	TPI	I	L	D	T	Cutting edges	Tool Holder					
ITM100E-32UN	32	13.49	14	9.5	2.6	4	YITM115 YITM125 YITM140					
ITM100E-28UN	28	13.61										
ITM100E-24UN	24	13.76										
ITM100E-20UN	20	13.97										
ITM100E-18UN	18	14.11										
ITM100E-16UN	16	12.7										
ITM100E-14UN	14	12.7										
ITM100E-12UN	12	12.7										
ITM130E-32UN	32	15.88						16	12.5	3.6	4	YITM150 YITM170
ITM130E-28UN	28	15.42										
ITM130E-27UN	27	15.99										
ITM130E-24UN	24	15.88										
ITM130E-20UN	20	15.24										
ITM130E-18UN	18	15.52										
ITM130E-16UN	16	15.88										
ITM130E-14UN	14	14.52										
ITM130E-12UN	12	14.82										
ITM130E-11UN	11	16.16										
ITM130E-10UN	10	15.24	21	16	4.8	4	YITM190 YITM210 YITM250					
ITM160E-24UN	24	20.11										
ITM160E-20UN	20	20.32										
ITM160E-18UN	18	19.76										
ITM160E-16UN	16	20.64										
ITM160E-14UN	14	19.96										
ITM160E-12UN	12	21.17										
ITM160E-10UN	10	20.32										
ITM220E-20UN	20	29.21						30	22	5.6	4	YITM285 YITM310 YITM380
ITM220E-18UN	18	29.63										
ITM220E-16UN	16	28.58										
ITM220E-14UN	14	29.03										
ITM220E-12UN	12	29.63										
ITM220E-10UN	10	27.94										
ITM220E-8UN	8	28.58										
ITM220E-6UN	6	29.63										
ITM280E-16UN	16	39.69	40	28	6.4	4	YITM420 YITM460					
ITM280E-14UN	14	39.91										
ITM280E-12UN	12	38.1										
ITM280E-10UN	10	38.1										
ITM280E-8UN	8	38.1										
ITM280E-6UN	6	38.1										



# ITM Carbide Thread mill inserts, NPS, NPSF Internal, External

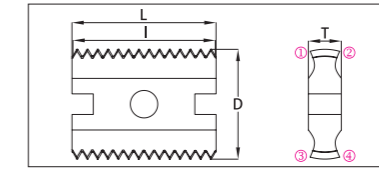
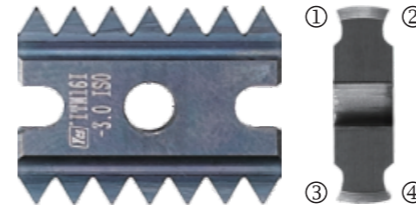

- ▶ Multi 4 flutes thread edges
- ▶ Precision ground carbide insert
- ▶ Strong clamping by cap screw and insert pocket
- ▶ TiAlN coated insert(standard)

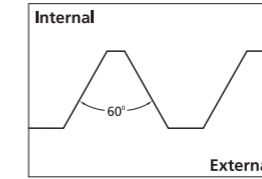

**ITM** Carbide Thread mill inserts

NPS, NPSF Internal, External

Insert Code	Pitch	I	L	D	T	Cutting edges	Tool Holder
ITM080-18NPS	18	11.29	12	6.5	2.4	4	YITM090 / YITM095 / YITM100
ITM100-18NPS	18	12.7					
ITM100-14NPS	14	12.7	14	9.5	2.6	4	YITM115 / YITM125 / YITM140
ITM130-18NPS	18	15.52					
ITM130-14NPS	14	14.51	16	12.5	3.6	4	YITM150 / YITM170
ITM130-11.5NPS	11.5	15.46					
ITM160-14NPS	14	19.96	21	16	4.8	4	YITM190 / YITM210 / YITM250
ITM160-11.5NPS	11.5	19.88					
ITM220-11.5NPS	11.5	28.71	30	22	5.6	4	YITM285 / YITM310 / YITM380
ITM220-8NPS	8	28.58					
ITM280-11.5NPS	11.5	39.76	40	28	6.4	4	YITM420 / YITM460
ITM280-8NPS	8	38.1					



# ITM Carbide Thread mill inserts, NPT, NPTF Internal, External

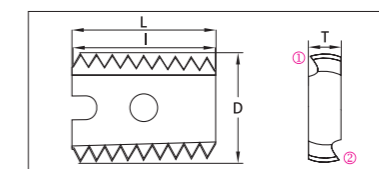
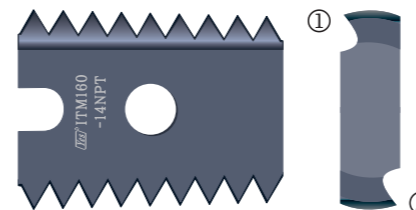

- ▶ Multi 2 flutes thread edges
- ▶ Precision ground carbide insert
- ▶ Strong clamping by cap screw and insert pocket
- ▶ TiAlN coated insert(standard)

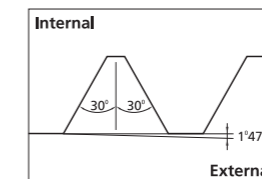

**ITM** Carbide Thread mill inserts

NPT, NPTF Internal, External

Insert Code	Pitch	I	L	D	T	Cutting edges	Tool Holder
ITM080-18NPT	18	11.29	12	6.5	2.4	2	YITM090 / YITM095 / YITM100
ITM100-18NPT	18	12.7					
ITM100-14NPT	14	12.7	14	9.5	2.6	2	YITM115 / YITM125 / YITM140
ITM130-18NPT	18	15.52					
ITM130-14NPT	14	14.51	16	12.5	3.6	2	YITM150 / YITM170
ITM130-11.5NPT	11.5	15.46					
ITM160-14NPT	14	19.96	21	16	4.8	2	YITM190 / YITM210 / YITM250
ITM160-11.5NPT	11.5	19.88					
ITM220-11.5NPT	11.5	28.71	30	22	5.6	2	YITM285 / YITM310 / YITM380
ITM220-8NPT	8	28.58					
ITM280-11.5NPT	11.5	39.76	40	28	6.4	2	YITM420 / YITM460
ITM280-8NPT	8	38.1					

# KRUZ special step drill body

Combination drill bodies (Perform multiple operations with one tool)



- ▶ Helically fluted drill body with through spindle coolant for easy chip evacuation.
- ▶ Special bodies use standard YESTOOL drill inserts (ID, IDP, IDF). Uses ISO standard facing & chamfering inserts.
- ▶ All inserts lock from the side-no removing body to replace inserts.
- ▶ Reduced cycle times result in higher productivity at reduced costs.

Special  
**KRUZ**

For Price Quote Specify Style of Tool and Fill Out Per Below

**Note:**  
[More helpful information to design if provided](#)  
Kind of Material to be machined :  
Shank style (HA, HB, HE or special) :  
Type of chamfer or facing insert (if any) :  
Coolant through or no coolant :  
Work-piece drawing if avail. :

# "One-Pass" Indexable Drilling & Deburring system

YESTOOL's new patented strong sheet spring design



- ▶ Enables drilling & deburring of both top and bottom of hole in one operation
- ▶ Drill body uses standard replaceable YESTOOL drilling insert
- ▶ Cutting tension adjustable by screw
- ▶ "DBI" deburring insert replaceable by removing square bar
- ▶ Inserts can be replaced without removing the drill body from the machine
- ▶ Can be designed for different depth and chamfer angle

**KRUZ/DB** "One-Pass" Indexable Drilling & Deburring bodies

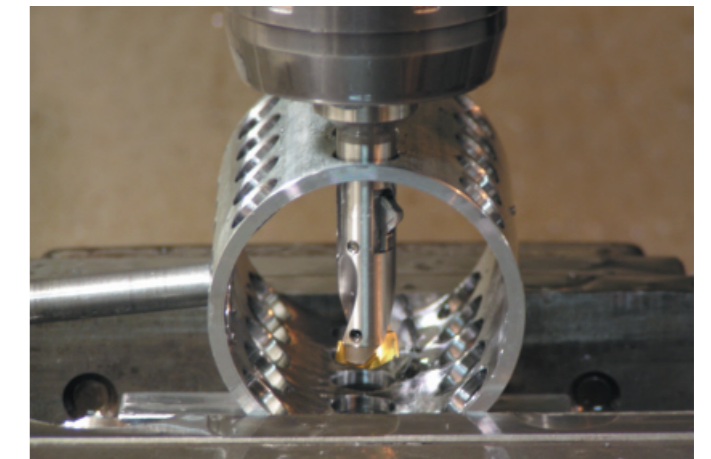

\* Note : Fixed chamfer length (like C=1.0) is not available, but chamfer approximately

# Easy torque driver

- ▶ Easier to tighten cap screw when assembly carbide insert
- ▶ Ideally protect over-torque by click sound
- ▶ To avoid torx screw damage by excessive tightening of conventional driver

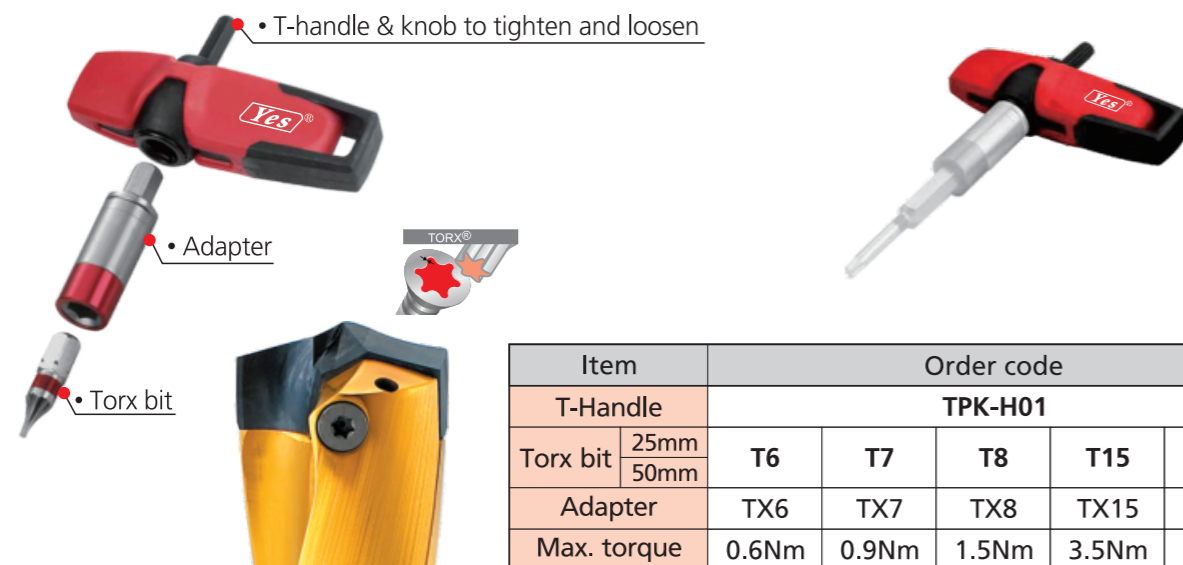

Item	Order code					
T-Handle	TPK-H01					
Torx bit	25mm	T6	T7	T8	T15	T20
	50mm					
Adapter	TX6	TX7	TX8	TX15	TX20	
Max. torque	0.6Nm	0.9Nm	1.5Nm	3.5Nm	5.0Nm	

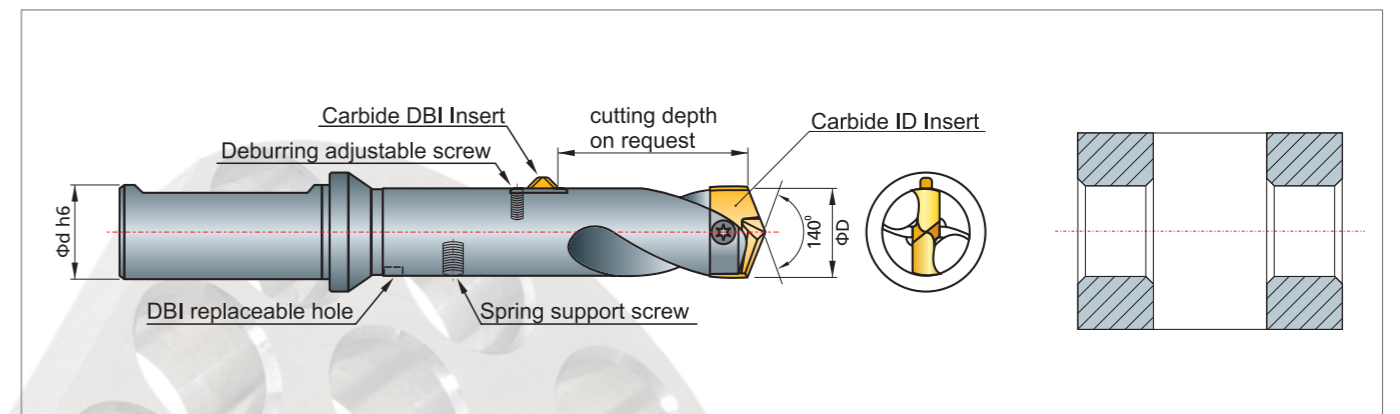

Reduce machining cost and increase productivity with YESTOOL "One-Pass" drilling system.

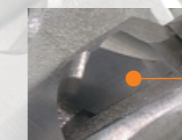

DBI insert remove the burr on the front and back side of hole. The insert retracts automatically when the tool passes through the hole.



# YTRI Indexable Reamer

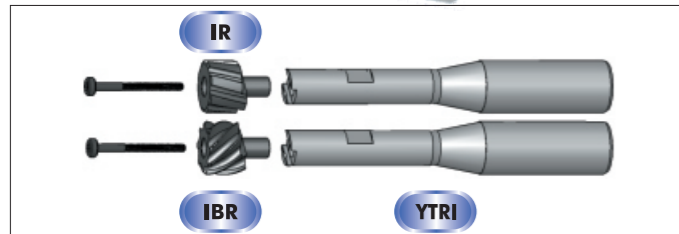

- ▶ Interchangeable Carbide Reamer insert
- ▶ Economical usage for large size over 15mm
- ▶ Locking by center head cap-screw
- ▶ IR : Right helix spiral multi-flutes
- ▶ IBR : Left helix broach reamer insert
- ▶ Speedy reaming available with H7 tolerance

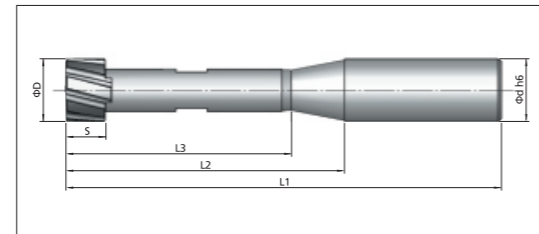

Please make required cutting depth in the □ like T, P.

Body code No.	Shank d	S	T(3 x Dia.)			P(5 x Dia.)			Applicable IR, IBR	Cap screw M	No. of flute
			L1	L2	L3	L1	L2	L3			
YTRI 150-174 □	20	7.4	114	64	53	148	98	87	IR 150~174, IBR 150~174	M2.5x30	6
YTRI 175-199 □		9.4	125	75	61	165	115	101	IR 175~199, IBR 175~199	M2.5x30	
YTRI 200-224 □		9.3	136	86	69	180	130	113	IR 200~224, IBR 200~224	M3x35	
YTRI 225-249 □	25	10.6	153	97	75	203	147	125	IR 225~249, IBR 225~249	M4x40	8
YTRI 250-274 □		10.4	158	102	82	213	157	137	IR 250~274, IBR 250~274	M5x45	
YTRI 275-299 □	32	12.2	177	117	90	237	177	150	IR 275~299, IBR 275~299	M5x45	10
YTRI 300-324 □		13.1	183	123	96	248	188	161	IR 300~324, IBR 300~324	M6x40	
YTRI 325-349 □		13.8	190	130	103	260	200	173	IR 325~349, IBR 325~349	M6x45	
YTRI 350-374 □	40	14.6	215	145	110	290	220	185	IR 350~374, IBR 350~374	M8x50	12
YTRI 375-400 □		15.4	222	152	117	302	232	197	IR 375~400, IBR 375~400	M8x50	

\* Note : Bottom edge geometry for blind hole is available as special

# KRUZ Combination Chamfer Tool

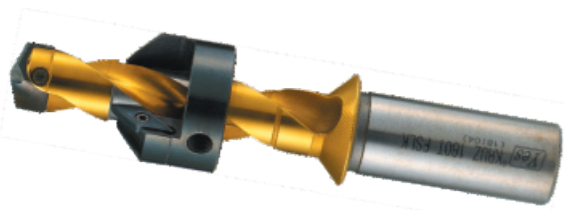

- ▶ Combination chamfer ring to fit in modified standard KRUZ body
- ▶ YCHR chamfer ring with two XCGX 1102 chamfer inserts
- ▶ Two set screws supported on the KRUZ body flute part
- ▶ Available size from KRUZ body dia.8.0~50.0mm
- ▶ Special made to order after hearing cutting depth requirement

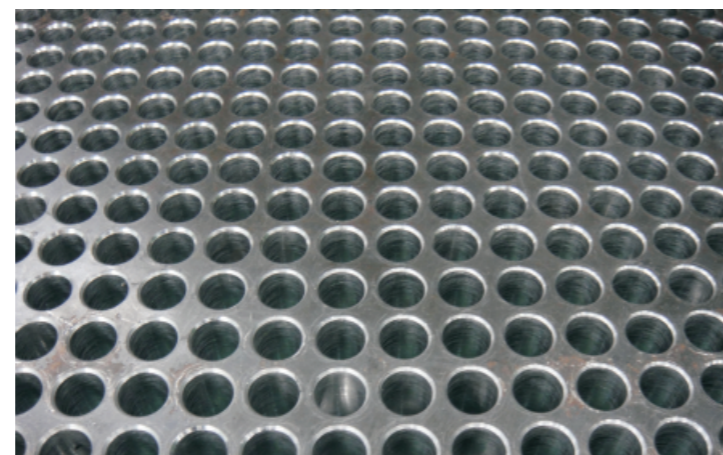
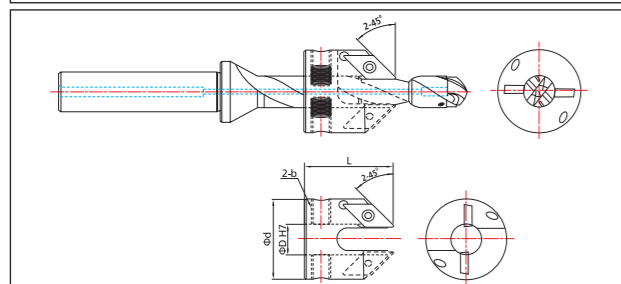

# Carbide Tipped Drill, Metric



YTD

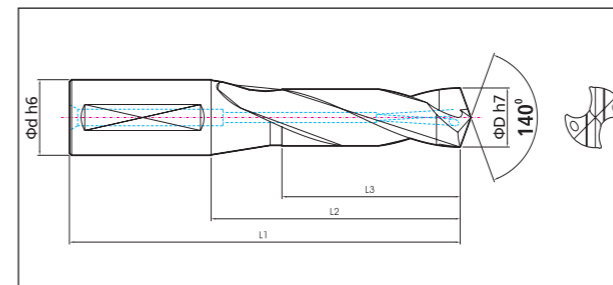

## Model : YTD

- ▶ Carbide Brazed Tipped drill, HB shank, Internal coolant hole.
- ▶ 140° self-centering point for accurate hole positioning. Regular helix angle : 25°.
- ▶ Drill body consists of heat-treated tool steel and cutting edge is brazed with carbide tip.

## Carbide substrate:

- ▶ Ultra-fine Micro Grain, TiN & TiAlN coated.

## Application

- ▶ To perform heavy drilling operation and ideal for high productivity.
- ▶ Specially designed for powerful machine. Effective cutting depth 3xDia.
- ▶ Broad range application from general to tough material.

Code No.	D	d	L1	L2	L3	Code No.	D	d	L1	L2	L3	Code No.	D	d	L1	L2	L3
YTD 135	13.5	16.0	115	67	48	YTD 166	16.6	20.0	140	90	66	YTD 197	19.7	25.0	160	104	76
YTD 136	13.6					YTD 167	16.7					YTD 198	19.8				
YTD 137	13.7					YTD 168	16.8					YTD 199	19.9				
YTD 138	13.8					YTD 169	16.9					YTD 200	20.0				
YTD 139	13.9					YTD 170	17.0					YTD 201	20.1				
YTD 140	14.0					YTD 171	17.1					YTD 202	20.2				
YTD 141	14.1					YTD 172	17.2					YTD 203	20.3				
YTD 142	14.2					YTD 173	17.3					YTD 204	20.4				
YTD 143	14.3					YTD 174	17.4					YTD 205	20.5				
YTD 144	14.4					YTD 175	17.5					YTD 206	20.6				
YTD 145	14.5	YTD 176	17.6	YTD 207	20.7												
YTD 146	14.6	20.0	130	80	59	YTD 208	20.8	25.0	155	99	73	YTD 209	20.9				
YTD 147	14.7					YTD 177	17.7					YTD 210	21.0				
YTD 148	14.8					YTD 178	17.8					YTD 211	21.1				
YTD 149	14.9					YTD 179	17.9					YTD 212	21.2				
YTD 150	15.0					YTD 180	18.0					YTD 213	21.3				
YTD 151	15.1					YTD 181	18.1					YTD 214	21.4				
YTD 152	15.2					YTD 182	18.2					YTD 215	21.5				
YTD 153	15.3					YTD 183	18.3					YTD 216	21.6				
YTD 154	15.4					YTD 184	18.4					YTD 217	21.7				
YTD 155	15.5					YTD 185	18.5					YTD 218	21.8				
YTD 156	15.6	YTD 186	18.6	YTD 219	21.9												
YTD 157	15.7	YTD 187	18.7	YTD 220	22.0												
YTD 158	15.8	YTD 188	18.8	YTD 221	22.1												
YTD 159	15.9	YTD 189	18.9	YTD 222	22.2												
YTD 160	16.0	YTD 190	19.0	YTD 223	22.3												
YTD 161	16.1	YTD 191	19.1	YTD 224	22.4												
YTD 162	16.2	YTD 192	19.2	YTD 225	22.5												
YTD 163	16.3	YTD 193	19.3	YTD 226	22.6												
YTD 164	16.4	YTD 194	19.4	YTD 227	22.7												
YTD 165	16.5	YTD 195	19.5														
		YTD 196	19.6														

Code No.	D	d	L1	L2	L3	Code No.	D	d	L1	L2	L3	Code No.	D	d	L1	L2	L3	
YTD 228	22.8	25.0	160	104	76	YTD 291	29.1	32.0	185	125	92	YTD 354	35.4	230	160	113	YTD 415	41.5
YTD 229	22.9					YTD 292	29.2					YTD 355	35.5				YTD 412	41.2
YTD 230	23.0					YTD 293	29.3					YTD 356	35.6				YTD 413	41.3
YTD 231	23.1					YTD 294	29.4					YTD 357	35.7				YTD 414	41.4
YTD 232	23.2					YTD 295	29.5					YTD 358	35.8				YTD 411	41.1
YTD 233	23.3					YTD 296	29.6					YTD 359	35.9				YTD 410	41.0
YTD 234	23.4					YTD 297	29.7					YTD 360	36.0				YTD 409	40.9
YTD 235	23.5	YTD 298	29.8	YTD 361	36.1	YTD 408	40.8											
YTD 236	23.6	YTD 299	29.9	YTD 362	36.2	YTD 407	40.7											
YTD 237	23.7	YTD 300	30.0	YTD 363	36.3	YTD 406	40.6											
YTD 238	23.8	170	110	79	YTD 301	30.1	YTD 364	36.4	40.0	240	170	119	YTD 405	40.5				
YTD 239	23.9				YTD 302	30.2	YTD 365	36.5					YTD 404	40.4				
YTD 240	24.0				YTD 303	30.3	YTD 366	36.6					YTD 403	40.3				
YTD 241	24.1				YTD 304	30.4	YTD 367	36.7					YTD 402	40.2				
YTD 242	24.2				YTD 305	30.5	YTD 368	36.8					YTD 401	40.1				
YTD 243	24.3				YTD 306	30.6	YTD 369	36.9					YTD 400	40.0				
YTD 244	24.4				YTD 307	30.7	YTD 370	37.0					YTD 399	39.9				
YTD 245	24.5				YTD 308	30.8	YTD 371	37.1					YTD 398	39.8				
YTD 246	24.6				YTD 309	30.9	YTD 372	37.2					YTD 397	39.7				
YTD 247	24.7				YTD 310	31.0	YTD 373	37.3					YTD 396	39.6				
YTD 248	24.8	175	115	83	YTD 311	31.1	YTD 374	37.4	40.0	250	180	122	YTD 395	39.5				
YTD 249	24.9				YTD 312	31.2	YTD 375	37.5					YTD 394	39.4				
YTD 250	25.0				YTD 313	31.3	YTD 376	37.6					YTD 393	39.3				
YTD 251	25.1				YTD 314	31.4	YTD 377	37.7					YTD 392	39.2				
YTD 252	25.2				YTD 315	31.5	YTD 378	37.8					YTD 391	39.1				
YTD 253	25.3				YTD 316	31.6	YTD 379	37.9					YTD 390	39.0				
YTD 254	25.4				YTD 317	31.7	YTD 380	38.0					YTD 389	38.9				
YTD 255	25.5				YTD 318	31.8	YTD 381	38.1					YTD 388	38.8				
YTD 256	25.6				YTD 319	31.9	YTD 382	38.2					YTD 387	38.7				
YTD 257	25.7				YTD 320	32.0	YTD 383	38.3					YTD 386	38.6				
YTD 258	25.8	185	125	92	YTD 321	32.1	YTD 384	38.4	40.0	230	160	113	YTD 385	38.5				
YTD 259	25.9				YTD 322	32.2	YTD 385	38.5					YTD 384	38.4				
YTD 260	26.0				YTD 323	32.3	YTD 386	38.6					YTD 383	38.3				
YTD 261	26.1				YTD 324	32.4	YTD 387	38.7					YTD 382	38.2				
YTD 262	26.2				YTD 325	32.5	YTD 388	38.8					YTD 381	38.1				
YTD 263	26.3				YTD 326	32.6	YTD 389	38.9					YTD 380	38.0				
YTD 264	26.4				YTD 327	32.7	YTD 390	39.0					YTD 379	37.9				
YTD 265	26.5				YTD 328	32.8	YTD 391	39.1					YTD 378	37.8				
YTD 266	26.6				YTD 329	32.9	YTD 392	39.2					YTD 377	37.7				
YTD 267	26.7				YTD 330	33.0	YTD 393	39.3					YTD 376	37.6				
YTD 268	26.8	170	110	79	YTD 331	33.1	YTD 394	39.4	40.0	240	170	119	YTD 395	39.5				
YTD 269	26.9				YTD 332	33.2	YTD 395	39.5					YTD 394	39.4				
YTD 270	27.0				YTD 333	33.3	YTD 396	39.6					YTD 393	39.3				
YTD 271	27.1				YTD 334	33.4	YTD 397	39.7					YTD 392	39.2				
YTD 272	27.2				YTD 335	33.5	YTD 398	39.8					YTD 391	39.1				
YTD 273	27.3				YTD 336	33.6	YTD 399	39.9					YTD 390	39.0				
YTD 274	27.4				YTD 337	33.7	YTD 400	40.0					YTD 389	38.9				
YTD 275	27.5				YTD 338	33.8	YTD 401	40.1					YTD 388	38.8				
YTD 276	27.6				YTD 339	33.9	YTD 402	40.2					YTD 387	38.7				
YTD 277	27.7				YTD 340	34.0	YTD 403	40.3					YTD 386	38.6				
YTD 278	27.8	185	125	92	YTD 341	34.1	YTD 404	40.4	40.0	250	180	122	YTD 385	38.5				
YTD 279	27.9				YTD 342	34.2	YTD 405	40.5					YTD 403	40.3				
YTD 280	28.0				YTD 343	34.3	YTD 406	40.6					YTD 402	40.2				
YTD 281	28.1				YTD 344	34.4	YTD 407	40.7					YTD 401	40.1				
YTD 282	28.2				YTD 345	34.5	YTD 408	40.8					YTD 400	40.0				
YTD 283	28.3				YTD 346	34.6	YTD 409	40.9					YTD 399	39.9				
YTD 284	28.4				YTD 347	34.7	YTD 410	41.0					YTD 398	39.8				
YTD 285	28.5				YTD 348	34.8	YTD 411	41.1					YTD 397	39.7				
YTD 286	28.6				YTD 349	34.9	YTD 412	41.2					YTD 396	39.6				
YTD 287	28.7				YTD 350	35.0	YTD 413	41.3					YTD 395	39.5				
YTD 288	28.8	230	160	113	YTD 351	35.1	YTD 414	41.4	40.0	230	160	113	YTD 394	39.4				
YTD 289	28.9				YTD 352	35.2	YTD 415	41.5					YTD 413	41.3				
YTD 290	29.0				YTD 353	35.3	YTD 414	41.4					YTD 412	41.2				



YTD

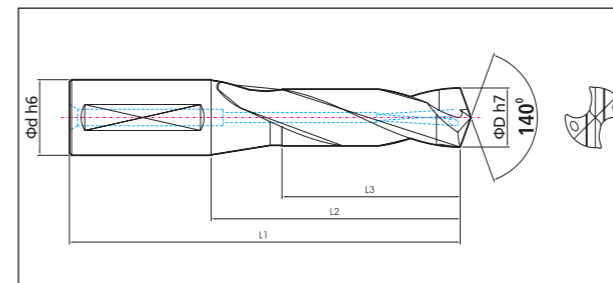

\* Inch YTD available upon request only.

Code No.	D	d	L1	L2	L3
YTD .5310	0.531	0.625	4.52	2.63	1.88
YTD .5460	0.546				
YTD .5620	0.562				
YTD .5780	0.578				
YTD .5930	0.593	0.750	5.11	3.14	2.32
YTD .6090	0.609				
YTD .6250	0.625				
YTD .6400	0.640				
YTD .6560	0.656	0.750	5.51	3.54	2.59
YTD .6710	0.671				
YTD .6870	0.687				
YTD .7030	0.703				
YTD .7180	0.718	1.000	6.10	3.89	2.87
YTD .7340	0.734				
YTD .7500	0.750				
YTD .7650	0.765				
YTD .7810	0.781				
YTD .7960	0.796				
YTD .8120	0.812				
YTD .8280	0.828				
YTD .8430	0.843				
YTD .8590	0.859				
YTD .8750	0.875	1.500	6.29	4.09	2.99
YTD .8900	0.890				
YTD .9060	0.906				
YTD .9210	0.921				
YTD .9370	0.937				
YTD .9530	0.953				
YTD .9680	0.968				
YTD .9840	0.984				
YTD1 .0000	1.000				
YTD1 .0150	1.015				
YTD1 .0310	1.031				
YTD1 .0460	1.046				
YTD1 .0620	1.062				
YTD1 .0780	1.078				
YTD1 .0930	1.093				
YTD1 .1090	1.109				
YTD1 .1250	1.125				
YTD1 .1400	1.140				
YTD1 .1560	1.156				
YTD1 .1710	1.171				
YTD1 .1870	1.187				
YTD1 .2500	1.250				
YTD1 .3120	1.312				
YTD1 .3430	1.343				
YTD1 .3750	1.375				
YTD1 .4210	1.421				
YTD1 .4370	1.437				
YTD1 .5000	1.500				
YTD1 .5620	1.562				
YTD1 .6250	1.625				

### Model : YTD

- ▶ Carbide Brazed Tipped drill, HB shank, Internal coolant hole.
- ▶ 140° self-centering point for accurate hole positioning. Regular helix angle : 25°.
- ▶ Drill body consists of heat-treated tool steel and cutting edge is brazed with carbide tip.

### Carbide substrate:

- ▶ Ultra-fine Micro Grain, TiN & TiAlN coated.

### Application

- ▶ To perform heavy drilling operation and ideal for high productivity.
- ▶ Specially designed for powerful machine. Effective cutting depth 3xDia.
- ▶ Broad range application from general to tough material.

Code No.	D	d	L1	L2	L3
YTD .9370	0.937	1.250	6.69	4.33	3.11
YTD .9530	0.953				
YTD .9680	0.968				
YTD .9840	0.984				
YTD1 .0000	1.000	1.250	6.88	4.52	3.26
YTD1 .0150	1.015				
YTD1 .0310	1.031				
YTD1 .0460	1.046				
YTD1 .0620	1.062				
YTD1 .0780	1.078				
YTD1 .0930	1.093				
YTD1 .1090	1.109				
YTD1 .1250	1.125				
YTD1 .1400	1.140				
YTD1 .1560	1.156				
YTD1 .1710	1.171				
YTD1 .1870	1.187				
YTD1 .2500	1.250	1.500	7.28	4.92	3.62
YTD1 .3120	1.312				
YTD1 .3430	1.343				
YTD1 .3750	1.375				
YTD1 .4210	1.421				
YTD1 .4370	1.437				
YTD1 .5000	1.500	1.500	8.26	5.51	3.85
YTD1 .5620	1.562				
YTD1 .6250	1.625				
YTD1 .6250	1.625				
YTD1 .6250	1.625				



# Carbide Tipped Drill, Long Series, Metric

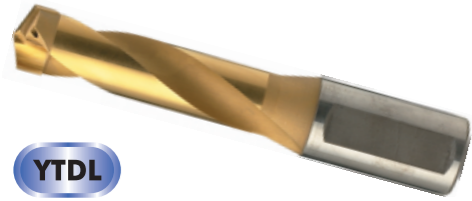

YTDL

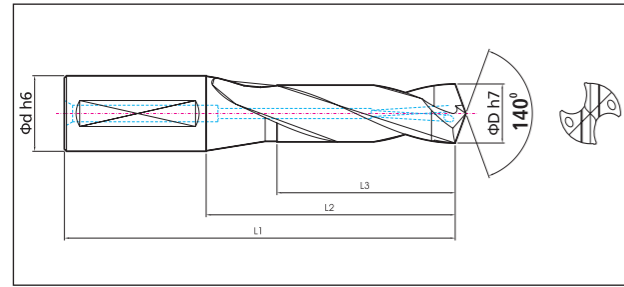

### Model : YTDL

- ▶ Carbide Brazed Tipped drill, HB shank, Internal coolant hole, long series.
- ▶ 140° self-centering point for accurate hole positioning. Regular helix angle : 25°.
- ▶ Drill body consists of heat-treated tool steel and cutting edge is brazed with carbide tip.

### Carbide substrate:

- ▶ Ultra-fine Micro Grain, TiN & TiAlN coated.

### Application

- ▶ To perform heavy drilling operation and ideal for high productivity.
- ▶ Specially designed for powerful machine. Effective cutting depth 5xDia.
- ▶ Broad range application from general to tough material.

Code No.	D	d	L1	L2	L3
YTDL 135	13.5	16.0	145	97	73
YTDL 136	13.6				
YTDL 137	13.7				
YTDL 138	13.8				
YTDL 139	13.9				
YTDL 140	14.0				
YTDL 141	14.1				
YTDL 142	14.2				
YTDL 143	14.3				
YTDL 144	14.4				
YTDL 145	14.5				
YTDL 146	14.6	20.0	165	115	94
YTDL 147	14.7				
YTDL 148	14.8				
YTDL 149	14.9				
YTDL 150	15.0				
YTDL 151	15.1				
YTDL 152	15.2				
YTDL 153	15.3				
YTDL 154	15.4				
YTDL 155	15.5				
YTDL 156	15.6				
YTDL 157	15.7				
YTDL 158	15.8				
YTDL 159	15.9				
YTDL 160	16.0				
YTDL 161	16.1				
YTDL 162	16.2				
YTDL 163	16.3				
YTDL 164	16.4				
YTDL 165	16.5				

Code No.	D	d	L1	L2	L3
YTDL 166	16.6	20.0	175	125	101
YTDL 167	16.7				
YTDL 168	16.8				
YTDL 169	16.9				
YTDL 170	17.0				
YTDL 171	17.1				
YTDL 172	17.2				
YTDL 173	17.3				
YTDL 174	17.4				
YTDL 175	17.5				
YTDL 176	17.6				
YTDL 177	17.7	25.0	195	139	112
YTDL 178	17.8				
YTDL 179	17.9				
YTDL 180	18.0				
YTDL 181	18.1				
YTDL 182	18.2				
YTDL 183	18.3				
YTDL 184	18.4				
YTDL 185	18.5				
YTDL 186	18.6				
YTDL 187	18.7				
YTDL 188	18.8				
YTDL 189	18.9				
YTDL 190	19.0				
YTDL 191	19.1				
YTDL 192	19.2				
YTDL 193	19.3				
YTDL 194	19.4				
YTDL 195	19.5				
YTDL 196	19.6				

Code No.	D	d	L1	L2	L3
YTDL 197	19.7	25.0	210	154	124
YTDL 198	19.8				
YTDL 199	19.9				
YTDL 200	20.0				
YTDL 201	20.1				
YTDL 202	20.2				
YTDL 203	20.3				
YTDL 204	20.4				
YTDL 205	20.5				
YTDL 206	20.6				
YTDL 207	20.7				
YTDL 208	20.8	32.0	235	175	141
YTDL 209	20.9				
YTDL 210	21.0				
YTDL 211	21.1				
YTDL 212	21.2				
YTDL 213	21.3				
YTDL 214	21.4				
YTDL 215	21.5				
YTDL 216	21.6				
YTDL 217	21.7				
YTDL 218	21.8				
YTDL 219	21.9				
YTDL 220	22.0				
YTDL 221	22.1				
YTDL 222	22.2				
YTDL 223	22.3				
YTDL 224	22.4				
YTDL 225	22.5				
YTDL 226	22.6				
YTDL 227	22.7				

Code No.	D	d	L1	L2	L3
YTDL 228	22.8	25.0	210	154	124
YTDL 229	22.9				
YTDL 230	23.0				
YTDL 231	23.1				
YTDL 232	23.2				
YTDL 233	23.3				
YTDL 234	23.4				
YTDL 235	23.5				
YTDL 236	23.6				
YTDL 237	23.7				
YTDL 238	23.8	225	165	133	
YTDL 239	23.9				
YTDL 240	24.0				
YTDL 241	24.1				
YTDL 242	24.2				
YTDL 243	24.3				
YTDL 244	24.4				
YTDL 245	24.5				
YTDL 246	24.6				
YTDL 247	24.7				
YTDL 248	24.8				
YTDL 249	24.9				
YTDL 250	25.0	32.0	235	175	141
YTDL 251	25.1				
YTDL 252	25.2				
YTDL 253	25.3				
YTDL 254	25.4				
YTDL 255	25.5				
YTDL 256	25.6				
YTDL 257	25.7				
YTDL 258	25.8				
YTDL 259	25.9				
YTDL 260	26.0				
YTDL 261	26.1				
YTDL 262	26.2				
YTDL 263	26.3				
YTDL 264	26.4				
YTDL 265	26.5				
YTDL 266	26.6				
YTDL 267	26.7				
YTDL 268	26.8				
YTDL 269	26.9				
YTDL 270	27.0	25.0	210	154	124
YTDL 271	27.1				
YTDL 272	27.2				
YTDL 273	27.3				
YTDL 274	27.4				
YTDL 275	27.5				
YTDL 276	27.6				
YTDL 277	27.7				
YTDL 278	27.8				
YTDL 279	27.9				
YTDL 280	28.0				
YTDL 281	28.1				
YTDL 282	28.2				
YTDL 283	28.3				
YTDL 284	28.4				
YTDL 285	28.5				
YTDL 286	28.6				
YTDL 287	28.7				
YTDL 288	28.8				
YTDL 289	28.9				
YTDL 290	29.0				

Code No.	D	d	L1	L2	L3
YTDL 291	29.1	32.0	245	185	148
YTDL 292	29.2				
YTDL 293	29.3				
YTDL 294	29.4				
YTDL 295	29.5				
YTDL 296	29.6				
YTDL 297	29.7				
YTDL 298	29.8				
YTDL 299	29.9				
YTDL 300	30.0				
YTDL 301	30.1	255	195	157	
YTDL 302	30.2				
YTDL 303	30.3				
YTDL 304	30.4				
YTDL 305	30.5				
YTDL 306	30.6				
YTDL 307	30.7				
YTDL 308	30.8				
YTDL 309	30.9				
YTDL 310	31.0				
YTDL 311	31.1				
YTDL 312	31.2				
YTDL 313	31.3				
YTDL 314	31.4				
YTDL 315	31.5				
YTDL 316	31.6				
YTDL 317	31.7				
YTDL 318	31.8				
YTDL 319	31.9				
YTDL 320	32.0	280	210	172	
YTDL 321	32.1				
YTDL 322	32.2				
YTDL 323	32.3				
YTDL 324	32.4				
YTDL 325	32.5				
YTDL 326	32.6				
YTDL 327	32.7				
YTDL 328	32.8				
YTDL 329	32.9				
YTDL 330	33.0				
YTDL 331	33.1				
YTDL 332	33.2				
YTDL 333	33.3				
YTDL 334	33.4				
YTDL 335	33.5				
YTDL 336	33.6				
YTDL 337	33.7				
YTDL 338	33.8				
YTDL 339	33.9				
YTDL 340	34.0				
YTDL 341	34.1				
YTDL 342	34.2				
YTDL 343	34.3				
YTDL 344	34.4				
YTDL 345	34.5				
YTDL 346	34.6				
YTDL 347	34.7				
YTDL 348	34.8				
YTDL 349	34.9				
YTDL 350	35.0				
YTDL 351	35.1				
YTDL 352	35.2				
YTDL 353	35.3				

Code No.	D	d	L1	L2	L3
YTDL 354	35.4	300	230	183	
YTDL 355	35.5				
YTDL 356	35.6				
YTDL 357	35.7				
YTDL 358	35.8				
YTDL 359	35.9				
YTDL 360	36.0				
YTDL 361	36.1				
YTDL 362	36.2				
YTDL 363	36.3				
YTDL 364	36.4				
YTDL 365	36.5				
YTDL 366	36.6				
YTDL 367	36.7				
YTDL 368	36.8				
YTDL 369	36.9				
YTDL 370	37.0				
YTDL 371	37.1				
YTDL 372	37.2				
YTDL 373	37.3				
YTDL 374	37.4				
YTDL 375	37.5				
YTDL 376	37.6				
YTDL 377	37.7				
YTDL 378	37.8				
YTDL 379	37.9				
YTDL 380	38.0				
YTDL 381	38.1				
YTDL 382	38.2				
YTDL 383	38.3				
YTDL 384	38.4				
YTDL 385	38.5				
YTDL 386	38.6				
YTDL 387	38.7				
YTDL 388	38.8				
YTDL 389	38.9				
YTDL 390	39.0				
YTDL 391	39.1				
YTDL 392	39.2				
YTDL 393	39.3				
YTDL 394	39.4				
YTDL 395	39.5				
YTDL 396	39.6				
YTDL 397	39.7				
YTDL 398	39.8				
YTDL 399	39.9				
YTDL 400	40.0				
YTDL 401	40.1				
YTDL 402	40.2				
YTDL 403	40.3				
YTDL 404	40.4				
YTDL 405	40.5				
YTDL 406	40.6				
YTDL 407	40.7				
YTDL 408	40.8				
YTDL 409	40.9				
YTDL 410	41.0				
YTDL 411	41.1				
YTDL 412	41.2				
YTDL 413	41.3				
YTDL 414	41.4				
YTDL 415	41.5				

# Carbide Tipped Drill, Long Series, Inch

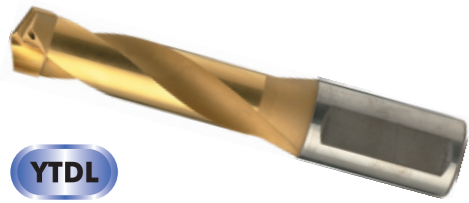

**YTDL**

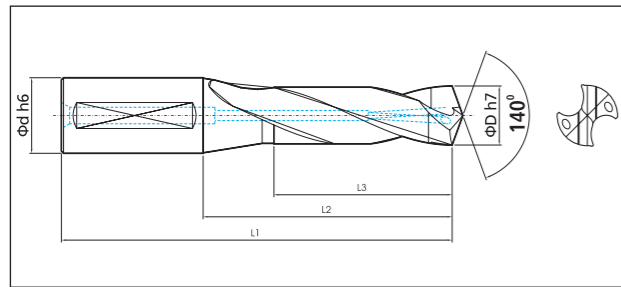

\* Inch YTD available upon request only.

### Model : YTDL

- ▶ Carbide Brazed Tipped drill, HB shank, Internal coolant hole, long series.
- ▶ 140° self-centering point for accurate hole positioning. Regular helix angle : 25°.
- ▶ Drill body consists of heat-treated tool steel and cutting edge is brazed with carbide tip.

### Carbide substrate:

- ▶ Ultra-fine Micro Grain, TiN & TiAlN coated.

### Application

- ▶ To perform heavy drilling operation and ideal for high productivity.
- ▶ Specially designed for powerful machine. Effective cutting depth 5xDia.
- ▶ Broad range application from general to tough material.

### Inch Size

Code No.	D	d	L1	L2	L3
YTDL .5310	0.531	0.625	5.70	3.81	2.87
YTDL .5460	0.546				
YTDL .5620	0.562				
YTDL .5780	0.578				
YTDL .5930	0.593	0.750	6.49	4.52	3.70
YTDL .6090	0.609				
YTDL .6250	0.625				
YTDL .6400	0.640				
YTDL .6560	0.656	1.000	7.67	5.47	4.40
YTDL .6710	0.671				
YTDL .6870	0.687				
YTDL .7030	0.703				
YTDL .7180	0.718	1.250	9.46	7.28	5.82
YTDL .7340	0.734				
YTDL .7500	0.750				
YTDL .7650	0.765				
YTDL .7810	0.781	1.500	11.81	9.05	7.20
YTDL .7960	0.796				
YTDL .8120	0.812				
YTDL .8280	0.828				
YTDL .8430	0.843	1.750	14.11	10.31	7.99
YTDL .8590	0.859				
YTDL .8750	0.875				
YTDL .8900	0.890				
YTDL .9060	0.906	2.000	16.41	11.81	8.99
YTDL .9210	0.921				

### Inch Size

Code No.	D	d	L1	L2	L3
YTDL .9370	0.937	1.250	8.85	6.49	5.23
YTDL .9530	0.953				
YTDL .9680	0.968				
YTDL .9840	0.984				
YTDL 1.0000	1.000	1.500	11.81	9.05	7.20
YTDL 1.0150	1.015				
YTDL 1.0310	1.031				
YTDL 1.0460	1.046				
YTDL 1.0620	1.062	1.750	14.11	10.31	7.99
YTDL 1.0780	1.078				
YTDL 1.0930	1.093				
YTDL 1.1090	1.109				
YTDL 1.1250	1.125	2.000	16.41	11.81	8.99
YTDL 1.1400	1.140				
YTDL 1.1560	1.156				
YTDL 1.1710	1.171				
YTDL 1.1870	1.187	2.250	18.71	13.11	9.99
YTDL 1.2030	1.203				
YTDL 1.2190	1.219				
YTDL 1.2350	1.235				
YTDL 1.2500	1.250	2.500	21.01	14.41	10.99
YTDL 1.2660	1.266				
YTDL 1.2820	1.282				
YTDL 1.2980	1.298				
YTDL 1.3120	1.312	2.750	23.31	15.71	11.99
YTDL 1.3280	1.328				
YTDL 1.3440	1.344				
YTDL 1.3600	1.360				
YTDL 1.3750	1.375	3.000	25.61	17.01	12.99
YTDL 1.3910	1.391				
YTDL 1.4070	1.407				
YTDL 1.4230	1.423				
YTDL 1.4370	1.437	3.250	27.91	18.31	13.99
YTDL 1.4530	1.453				
YTDL 1.4690	1.469				
YTDL 1.4850	1.485				
YTDL 1.5000	1.500	3.500	30.21	19.61	14.99
YTDL 1.5160	1.516				
YTDL 1.5320	1.532				
YTDL 1.5480	1.548				
YTDL 1.5620	1.562	3.750	32.51	20.91	15.99
YTDL 1.5780	1.578				
YTDL 1.5940	1.594	4.000	34.81	22.21	16.99
YTDL 1.6100	1.610				
YTDL 1.6250	1.625	4.250	37.11	23.51	17.99
YTDL 1.6410	1.641				
YTDL 1.6570	1.657	4.500	39.41	24.81	18.99
YTDL 1.6730	1.673				
YTDL 1.6890	1.689	4.750	41.71	26.11	19.99
YTDL 1.7050	1.705				
YTDL 1.7210	1.721	5.000	44.01	27.41	20.99
YTDL 1.7370	1.737				
YTDL 1.7530	1.753	5.250	46.31	28.71	21.99
YTDL 1.7690	1.769				
YTDL 1.7850	1.785	5.500	48.61	30.01	22.99
YTDL 1.8010	1.801				
YTDL 1.8170	1.817	5.750	50.91	31.31	23.99
YTDL 1.8330	1.833				
YTDL 1.8490	1.849	6.000	53.21	32.61	24.99
YTDL 1.8650	1.865				
YTDL 1.8810	1.881	6.250	55.51	33.91	25.99
YTDL 1.8970	1.897				
YTDL 1.9130	1.913	6.500	57.81	35.21	26.99
YTDL 1.9290	1.929				
YTDL 1.9450	1.945	6.750	60.11	36.51	27.99
YTDL 1.9610	1.961				
YTDL 1.9770	1.977	7.000	62.41	37.81	28.99
YTDL 1.9930	1.993				
YTDL 2.0090	2.009	7.250	64.71	39.11	29.99
YTDL 2.0250	2.025				
YTDL 2.0410	2.041	7.500	67.01	40.41	30.99
YTDL 2.0570	2.057				
YTDL 2.0730	2.073	7.750	69.31	41.71	31.99
YTDL 2.0890	2.089				
YTDL 2.1050	2.105	8.000	71.61	43.01	32.99
YTDL 2.1210	2.121				
YTDL 2.1370	2.137	8.250	73.91	44.31	33.99
YTDL 2.1530	2.153				
YTDL 2.1690	2.169	8.500	76.21	45.61	34.99
YTDL 2.1850	2.185				
YTDL 2.2010	2.201	8.750	78.51	46.91	35.99
YTDL 2.2170	2.217				
YTDL 2.2330	2.233	9.000	80.81	48.21	36.99
YTDL 2.2490	2.249				
YTDL 2.2650	2.265	9.250	83.11	49.51	37.99
YTDL 2.2810	2.281				
YTDL 2.2970	2.297	9.500	85.41	50.81	38.99
YTDL 2.3130	2.313				
YTDL 2.3290	2.329	9.750	87.71	52.11	39.99
YTDL 2.3450	2.345				
YTDL 2.3610	2.361	10.000	90.01	53.41	40.99
YTDL 2.3770	2.377				
YTDL 2.3930	2.393	10.250	92.31	54.71	41.99
YTDL 2.4090	2.409				
YTDL 2.4250	2.425	10.500	94.61	56.01	42.99
YTDL 2.4410	2.441				
YTDL 2.4570	2.457	10.750	96.91	57.31	43.99
YTDL 2.4730	2.473				
YTDL 2.4890	2.489	11.000	99.21	58.61	44.99
YTDL 2.5050	2.505				
YTDL 2.5210	2.521	11.250	101.51	59.91	45.99
YTDL 2.5370	2.537				
YTDL 2.5530	2.553	11.500	103.81	61.21	46.99
YTDL 2.5690	2.569				
YTDL 2.5850	2.585	11.750	106.11	62.51	47.99
YTDL 2.6010	2.601				
YTDL 2.6170	2.617	12.000	108.41	63.81	48.99
YTDL 2.6330	2.633				
YTDL 2.6490	2.649	12.250	110.71	65.11	49.99
YTDL 2.6650	2.665				
YTDL 2.6810	2.681	12.500	113.01	66.41	50.99
YTDL 2.6970	2.697				
YTDL 2.7130	2.713	12.750	115.31	67.71	51.99
YTDL 2.7290	2.729				
YTDL 2.7450	2.745	13.000	117.61	69.01	52.99
YTDL 2.7610	2.761				
YTDL 2.7770	2.777	13.250	119.91	70.31	53.99
YTDL 2.7930	2.793				
YTDL 2.8090	2.809	13.500	122.21	71.61	54.99
YTDL 2.8250	2.825				
YTDL 2.8410	2.841	13.750	124.51	72.91	55.99
YTDL 2.8570	2.857				
YTDL 2.8730	2.873	14.000	126.81	74.21	56.99
YTDL 2.8890	2.889				
YTDL 2.9050	2.905	14.250	129.11	75.51	57.99
YTDL 2.9210	2.921				
YTDL 2.9370	2.937	14.500	131.41	76.81	58.99
YTDL 2.9530	2.953				
YTDL 2.9690	2.969	14.750	133.71	78.11	59.99
YTDL 2.9850	2.985				
YTDL 2.9990	2.999	15.000	136.01	79.41	60.99
YTDL 3.0130	3.013				
YTDL 3.0270	3.027	15.250	138.31	80.71	61.99
YTDL 3.0410	3.041				
YTDL 3.0550	3.055	15.500	140.61	82.01	62.99
YTDL 3.0690	3.069				
YTDL 3.0830	3.083	15.750	142.91	83.31	63.99
YTDL 3.0970	3.097				
YTDL 3.1110	3.111	16.000	145.21	84.61	64.99
YTDL 3.1250	3.125				
YTDL 3.1390	3.139	16.250	147.51	85.91	65.99
YTDL 3.1530	3.153				
YTDL 3.1670	3.167	16.500	149.81	87.21	66.99
YTDL 3.1810	3.181				
YTDL 3.1950	3.195	16.750	152.11	88.51	67.99
YTDL 3.2090	3.209				
YTDL 3.2230	3.223	17.000	154.41	89.81	68.99
YTDL 3.2370	3.237				
YTDL 3.2510	3.251	17.250	156.71	91.11	69.99
YTDL 3.2650	3.265				
YTDL 3.2790	3.279	17.500	159.01	92.41	70.99
YTDL 3.2930	3.293				
YTDL 3.3070	3.307	17.750	161.31	93.71	71.99
YTDL 3.3210	3.321				
YTDL 3.3350	3.335	18.000	163.61	95.01	72.99
YTDL 3.3490	3.349				
YTDL 3.3630	3.363	18.250	165.91	96.31	73.99
YTDL 3.3770	3.377				
YTDL 3.3910	3.391	18.500	168.21	97.61	74.99
YTDL 3.4050	3.405				
YTDL 3.4190	3.419	18.750	170.51	98.91	75.99
YTDL 3.4330	3.433				
YTDL 3.4470	3.447	19.000	172.81	100.21	76.99
YTDL 3.4610	3.461				
YTDL 3.4750	3.475	19.250	175.11	101.51	77.99
YTDL 3.4890	3.489				
YTDL 3.5030	3.503	19.500	177.41	102.81	78.99
YTDL 3.5170	3.517				
YTDL 3.5310	3.531	19.750	179.71	104.11	79.99
YTDL 3.5450	3.545				
YTDL 3.5590	3.559	20.000	182.01	105.41	80.99
YTDL 3.5730	3.573				
YTDL 3.5870	3.587	20.250	184.31	106.71	81.99
YTDL 3.6010	3.601				
YTDL 3.6150	3.615	20.500	186.61	108.01	82.99
YTDL 3.6290	3.629				
YTDL 3.6430	3.643	20.750	188.91	109.31	83.99
YTDL 3.6570	3.657				
YTDL 3.6710	3.671	21.000	191.21	110.61	84.99
YTDL 3.6850	3.685				
YTDL 3.6990	3.699	21.250	193.51	111.91	85.99
YTDL 3.7130	3.713				
YTDL 3.7270	3.727	21.500	195.81	113.21	86.99
YTDL 3.7410	3.741				
YTDL 3.7550	3.755	21.750	198.11	114.51	87.99
YTDL 3.7690	3.769				
YTDL 3.7830	3.783	22.000	200.41	115.81	88.99
YTDL 3.7970	3.797				
YTDL 3.8110	3.811	22.250	202.71	117.11	89.99
YTDL 3.8250	3.825				
YTDL 3.8390	3.839	22.500	205.01	118.41	90.99
YTDL 3.8530	3.853				
YTDL 3.8670	3.867	22.750	207.31	119.71	91.99
YTDL 3.8810	3.881				
YTDL 3.8950	3.895				





# Solid Carbide "F" (flat bottom) point drills

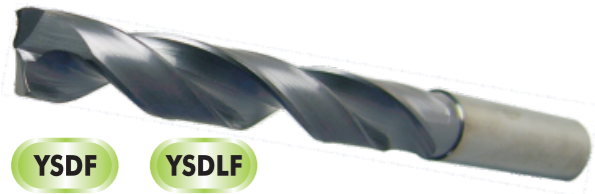

YSDF YSDLF

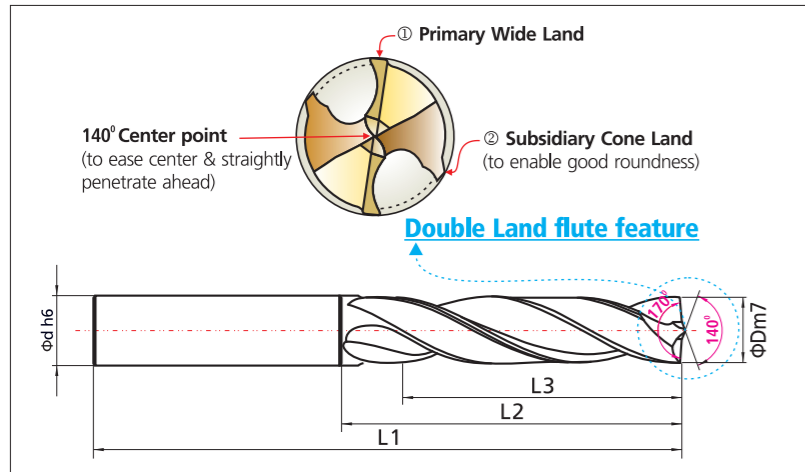

"F" point test photo as below

Drill : YSDLF 100 TiAlN  
Material : SCM440(42CrMo4)  
rpm : 2,000  
f : 0.2mm/rev (F : 400mm/min)

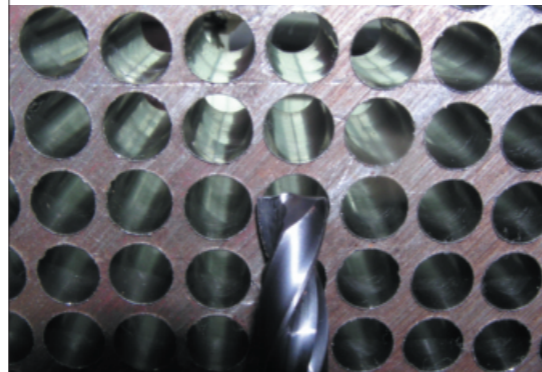

## YSDF - Solid Carbide "F" Point Drill

Code No.	D	d	L1	L2	L3
YSDF 030-035	3.0-3.5	4	55	20	15
YSDF 036-041	3.6-4.1			25	19
YSDF 042-051	4.2-5.1	5	62	32	25
YSDF 052-061	5.2-6.1	6	66	36	27
YSDF 062-071	6.2-7.1	7	74	42	32
YSDF 072-081	7.2-8.1	8	79	46	34
YSDF 082-091	8.2-9.1	9	84	50	37
YSDF 092-101	9.2-10.1	10	89	53	38
YSDF 102-111	10.2-11.1	11	95	55	40
YSDF 112-121	11.2-12.1	12	102	62	44
YSDF 122-131	12.2-13.1	13			42
YSDF 132-141	13.2-14.1	14	107	64	43
YSDF 142-151	14.2-15.1	15	111	67	45
YSDF 152-161	15.2-16.1	16	115	69	
YSDF 162-171	16.2-17.1	17	119	71	46
YSDF 172-181	17.2-18.1	18	123	74	47
YSDF 182-191	18.2-19.1	19	127	76	48
YSDF 192-200	19.2-20.0	20	131	80	50

- Note : "F" point drill is available on request.

### Application example.

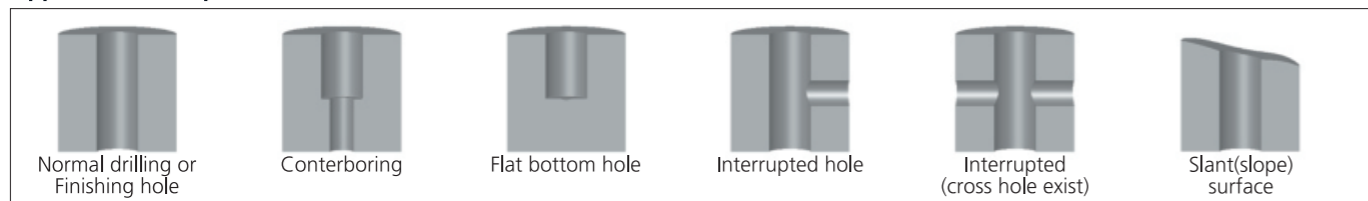

# Solid Carbide "P" (Premium) point Drill



YSDP

YSDLP

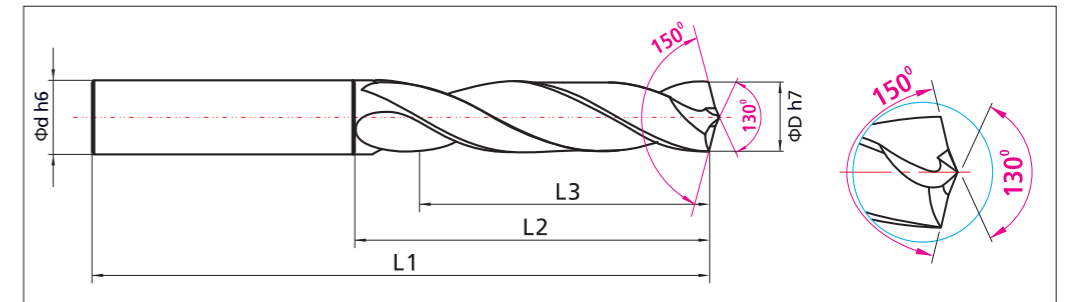

- ▶ New premium dual point design (130° center+150° side edges)
- ▶ Enables Deep hole drilling
- ▶ Minimized vibration
- ▶ Higher penetration
- ▶ Faster chip evacuation rate
- ▶ Available with newest coating "Y+" to increase tool life

## YSDP - Solid Carbide "P" Point Drill

Code No.	D	d	L1	L2	L3
YSDP 030-035	3.0-3.5	4	55	20	15
YSDP 036-041	3.6-4.1			25	19
YSDP 042-051	4.2-5.1	5	62	32	25
YSDP 052-061	5.2-6.1	6	66	36	27
YSDP 062-071	6.2-7.1	7	74	42	32
YSDP 072-081	7.2-8.1	8	79	46	34
YSDP 082-091	8.2-9.1	9	84	50	37
YSDP 092-101	9.2-10.1	10	89	53	38
YSDP 102-111	10.2-11.1	11	95	55	40
YSDP 112-121	11.2-12.1	12	102	62	44
YSDP 122-131	12.2-13.1	13			42
YSDP 132-141	13.2-14.1	14	107	64	43
YSDP 142-151	14.2-15.1	15	111	67	45
YSDP 152-161	15.2-16.1	16	115	69	
YSDP 162-171	16.2-17.1	17	119	71	46
YSDP 172-181	17.2-18.1	18	123	74	47
YSDP 182-191	18.2-19.1	19	127	76	48
YSDP 192-200	19.2-20.0	20	131	80	50

- Note : "P" point drill is available on request.

## YSDLP - Solid Carbide "P" Point Long Drill

Code No.	D	d	L1	L2	L3
YSDLP 030-035	3.0-3.5	4	80	45	40
YSDLP 036-041	3.6-4.1				39
YSDLP 042-051	4.2-5.1	5	62	32	38
YSDLP 052-061	5.2-6.1	6	66	36	41
YSDLP 062-071	6.2-7.1	7	74	42	43
YSDLP 072-081	7.2-8.1	8	79	46	46
YSDLP 082-091	8.2-9.1	9	84	50	51
YSDLP 092-101	9.2-10.1	10	89	53	53
YSDLP 102-111	10.2-11.1	11	95	55	57
YSDLP 112-121	11.2-12.1	12	120	80	62
YSDLP 122-131	12.2-13.1	13			71
YSDLP 132-141	13.2-14.1	14	137	90	75
YSDLP 142-151	14.2-15.1	15	147	96	88
YSDLP 152-161	15.2-16.1	16	160	112	87
YSDLP 162-171	16.2-17.1	17			85
YSDLP 172-181	17.2-18.1	18	123	74	84
YSDLP 182-191	18.2-19.1	19	127	76	82
YSDLP 192-200	19.2-20.0	20	131	80	82



# Solid Carbide Drill, **Metric**



**YSD TiN**



**YSD TiAlN**

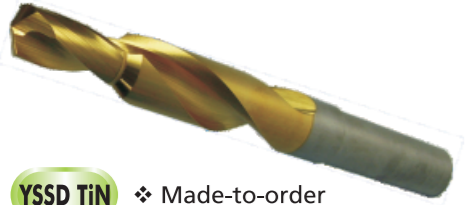

**YSSD TiN** ❖ Made-to-order

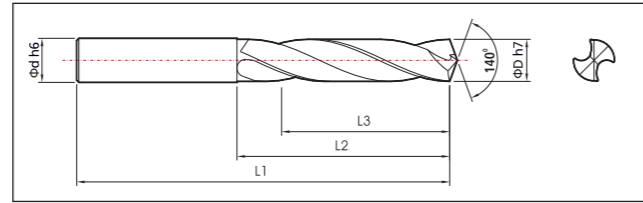

## Model : YSD

- ▶ Solid Carbide drill, Yes standard length, Plain cylindrical HA shank.
- ▶ Effective cutting depth 3xDia. Whistle notch HE shank available on request)
- ▶ 140° self-centering point for accurate hole positioning. regular helix angle : 28° ~ 30°.
- ▶ Manufactured with heavy duty construction and excellent chip evacuation.
- ▶ High performance carbide drill and re-sharpening & re-conditioning available

## Carbide substrate

- ▶ Ultra-fine Micro Grain, PVD TiN, TiAlN coated as standard stock.

## Application

- ▶ To eliminate the need for center drilling and partially reaming. Highest hole quality and tolerance.
- ▶ Specially designed for machining center or CNC application.
- ▶ Broad range application from general to tough material.

Code No.	D	d	L1	L2	L3	Code No.	D	d	L1	L2	L3	Code No.	D	d	L1	L2	L3																																																				
YSD 030	3.0	4.0	55	20	15	YSD 042	4.2	5.0	62	32	25	YSD 052	5.2	6.0	66	36	27																																																				
YSD 031	3.1					YSD 032	3.2					YSD 033	3.3					YSD 034	3.4	YSD 035	3.5	YSD 036	3.6	YSD 037	3.7	YSD 038	3.8	YSD 039	3.9	YSD 040	4.0	YSD 041	4.1	YSD 043	4.3	YSD 044	4.4	YSD 045	4.5	YSD 046	4.6	YSD 047	4.7	YSD 048	4.8	YSD 049	4.9	YSD 050	5.0	YSD 051	5.1	YSD 053	5.3	YSD 054	5.4	YSD 055	5.5	YSD 056	5.6	YSD 057	5.7	YSD 058	5.8	YSD 059	5.9	YSD 060	6.0	YSD 061	6.1
YSD 032	3.2					YSD 033	3.3					YSD 034	3.4					YSD 035	3.5	YSD 036	3.6	YSD 037	3.7	YSD 038	3.8	YSD 039	3.9	YSD 040	4.0	YSD 041	4.1	YSD 043	4.3	YSD 044	4.4	YSD 045	4.5	YSD 046	4.6	YSD 047	4.7	YSD 048	4.8	YSD 049	4.9	YSD 050	5.0	YSD 051	5.1	YSD 053	5.3	YSD 054	5.4	YSD 055	5.5	YSD 056	5.6	YSD 057	5.7	YSD 058	5.8	YSD 059	5.9	YSD 060	6.0	YSD 061	6.1		
YSD 033	3.3					YSD 034	3.4					YSD 035	3.5					YSD 036	3.6	YSD 037	3.7	YSD 038	3.8	YSD 039	3.9	YSD 040	4.0	YSD 041	4.1	YSD 043	4.3	YSD 044	4.4	YSD 045	4.5	YSD 046	4.6	YSD 047	4.7	YSD 048	4.8	YSD 049	4.9	YSD 050	5.0	YSD 051	5.1	YSD 053	5.3	YSD 054	5.4	YSD 055	5.5	YSD 056	5.6	YSD 057	5.7	YSD 058	5.8	YSD 059	5.9	YSD 060	6.0	YSD 061	6.1				
YSD 034	3.4					YSD 035	3.5					YSD 036	3.6					YSD 037	3.7	YSD 038	3.8	YSD 039	3.9	YSD 040	4.0	YSD 041	4.1	YSD 043	4.3	YSD 044	4.4	YSD 045	4.5	YSD 046	4.6	YSD 047	4.7	YSD 048	4.8	YSD 049	4.9	YSD 050	5.0	YSD 051	5.1	YSD 053	5.3	YSD 054	5.4	YSD 055	5.5	YSD 056	5.6	YSD 057	5.7	YSD 058	5.8	YSD 059	5.9	YSD 060	6.0	YSD 061	6.1						
YSD 035	3.5			YSD 036	3.6	YSD 037	3.7					YSD 038	3.8					YSD 039	3.9	YSD 040	4.0	YSD 041	4.1	YSD 043	4.3	YSD 044	4.4	YSD 045	4.5	YSD 046	4.6	YSD 047	4.7	YSD 048	4.8	YSD 049	4.9	YSD 050	5.0	YSD 051	5.1	YSD 053	5.3	YSD 054	5.4	YSD 055	5.5	YSD 056	5.6	YSD 057	5.7	YSD 058	5.8	YSD 059	5.9	YSD 060	6.0	YSD 061	6.1										
YSD 036	3.6			YSD 037	3.7	YSD 038	3.8					YSD 039	3.9					YSD 040	4.0	YSD 041	4.1	YSD 043	4.3	YSD 044	4.4	YSD 045	4.5	YSD 046	4.6	YSD 047	4.7	YSD 048	4.8	YSD 049	4.9	YSD 050	5.0	YSD 051	5.1	YSD 053	5.3	YSD 054	5.4	YSD 055	5.5	YSD 056	5.6	YSD 057	5.7	YSD 058	5.8	YSD 059	5.9	YSD 060	6.0	YSD 061	6.1												
YSD 037	3.7			YSD 038	3.8	YSD 039	3.9					YSD 040	4.0					YSD 041	4.1	YSD 043	4.3	YSD 044	4.4	YSD 045	4.5	YSD 046	4.6	YSD 047	4.7	YSD 048	4.8	YSD 049	4.9	YSD 050	5.0	YSD 051	5.1	YSD 053	5.3	YSD 054	5.4	YSD 055	5.5	YSD 056	5.6	YSD 057	5.7	YSD 058	5.8	YSD 059	5.9	YSD 060	6.0	YSD 061	6.1														
YSD 038	3.8			YSD 039	3.9	YSD 040	4.0					YSD 041	4.1					YSD 043	4.3	YSD 044	4.4	YSD 045	4.5	YSD 046	4.6	YSD 047	4.7	YSD 048	4.8	YSD 049	4.9	YSD 050	5.0	YSD 051	5.1	YSD 053	5.3	YSD 054	5.4	YSD 055	5.5	YSD 056	5.6	YSD 057	5.7	YSD 058	5.8	YSD 059	5.9	YSD 060	6.0	YSD 061	6.1																
YSD 039	3.9			YSD 040	4.0	YSD 041	4.1					YSD 043	4.3					YSD 044	4.4	YSD 045	4.5	YSD 046	4.6	YSD 047	4.7	YSD 048	4.8	YSD 049	4.9	YSD 050	5.0	YSD 051	5.1	YSD 053	5.3	YSD 054	5.4	YSD 055	5.5	YSD 056	5.6	YSD 057	5.7	YSD 058	5.8	YSD 059	5.9	YSD 060	6.0	YSD 061	6.1																		
YSD 040	4.0	YSD 041	4.1	YSD 043	4.3	YSD 044	4.4	YSD 045	4.5	YSD 046	4.6	YSD 047	4.7	YSD 048	4.8	YSD 049	4.9	YSD 050	5.0	YSD 051	5.1	YSD 053	5.3	YSD 054	5.4	YSD 055	5.5	YSD 056	5.6	YSD 057	5.7	YSD 058	5.8	YSD 059	5.9	YSD 060	6.0	YSD 061	6.1																														
YSD 041	4.1	YSD 043	4.3	YSD 044	4.4	YSD 045	4.5	YSD 046	4.6	YSD 047	4.7	YSD 048	4.8	YSD 049	4.9	YSD 050	5.0	YSD 051	5.1	YSD 053	5.3	YSD 054	5.4	YSD 055	5.5	YSD 056	5.6	YSD 057	5.7	YSD 058	5.8	YSD 059	5.9	YSD 060	6.0	YSD 061	6.1																																
YSD 043	4.3	YSD 044	4.4	YSD 045	4.5	YSD 046	4.6	YSD 047	4.7	YSD 048	4.8	YSD 049	4.9	YSD 050	5.0	YSD 051	5.1	YSD 053	5.3	YSD 054	5.4	YSD 055	5.5	YSD 056	5.6	YSD 057	5.7	YSD 058	5.8	YSD 059	5.9	YSD 060	6.0	YSD 061	6.1																																		
YSD 044	4.4	YSD 045	4.5	YSD 046	4.6	YSD 047	4.7	YSD 048	4.8	YSD 049	4.9	YSD 050	5.0	YSD 051	5.1	YSD 053	5.3	YSD 054	5.4	YSD 055	5.5	YSD 056	5.6	YSD 057	5.7	YSD 058	5.8	YSD 059	5.9	YSD 060	6.0	YSD 061	6.1																																				
YSD 045	4.5	YSD 046	4.6	YSD 047	4.7	YSD 048	4.8	YSD 049	4.9	YSD 050	5.0	YSD 051	5.1	YSD 053	5.3	YSD 054	5.4	YSD 055	5.5	YSD 056	5.6	YSD 057	5.7	YSD 058	5.8	YSD 059	5.9	YSD 060	6.0	YSD 061	6.1																																						
YSD 046	4.6	YSD 047	4.7	YSD 048	4.8	YSD 049	4.9	YSD 050	5.0	YSD 051	5.1	YSD 053	5.3	YSD 054	5.4	YSD 055	5.5	YSD 056	5.6	YSD 057	5.7	YSD 058	5.8	YSD 059	5.9	YSD 060	6.0	YSD 061	6.1																																								
YSD 047	4.7	YSD 048	4.8	YSD 049	4.9	YSD 050	5.0	YSD 051	5.1	YSD 053	5.3	YSD 054	5.4	YSD 055	5.5	YSD 056	5.6	YSD 057	5.7	YSD 058	5.8	YSD 059	5.9	YSD 060	6.0	YSD 061	6.1																																										
YSD 048	4.8	YSD 049	4.9	YSD 050	5.0	YSD 051	5.1	YSD 053	5.3	YSD 054	5.4	YSD 055	5.5	YSD 056	5.6	YSD 057	5.7	YSD 058	5.8	YSD 059	5.9	YSD 060	6.0	YSD 061	6.1																																												
YSD 049	4.9	YSD 050	5.0	YSD 051	5.1	YSD 053	5.3	YSD 054	5.4	YSD 055	5.5	YSD 056	5.6	YSD 057	5.7	YSD 058	5.8	YSD 059	5.9	YSD 060	6.0	YSD 061	6.1																																														
YSD 050	5.0	YSD 051	5.1	YSD 053	5.3	YSD 054	5.4	YSD 055	5.5	YSD 056	5.6	YSD 057	5.7	YSD 058	5.8	YSD 059	5.9	YSD 060	6.0	YSD 061	6.1																																																
YSD 051	5.1	YSD 053	5.3	YSD 054	5.4	YSD 055	5.5	YSD 056	5.6	YSD 057	5.7	YSD 058	5.8	YSD 059	5.9	YSD 060	6.0	YSD 061	6.1																																																		
YSD 053	5.3	YSD 054	5.4	YSD 055	5.5	YSD 056	5.6	YSD 057	5.7	YSD 058	5.8	YSD 059	5.9	YSD 060	6.0	YSD 061	6.1																																																				
YSD 054	5.4	YSD 055	5.5	YSD 056	5.6	YSD 057	5.7	YSD 058	5.8	YSD 059	5.9	YSD 060	6.0	YSD 061	6.1																																																						
YSD 055	5.5	YSD 056	5.6	YSD 057	5.7	YSD 058	5.8	YSD 059	5.9	YSD 060	6.0	YSD 061	6.1																																																								
YSD 056	5.6	YSD 057	5.7	YSD 058	5.8	YSD 059	5.9	YSD 060	6.0	YSD 061	6.1																																																										
YSD 057	5.7	YSD 058	5.8	YSD 059	5.9	YSD 060	6.0	YSD 061	6.1																																																												
YSD 058	5.8	YSD 059	5.9	YSD 060	6.0	YSD 061	6.1																																																														
YSD 059	5.9	YSD 060	6.0	YSD 061	6.1																																																																
YSD 060	6.0	YSD 061	6.1																																																																		
YSD 061	6.1																																																																				

Code No.	D	d	L1	L2	L3	Code No.	D	d	L1	L2	L3	Code No.	D	d	L1	L2	L3																																																																																																																																																																																																																																																																										
YSD 062	6.2	7.0	74	42	32	YSD 112	11.2	12.0	102	62	44	YSD 162	16.2	17.0	119	71	46																																																																																																																																																																																																																																																																										
YSD 063	6.3					YSD 064	6.4					YSD 065	6.5					YSD 066	6.6	YSD 067	6.7	YSD 068	6.8	YSD 069	6.9	YSD 070	7.0	YSD 071	7.1	YSD 072	7.2	YSD 073	7.3	YSD 074	7.4	YSD 075	7.5	YSD 076	7.6	YSD 077	7.7	YSD 078	7.8	YSD 079	7.9	YSD 080	8.0	YSD 081	8.1	YSD 082	8.2	YSD 083	8.3	YSD 084	8.4	YSD 085	8.5	YSD 086	8.6	YSD 087	8.7	YSD 088	8.8	YSD 089	8.9	YSD 090	9.0	YSD 091	9.1	YSD 092	9.2	YSD 093	9.3	YSD 094	9.4	YSD 095	9.5	YSD 096	9.6	YSD 097	9.7	YSD 098	9.8	YSD 099	9.9	YSD 100	10.0	YSD 101	10.1	YSD 102	10.2	YSD 103	10.3	YSD 104	10.4	YSD 105	10.5	YSD 106	10.6	YSD 107	10.7	YSD 108	10.8	YSD 109	10.9	YSD 110	11.0	YSD 111	11.1	YSD 113	11.3	YSD 114	11.4	YSD 115	11.5	YSD 116	11.6	YSD 117	11.7	YSD 118	11.8	YSD 119	11.9	YSD 120	12.0	YSD 121	12.1	YSD 122	12.2	YSD 123	12.3	YSD 124	12.4	YSD 125	12.5	YSD 126	12.6	YSD 127	12.7	YSD 128	12.8	YSD 129	12.9	YSD 130	13.0	YSD 131	13.1	YSD 132	13.2	YSD 133	13.3	YSD 134	13.4	YSD 135	13.5	YSD 136	13.6	YSD 137	13.7	YSD 138	13.8	YSD 139	13.9	YSD 140	14.0	YSD 141	14.1	YSD 142	14.2	YSD 143	14.3	YSD 144	14.4	YSD 145	14.5	YSD 146	14.6	YSD 147	14.7	YSD 148	14.8	YSD 149	14.9	YSD 150	15.0	YSD 151	15.1	YSD 152	15.2	YSD 153	15.3	YSD 154	15.4	YSD 155	15.5	YSD 156	15.6	YSD 157	15.7	YSD 158	15.8	YSD 159	15.9	YSD 160	16.0	YSD 161	16.1	YSD 163	16.3	YSD 164	16.4	YSD 165	16.5	YSD 166	16.6	YSD 167	16.7	YSD 168	16.8	YSD 169	16.9	YSD 170	17.0	YSD 171	17.1	YSD 172	17.2	YSD 173	17.3	YSD 174	17.4	YSD 175	17.5	YSD 176	17.6	YSD 177	17.7	YSD 178	17.8	YSD 179	17.9	YSD 180	18.0	YSD 181	18.1	YSD 182	18.2	YSD 183	18.3	YSD 184	18.4	YSD 185	18.5	YSD 186	18.6	YSD 187	18.7	YSD 188	18.8	YSD 189	18.9	YSD 190	19.0	YSD 191	19.1	YSD 192	19.2	YSD 193	19.3	YSD 194	19.4	YSD 195	19.5	YSD 196	19.6	YSD 197	19.7	YSD 198	19.8	YSD 199	19.9	YSD 200	20.0
YSD 064	6.4					YSD 065	6.5					YSD 066	6.6					YSD 067	6.7	YSD 068	6.8	YSD 069	6.9	YSD 070	7.0	YSD 071	7.1	YSD 072	7.2	YSD 073	7.3	YSD 074	7.4	YSD 075	7.5	YSD 076	7.6	YSD 077	7.7	YSD 078	7.8	YSD 079	7.9	YSD 080	8.0	YSD 081	8.1	YSD 082	8.2	YSD 083	8.3	YSD 084	8.4	YSD 085	8.5	YSD 086	8.6	YSD 087	8.7	YSD 088	8.8	YSD 089	8.9	YSD 090	9.0	YSD 091	9.1	YSD 092	9.2	YSD 093	9.3	YSD 094	9.4	YSD 095	9.5	YSD 096	9.6	YSD 097	9.7	YSD 098	9.8	YSD 099	9.9	YSD 100	10.0	YSD 101	10.1	YSD 102	10.2	YSD 103	10.3	YSD 104	10.4	YSD 105	10.5	YSD 106	10.6	YSD 107	10.7	YSD 108	10.8	YSD 109	10.9	YSD 110	11.0	YSD 111	11.1	YSD 113	11.3	YSD 114	11.4	YSD 115	11.5	YSD 116	11.6	YSD 117	11.7	YSD 118	11.8	YSD 119	11.9	YSD 120	12.0	YSD 121	12.1	YSD 122	12.2	YSD 123	12.3	YSD 124	12.4	YSD 125	12.5	YSD 126	12.6	YSD 127	12.7	YSD 128	12.8	YSD 129	12.9	YSD 130	13.0	YSD 131	13.1	YSD 132	13.2	YSD 133	13.3	YSD 134	13.4	YSD 135	13.5	YSD 136	13.6	YSD 137	13.7	YSD 138	13.8	YSD 139	13.9	YSD 140	14.0	YSD 141	14.1	YSD 142	14.2	YSD 143	14.3	YSD 144	14.4	YSD 145	14.5	YSD 146	14.6	YSD 147	14.7	YSD 148	14.8	YSD 149	14.9	YSD 150	15.0	YSD 151	15.1	YSD 152	15.2	YSD 153	15.3	YSD 154	15.4	YSD 155	15.5	YSD 156	15.6	YSD 157	15.7	YSD 158	15.8	YSD 159	15.9	YSD 160	16.0	YSD 161	16.1	YSD 163	16.3	YSD 164	16.4	YSD 165	16.5	YSD 166	16.6	YSD 167	16.7	YSD 168	16.8	YSD 169	16.9	YSD 170	17.0	YSD 171	17.1	YSD 172	17.2	YSD 173	17.3	YSD 174	17.4	YSD 175	17.5	YSD 176	17.6	YSD 177	17.7	YSD 178	17.8	YSD 179	17.9	YSD 180	18.0	YSD 181	18.1	YSD 182	18.2	YSD 183	18.3	YSD 184	18.4	YSD 185	18.5	YSD 186	18.6	YSD 187	18.7	YSD 188	18.8	YSD 189	18.9	YSD 190	19.0	YSD 191	19.1	YSD 192	19.2	YSD 193	19.3	YSD 194	19.4	YSD 195	19.5	YSD 196	19.6	YSD 197	19.7	YSD 198	19.8	YSD 199	19.9	YSD 200	20.0		
YSD 065	6.5					YSD 066	6.6					YSD 067	6.7					YSD 068	6.8	YSD 069	6.9	YSD 070	7.0	YSD 071	7.1	YSD 072	7.2	YSD 073	7.3	YSD 074	7.4	YSD 075	7.5	YSD 076	7.6	YSD 077	7.7	YSD 078	7.8	YSD 079	7.9	YSD 080	8.0	YSD 081	8.1	YSD 082	8.2	YSD 083	8.3	YSD 084	8.4	YSD 085	8.5	YSD 086	8.6	YSD 087	8.7	YSD 088	8.8	YSD 089	8.9	YSD 090	9.0	YSD 091	9.1	YSD 092	9.2	YSD 093	9.3	YSD 094	9.4	YSD 095	9.5	YSD 096	9.6	YSD 097	9.7	YSD 098	9.8	YSD 099	9.9	YSD 100	10.0	YSD 101	10.1	YSD 102	10.2	YSD 103	10.3	YSD 104	10.4	YSD 105	10.5	YSD 106	10.6	YSD 107	10.7	YSD 108	10.8	YSD 109	10.9	YSD 110	11.0	YSD 111	11.1	YSD 113	11.3	YSD 114	11.4	YSD 115	11.5	YSD 116	11.6	YSD 117	11.7	YSD 118	11.8	YSD 119	11.9	YSD 120	12.0	YSD 121	12.1	YSD 122	12.2	YSD 123	12.3	YSD 124	12.4	YSD 125	12.5	YSD 126	12.6	YSD 127	12.7	YSD 128	12.8	YSD 129	12.9	YSD 130	13.0	YSD 131	13.1	YSD 132	13.2	YSD 133	13.3	YSD 134	13.4	YSD 135	13.5	YSD 136	13.6	YSD 137	13.7	YSD 138	13.8	YSD 139	13.9	YSD 140	14.0	YSD 141	14.1	YSD 142	14.2	YSD 143	14.3	YSD 144	14.4	YSD 145	14.5	YSD 146	14.6	YSD 147	14.7	YSD 148	14.8	YSD 149	14.9	YSD 150	15.0	YSD 151	15.1	YSD 152	15.2	YSD 153	15.3	YSD 154	15.4	YSD 155	15.5	YSD 156	15.6	YSD 157	15.7	YSD 158	15.8	YSD 159	15.9	YSD 160	16.0	YSD 161	16.1	YSD 163	16.3	YSD 164	16.4	YSD 165	16.5	YSD 166	16.6	YSD 167	16.7	YSD 168	16.8	YSD 169	16.9	YSD 170	17.0	YSD 171	17.1	YSD 172	17.2	YSD 173	17.3	YSD 174	17.4	YSD 175	17.5	YSD 176	17.6	YSD 177	17.7	YSD 178	17.8	YSD 179	17.9	YSD 180	18.0	YSD 181	18.1	YSD 182	18.2	YSD 183	18.3	YSD 184	18.4	YSD 185	18.5	YSD 186	18.6	YSD 187	18.7	YSD 188	18.8	YSD 189	18.9	YSD 190	19.0	YSD 191	19.1	YSD 192	19.2	YSD 193	19.3	YSD 194	19.4	YSD 195	19.5	YSD 196	19.6	YSD 197	19.7	YSD 198	19.8	YSD 199	19.9	YSD 200	20.0				
YSD 066	6.6					YSD 067	6.7					YSD 068	6.8					YSD 069	6.9	YSD 070	7.0	YSD 071	7.1	YSD 072	7.2	YSD 073	7.3	YSD 074	7.4	YSD 075	7.5	YSD 076	7.6	YSD 077	7.7	YSD 078	7.8	YSD 079	7.9	YSD 080	8.0	YSD 081	8.1	YSD 082	8.2	YSD 083	8.3	YSD 084	8.4	YSD 085	8.5	YSD 086	8.6	YSD 087	8.7	YSD 088	8.8	YSD 089	8.9	YSD 090	9.0	YSD 091	9.1	YSD 092	9.2	YSD 093	9.3	YSD 094	9.4	YSD 095	9.5	YSD 096	9.6	YSD 097	9.7	YSD 098	9.8	YSD 099	9.9	YSD 100	10.0	YSD 101	10.1	YSD 102	10.2	YSD 103	10.3	YSD 104	10.4	YSD 105	10.5	YSD 106	10.6	YSD 107	10.7	YSD 108	10.8	YSD 109	10.9	YSD 110	11.0	YSD 111	11.1	YSD 113	11.3	YSD 114	11.4	YSD 115	11.5	YSD 116	11.6	YSD 117	11.7	YSD 118	11.8	YSD 119	11.9	YSD 120	12.0	YSD 121	12.1	YSD 122	12.2	YSD 123	12.3	YSD 124	12.4	YSD 125	12.5	YSD 126	12.6	YSD 127	12.7	YSD 128	12.8	YSD 129	12.9	YSD 130	13.0	YSD 131	13.1	YSD 132	13.2	YSD 133	13.3	YSD 134	13.4	YSD 135	13.5	YSD 136	13.6	YSD 137	13.7	YSD 138	13.8	YSD 139	13.9	YSD 140	14.0	YSD 141	14.1	YSD 142	14.2	YSD 143	14.3	YSD 144	14.4	YSD 145	14.5	YSD 146	14.6	YSD 147	14.7	YSD 148	14.8	YSD 149	14.9	YSD 150	15.0	YSD 151	15.1	YSD 152	15.2	YSD 153	15.3	YSD 154	15.4	YSD 155	15.5	YSD 156	15.6	YSD 157	15.7	YSD 158	15.8	YSD 159	15.9	YSD 160	16.0	YSD 161	16.1	YSD 163	16.3	YSD 164	16.4	YSD 165	16.5	YSD 166	16.6	YSD 167	16.7	YSD 168	16.8	YSD 169	16.9	YSD 170	17.0	YSD 171	17.1	YSD 172	17.2	YSD 173	17.3	YSD 174	17.4	YSD 175	17.5	YSD 176	17.6	YSD 177	17.7	YSD 178	17.8	YSD 179	17.9	YSD 180	18.0	YSD 181	18.1	YSD 182	18.2	YSD 183	18.3	YSD 184	18.4	YSD 185	18.5	YSD 186	18.6	YSD 187	18.7	YSD 188	18.8	YSD 189	18.9	YSD 190	19.0	YSD 191	19.1	YSD 192	19.2	YSD 193	19.3	YSD 194	19.4	YSD 195	19.5	YSD 196	19.6	YSD 197	19.7	YSD 198	19.8	YSD 199	19.9	YSD 200	20.0						
YSD 067	6.7					YSD 068	6.8					YSD 069	6.9					YSD 070	7.0	YSD 071	7.1	YSD 072	7.2	YSD 073	7.3	YSD 074	7.4	YSD 075	7.5	YSD 076	7.6	YSD 077	7.7	YSD 078	7.8	YSD 079	7.9	YSD 080	8.0	YSD 081	8.1	YSD 082	8.2	YSD 083	8.3	YSD 084	8.4	YSD 085	8.5	YSD 086	8.6	YSD 087	8.7	YSD 088	8.8	YSD 089	8.9	YSD 090	9.0	YSD 091	9.1	YSD 092	9.2	YSD 093	9.3	YSD 094	9.4	YSD 095	9.5	YSD 096	9.6	YSD 097	9.7	YSD 098	9.8	YSD 099	9.9	YSD 100	10.0	YSD 101	10.1	YSD 102	10.2	YSD 103	10.3	YSD 104	10.4	YSD 105	10.5	YSD 106	10.6	YSD 107	10.7	YSD 108	10.8	YSD 109	10.9	YSD 110	11.0	YSD 111	11.1	YSD 113	11.3	YSD 114	11.4	YSD 115	11.5	YSD 116	11.6	YSD 117	11.7	YSD 118	11.8	YSD 119	11.9	YSD 120	12.0	YSD 121	12.1	YSD 122	12.2	YSD 123	12.3	YSD 124	12.4	YSD 125	12.5	YSD 126	12.6	YSD 127	12.7	YSD 128	12.8	YSD 129	12.9	YSD 130	13.0	YSD 131	13.1	YSD 132	13.2	YSD 133	13.3	YSD 134	13.4	YSD 135	13.5	YSD 136	13.6	YSD 137	13.7	YSD 138	13.8	YSD 139	13.9	YSD 140	14.0	YSD 141	14.1	YSD 142	14.2	YSD 143	14.3	YSD 144	14.4	YSD 145	14.5	YSD 146	14.6	YSD 147	14.7	YSD 148	14.8	YSD 149	14.9	YSD 150	15.0	YSD 151	15.1	YSD 152	15.2	YSD 153	15.3	YSD 154	15.4	YSD 155	15.5	YSD 156	15.6	YSD 157	15.7	YSD 158	15.8	YSD 159	15.9	YSD 160	16.0	YSD 161	16.1	YSD 163	16.3	YSD 164	16.4	YSD 165	16.5	YSD 166	16.6	YSD 167	16.7	YSD 168	16.8	YSD 169	16.9	YSD 170	17.0	YSD 171	17.1	YSD 172	17.2	YSD 173	17.3	YSD 174	17.4	YSD 175	17.5	YSD 176	17.6	YSD 177	17.7	YSD 178	17.8	YSD 179	17.9	YSD 180	18.0	YSD 181	18.1	YSD 182	18.2	YSD 183	18.3	YSD 184	18.4	YSD 185	18.5	YSD 186	18.6	YSD 187	18.7	YSD 188	18.8	YSD 189	18.9	YSD 190	19.0	YSD 191	19.1	YSD 192	19.2	YSD 193	19.3	YSD 194	19.4	YSD 195	19.5	YSD 196	19.6	YSD 197	19.7	YSD 198	19.8	YSD 199	19.9	YSD 200	20.0								
YSD 068	6.8					YSD 069	6.9					YSD 070	7.0					YSD 071	7.1	YSD 072	7.2	YSD 073	7.3	YSD 074	7.4	YSD 075	7.5	YSD 076	7.6	YSD 077	7.7	YSD 078	7.8	YSD 079	7.9	YSD 080	8.0	YSD 081	8.1	YSD 082	8.2	YSD 083	8.3	YSD 084	8.4	YSD 085	8.5	YSD 086	8.6	YSD 087	8.7	YSD 088	8.8	YSD 089	8.9	YSD 090	9.0	YSD 091	9.1	YSD 092	9.2	YSD 093	9.3	YSD 094	9.4	YSD 095	9.5	YSD 096	9.6	YSD 097	9.7	YSD 098	9.8	YSD 099	9.9	YSD 100	10.0	YSD 101	10.1	YSD 102	10.2	YSD 103	10.3	YSD 104	10.4	YSD 105	10.5	YSD 106	10.6	YSD 107	10.7	YSD 108	10.8	YSD 109	10.9	YSD 110	11.0	YSD 111	11.1	YSD 113	11.3	YSD 114	11.4	YSD 115	11.5	YSD 116	11.6	YSD 117	11.7	YSD 118	11.8	YSD 119	11.9	YSD 120	12.0	YSD 121	12.1	YSD 122	12.2	YSD 123	12.3	YSD 124	12.4	YSD 125	12.5	YSD 126	12.6	YSD 127	12.7	YSD 128	12.8	YSD 129	12.9	YSD 130	13.0	YSD 131	13.1	YSD 132	13.2	YSD 133	13.3	YSD 134	13.4	YSD 135	13.5	YSD 136	13.6	YSD 137	13.7	YSD 138	13.8	YSD 139	13.9	YSD 140	14.0	YSD 141	14.1	YSD 142	14.2	YSD 143	14.3	YSD 144	14.4	YSD 145	14.5	YSD 146	14.6	YSD 147	14.7	YSD 148	14.8	YSD 149	14.9	YSD 150	15.0	YSD 151	15.1	YSD 152	15.2	YSD 153	15.3	YSD 154	15.4	YSD 155	15.5	YSD 156	15.6	YSD 157	15.7	YSD 158	15.8	YSD 159	15.9	YSD 160	16.0	YSD 161	16.1	YSD 163	16.3	YSD 164	16.4	YSD 165	16.5	YSD 166	16.6	YSD 167	16.7	YSD 168	16.8	YSD 169	16.9	YSD 170	17.0	YSD 171	17.1	YSD 172	17.2	YSD 173	17.3	YSD 174	17.4	YSD 175	17.5	YSD 176	17.6	YSD 177	17.7	YSD 178	17.8	YSD 179	17.9	YSD 180	18.0	YSD 181	18.1	YSD 182	18.2	YSD 183	18.3	YSD 184	18.4	YSD 185	18.5	YSD 186	18.6	YSD 187	18.7	YSD 188	18.8	YSD 189	18.9	YSD 190	19.0	YSD 191	19.1	YSD 192	19.2	YSD 193	19.3	YSD 194	19.4	YSD 195	19.5	YSD 196	19.6	YSD 197	19.7	YSD 198	19.8	YSD 199	19.9	YSD 200	20.0										
YSD 069	6.9					YSD 070	7.0					YSD 071	7.1					YSD 072	7.2	YSD 073	7.3	YSD 074	7.4	YSD 075	7.5	YSD 076	7.6	YSD 077	7.7	YSD 078	7.8	YSD 079	7.9	YSD 080	8.0	YSD 081	8.1	YSD 082	8.2	YSD 083	8.3	YSD 084	8.4	YSD 085	8.5	YSD 086	8.6	YSD 087	8.7	YSD 088	8.8	YSD 089	8.9	YSD 090	9.0	YSD 091	9.1	YSD 092	9.2	YSD 093	9.3	YSD 094	9.4	YSD 095	9.5	YSD 096	9.6	YSD 097	9.7	YSD 098	9.8	YSD 099	9.9	YSD 100	10.0	YSD 101	10.1	YSD 102	10.2	YSD 103	10.3	YSD 104	10.4	YSD 105	10.5	YSD 106	10.6	YSD 107	10.7	YSD 108	10.8	YSD 109	10.9	YSD 110	11.0	YSD 111	11.1	YSD 113	11.3	YSD 114	11.4	YSD 115	11.5	YSD 116	11.6	YSD 117	11.7	YSD 118	11.8	YSD 119	11.9	YSD 120	12.0	YSD 121	12.1	YSD 122	12.2	YSD 123	12.3	YSD 124	12.4	YSD 125	12.5	YSD 126	12.6	YSD 127	12.7	YSD 128	12.8	YSD 129	12.9	YSD 130	13.0	YSD 131	13.1	YSD 132	13.2	YSD 133	13.3	YSD 134	13.4	YSD 135	13.5	YSD 136	13.6	YSD 137	13.7	YSD 138	13.8	YSD 139	13.9	YSD 140	14.0	YSD 141	14.1	YSD 142	14.2	YSD 143	14.3	YSD 144	14.4	YSD 145	14.5	YSD 146	14.6	YSD 147	14.7	YSD 148	14.8	YSD 149	14.9	YSD 150	15.0	YSD 151	15.1	YSD 152	15.2	YSD 153	15.3	YSD 154	15.4	YSD 155	15.5	YSD 156	15.6	YSD 157	15.7	YSD 158	15.8	YSD 159	15.9	YSD 160	16.0	YSD 161	16.1	YSD 163	16.3	YSD 164	16.4	YSD 165	16.5	YSD 166	16.6	YSD 167	16.7	YSD 168	16.8	YSD 169	16.9	YSD 170	17.0	YSD 171	17.1	YSD 172	17.2	YSD 173	17.3	YSD 174	17.4	YSD 175	17.5	YSD 176	17.6	YSD 177	17.7	YSD 178	17.8	YSD 179	17.9	YSD 180	18.0	YSD 181	18.1	YSD 182	18.2	YSD 183	18.3	YSD 184	18.4	YSD 185	18.5	YSD 186	18.6	YSD 187	18.7	YSD 188	18.8	YSD 189	18.9	YSD 190	19.0	YSD 191	19.1	YSD 192	19.2	YSD 193	19.3	YSD 194	19.4	YSD 195	19.5	YSD 196	19.6	YSD 197	19.7	YSD 198	19.8	YSD 199	19.9	YSD 200	20.0												
YSD 070	7.0					YSD 071	7.1					YSD 072	7.2					YSD 073	7.3	YSD 074	7.4	YSD 075	7.5	YSD 076	7.6	YSD 077	7.7	YSD 078	7.8	YSD 079	7.9	YSD 080	8.0	YSD 081	8.1	YSD 082	8.2	YSD 083	8.3	YSD 084	8.4	YSD 085	8.5	YSD 086	8.6	YSD 087	8.7	YSD 088	8.8	YSD 089	8.9	YSD 090	9.0	YSD 091	9.1	YSD 092	9.2	YSD 093	9.3	YSD 094	9.4	YSD 095	9.5	YSD 096	9.6	YSD 097	9.7	YSD 098	9.8	YSD 099	9.9	YSD 100	10.0	YSD 101	10.1	YSD 102	10.2	YSD 103	10.3	YSD 104	10.4	YSD 105	10.5	YSD 106	10.6	YSD 107	10.7	YSD 108	10.8	YSD 109	10.9	YSD 110	11.0	YSD 111	11.1	YSD 113	11.3	YSD 114	11.4	YSD 115	11.5	YSD 116	11.6	YSD 117	11.7	YSD 118	11.8	YSD 119	11.9	YSD 120	12.0	YSD 121	12.1	YSD 122	12.2	YSD 123	12.3	YSD 124	12.4	YSD 125	12.5	YSD 126	12.6	YSD 127	12.7	YSD 128	12.8	YSD 129	12.9	YSD 130	13.0	YSD 131	13.1	YSD 132	13.2	YSD 133	13.3	YSD 134	13.4	YSD 135	13.5	YSD 136	13.6	YSD 137	13.7	YSD 138	13.8	YSD 139	13.9	YSD 140	14.0	YSD 141	14.1	YSD 142	14.2	YSD 143	14.3	YSD 144	14.4	YSD 145	14.5	YSD 146	14.6	YSD 147	14.7	YSD 148	14.8	YSD 149	14.9	YSD 150	15.0	YSD 151	15.1	YSD 152	15.2	YSD 153	15.3	YSD 154	15.4	YSD 155	15.5	YSD 156	15.6	YSD 157	15.7	YSD 158	15.8	YSD 159	15.9	YSD 160	16.0	YSD 161	16.1	YSD 163	16.3	YSD 164	16.4	YSD 165	16.5	YSD 166	16.6	YSD 167	16.7	YSD 168	16.8	YSD 169	16.9	YSD 170	17.0	YSD 171	17.1	YSD 172	17.2	YSD 173	17.3	YSD 174	17.4	YSD 175	17.5	YSD 176	17.6	YSD 177	17.7	YSD 178	17.8	YSD 179	17.9	YSD 180	18.0	YSD 181	18.1	YSD 182	18.2	YSD 183	18.3	YSD 184	18.4	YSD 185	18.5	YSD 186	18.6	YSD 187	18.7	YSD 188	18.8	YSD 189	18.9	YSD 190	19.0	YSD 191	19.1	YSD 192	19.2	YSD 193	19.3	YSD 194	19.4	YSD 195	19.5	YSD 196	19.6	YSD 197	19.7	YSD 198	19.8	YSD 199	19.9	YSD 200	20.0														
YSD 071	7.1					YSD 072	7.2					YSD 073	7.3					YSD 074	7.4	YSD 075	7.5	YSD 076	7.6	YSD 077	7.7	YSD 078	7.8	YSD 079	7.9	YSD 080	8.0	YSD 081	8.1	YSD 082	8.2	YSD 083	8.3	YSD 084	8.4	YSD 085	8.5	YSD 086	8.6	YSD 087	8.7	YSD 088	8.8	YSD 089	8.9	YSD 090	9.0	YSD 091	9.1	YSD 092	9.2	YSD 093	9.3	YSD 094	9.4	YSD 095	9.5	YSD 096	9.6	YSD 097	9.7	YSD 098	9.8	YSD 099	9.9	YSD 100	10.0	YSD 101	10.1	YSD 102	10.2	YSD 103	10.3	YSD 104	10.4	YSD 105	10.5	YSD 106	10.6	YSD 107	10.7	YSD 108	10.8	YSD 109	10.9	YSD 110	11.0	YSD 111	11.1	YSD 113	11.3	YSD 114	11.4	YSD 115	11.5	YSD 116	11.6	YSD 117	11.7	YSD 118	11.8	YSD 119	11.9	YSD 120	12.0	YSD 121	12.1	YSD 122	12.2	YSD 123	12.3	YSD 124	12.4	YSD 125	12.5	YSD 126	12.6	YSD 127	12.7	YSD 128	12.8	YSD 129	12.9	YSD 130	13.0	YSD 131	13.1	YSD 132	13.2	YSD 133	13.3	YSD 134	13.4	YSD 135	13.5	YSD 136	13.6	YSD 137	13.7	YSD 138	13.8	YSD 139	13.9	YSD 140	14.0	YSD 141	14.1	YSD 142	14.2	YSD 143	14.3	YSD 144	14.4	YSD 145	14.5	YSD 146	14.6	YSD 147	14.7	YSD 148	14.8	YSD 149	14.9	YSD 150	15.0	YSD 151	15.1	YSD 152	15.2	YSD 153	15.3	YSD 154	15.4	YSD 155	15.5	YSD 156	15.6	YSD 157	15.7	YSD 158	15.8	YSD 159	15.9	YSD 160	16.0	YSD 161	16.1	YSD 163	16.3	YSD 164	16.4	YSD 165	16.5	YSD 166	16.6	YSD 167	16.7	YSD 168	16.8	YSD 169	16.9	YSD 170	17.0	YSD 171	17.1	YSD 172	17.2	YSD 173	17.3	YSD 174	17.4	YSD 175	17.5	YSD 176	17.6	YSD 177	17.7	YSD 178	17.8	YSD 179	17.9	YSD 180	18.0	YSD 181	18.1	YSD 182	18.2	YSD 183	18.3	YSD 184	18.4	YSD 185	18.5	YSD 186	18.6	YSD 187	18.7	YSD 188	18.8	YSD 189	18.9	YSD 190	19.0	YSD 191	19.1	YSD 192	19.2	YSD 193	19.3	YSD 194	19.4	YSD 195	19.5	YSD 196	19.6	YSD 197	19.7	YSD 198	19.8	YSD 199	19.9	YSD 200	20.0																
YSD 072	7.2	YSD 073	7.3	YSD 074	7.4	YSD 075	7.5	YSD 076	7.6	YSD 077	7.7	YSD 078	7.8	YSD 079	7.9	YSD 080	8.0	YSD 081	8.1	YSD 082	8.2	YSD 083	8.3	YSD 084	8.4	YSD 085	8.5	YSD 086	8.6	YSD 087	8.7	YSD 088	8.8	YSD 089	8.9	YSD 090	9.0	YSD 091	9.1	YSD 092	9.2	YSD 093	9.3	YSD 094	9.4	YSD 095	9.5	YSD 096	9.6	YSD 097	9.7	YSD 098	9.8	YSD 099	9.9	YSD 100	10.0	YSD 101	10.1	YSD 102	10.2	YSD 103	10.3	YSD 104	10.4	YSD 105	10.5	YSD 106	10.6	YSD 107	10.7	YSD 108	10.8	YSD 109	10.9	YSD 110	11.0	YSD 111	11.1	YSD 113	11.3	YSD 114	11.4	YSD 115	11.5	YSD 116	11.6	YSD 117	11.7	YSD 118	11.8	YSD 119	11.9	YSD 120	12.0	YSD 121	12.1	YSD 122	12.2	YSD 123	12.3	YSD 124	12.4	YSD 125	12.5	YSD 126	12.6	YSD 127	12.7	YSD 128	12.8	YSD 129	12.9	YSD 130	13.0	YSD 131	13.1	YSD 132	13.2	YSD 133	13.3	YSD 134	13.4	YSD 135	13.5	YSD 136	13.6	YSD 137	13.7	YSD 138	13.8	YSD 139	13.9	YSD 140	14.0	YSD 141	14.1	YSD 142	14.2	YSD 143	14.3	YSD 144	14.4	YSD 145	14.5	YSD 146	14.6	YSD 147	14.7	YSD 148	14.8	YSD 149	14.9	YSD 150	15.0	YSD 151	15.1	YSD 152	15.2	YSD 153	15.3	YSD 154	15.4	YSD 155	15.5	YSD 156	15.6	YSD 157	15.7	YSD 158	15.8	YSD 159	15.9	YSD 160	16.0	YSD 161	16.1	YSD 163	16.3	YSD 164	16.4	YSD 165	16.5	YSD 166	16.6	YSD 167	16.7	YSD 168	16.8	YSD 169	16.9	YSD 170	17.0	YSD 171	17.1	YSD 172	17.2	YSD 173	17.3	YSD 174	17.4	YSD 175	17.5	YSD 176	17.6	YSD 177	17.7	YSD 178	17.8	YSD 179	17.9	YSD 180	18.0	YSD 181	18.1	YSD 182	18.2	YSD 183	18.3	YSD 184	18.4	YSD 185	18.5	YSD 186	18.6	YSD 187	18.7	YSD 188	18.8	YSD 189	18.9	YSD 190	19.0	YSD 191	19.1	YSD 192	19.2	YSD 193	19.3	YSD 194	19.4	YSD 195	19.5	YSD 196	19.6	YSD 197	19.7	YSD 198	19.8	YSD 199	19.9	YSD 200	20.0																														
YSD 073	7.3	YSD 074	7.4	YSD 075	7.5	YSD 076	7.6	YSD 077	7.7	YSD 078	7.8	YSD 079	7.9	YSD 080	8.0	YSD 081	8.1	YSD 082	8.2	YSD 083	8.3	YSD 084	8.4	YSD 085	8.5	YSD 086	8.6	YSD 087	8.7	YSD 088	8.8	YSD 089	8.9	YSD 090	9.0	YSD 091	9.1	YSD 092	9.2	YSD 093	9.3	YSD 094	9.4	YSD 095	9.5	YSD 096	9.6	YSD 097	9.7	YSD 098	9.8	YSD 099	9.9	YSD 100	10.0	YSD 101	10.1	YSD 102	10.2	YSD 103	10.3	YSD 104	10.4	YSD 105	10.5	YSD 106	10.6	YSD 107	10.7	YSD 108	10.8	YSD 109	10.9	YSD 110	11.0	YSD 111	11.1	YSD 113	11.3	YSD 114	11.4	YSD 115	11.5	YSD 116	11.6	YSD 117	11.7	YSD 118	11.8	YSD 119	11.9	YSD 120	12.0	YSD 121	12.1	YSD 122	12.2	YSD 123	12.3	YSD 124	12.4	YSD 125	12.5	YSD 126	12.6	YSD 127	12.7	YSD 128	12.8	YSD 129	12.9	YSD 130	13.0	YSD 131	13.1	YSD 132	13.2	YSD 133	13.3	YSD 134	13.4	YSD 135	13.5	YSD 136	13.6	YSD 137	13.7	YSD 138	13.8	YSD 139	13.9	YSD 140	14.0	YSD 141	14.1	YSD 142	14.2	YSD 143	14.3	YSD 144	14.4	YSD 145	14.5	YSD 146	14.6	YSD 147	14.7	YSD 148	14.8	YSD 149	14.9	YSD 150	15.0	YSD 151	15.1	YSD 152	15.2	YSD 153	15.3	YSD 154	15.4	YSD 155	15.5	YSD 156	15.6	YSD 157	15.7	YSD 158	15.8	YSD 159	15.9	YSD 160	16.0	YSD 161	16.1	YSD 163	16.3	YSD 164	16.4	YSD 165	16.5	YSD 166	16.6	YSD 167	16.7	YSD 168	16.8	YSD 169	16.9	YSD 170	17.0	YSD 171	17.1	YSD 172	17.2	YSD 173	17.3	YSD 174	17.4	YSD 175	17.5	YSD 176	17.6	YSD 177	17.7	YSD 178	17.8	YSD 179	17.9	YSD 180	18.0	YSD 181	18.1	YSD 182	18.2	YSD 183	18.3	YSD 184	18.4	YSD 185	18.5	YSD 186	18.6	YSD 187	18.7	YSD 188	18.8	YSD 189	18.9	YSD 190	19.0	YSD 191	19.1	YSD 192	19.2	YSD 193	19.3	YSD 194	19.4	YSD 195	19.5	YSD 196	19.6	YSD 197	19.7	YSD 198	19.8	YSD 199	19.9	YSD 200	20.0																																
YSD 074	7.4	YSD 075	7.5	YSD 076	7.6	YSD 077	7.7	YSD 078	7.8	YSD 079	7.9	YSD 080	8.0	YSD 081	8.1	YSD 082	8.2	YSD 083	8.3	YSD 084	8.4	YSD 085	8.5	YSD 086	8.6	YSD 087	8.7	YSD 088	8.8	YSD 089	8.9	YSD 090	9.0	YSD 091	9.1	YSD 092	9.2	YSD 093	9.3	YSD 094	9.4	YSD 095	9.5	YSD 096	9.6	YSD 097	9.7	YSD 098	9.8	YSD 099	9.9	YSD 100	10.0	YSD 101	10.1	YSD 102	10.2	YSD 103	10.3	YSD 104	10.4	YSD 105	10.5	YSD 106	10.6	YSD 107	10.7	YSD 108	10.8	YSD 109	10.9	YSD 110	11.0	YSD 111	11.1	YSD 113	11.3	YSD 114	11.4	YSD 115	11.5	YSD 116	11.6	YSD 117	11.7	YSD 118	11.8	YSD 119	11.9	YSD 120	12.0	YSD 121	12.1	YSD 122	12.2	YSD 123	12.3	YSD 124	12.4	YSD 125	12.5	YSD 126	12.6	YSD 127	12.7	YSD 128	12.8	YSD 129	12.9	YSD 130	13.0	YSD 131	13.1	YSD 132	13.2	YSD 133	13.3	YSD 134	13.4	YSD 135	13.5	YSD 136	13.6	YSD 137	13.7	YSD 138	13.8	YSD 139	13.9	YSD 140	14.0	YSD 141	14.1	YSD 142	14.2	YSD 143	14.3	YSD 144	14.4	YSD 145	14.5	YSD 146	14.6	YSD 147	14.7	YSD 148	14.8	YSD 149	14.9	YSD 150	15.0	YSD 151	15.1	YSD 152	15.2	YSD 153	15.3	YSD 154	15.4	YSD 155	15.5	YSD 156	15.6	YSD 157	15.7	YSD 158	15.8	YSD 159	15.9	YSD 160	16.0	YSD 161	16.1	YSD 163	16.3	YSD 164	16.4	YSD 165	16.5	YSD 166	16.6	YSD 167	16.7	YSD 168	16.8	YSD 169	16.9	YSD 170	17.0	YSD 171	17.1	YSD 172	17.2	YSD 173	17.3	YSD 174	17.4	YSD 175	17.5	YSD 176	17.6	YSD 177	17.7	YSD 178	17.8	YSD 179	17.9	YSD 180	18.0	YSD 181	18.1	YSD 182	18.2	YSD 183	18.3	YSD 184	18.4	YSD 185	18.5	YSD 186	18.6	YSD 187	18.7	YSD 188	18.8	YSD 189	18.9	YSD 190	19.0	YSD 191	19.1	YSD 192	19.2	YSD 193	19.3	YSD 194	19.4	YSD 195	19.5	YSD 196	19.6	YSD 197	19.7	YSD 198	19.8	YSD 199	19.9	YSD 200	20.0																																		
YSD 075	7.5	YSD 076	7.6	YSD 077	7.7	YSD 078	7.8	YSD 079	7.9	YSD 080	8.0	YSD 081	8.1	YSD 082	8.2	YSD 083	8.3	YSD 084	8.4	YSD 085	8.5	YSD 086	8.6	YSD 087	8.7	YSD 088	8.8	YSD 089	8.9	YSD 090	9.0	YSD 091	9.1	YSD 092	9.2	YSD 093	9.3	YSD 094	9.4	YSD 095	9.5	YSD 096	9.6	YSD 097	9.7	YSD 098	9.8	YSD 099	9.9	YSD 100	10.0	YSD 101	10.1	YSD 102	10.2	YSD 103	10.3	YSD 104	10.4	YSD 105	10.5	YSD 106	10.6	YSD 107	10.7	YSD 108	10.8	YSD 109	10.9	YSD 110	11.0	YSD 111	11.1	YSD 113	11.3	YSD 114	11.4	YSD 115	11.5	YSD 116	11.6	YSD 117	11.7	YSD 118	11.8	YSD 119	11.9	YSD 120	12.0	YSD 121	12.1	YSD 122	12.2	YSD 123	12.3	YSD 124	12.4	YSD 125	12.5	YSD 126	12.6	YSD 127	12.7	YSD 128	12.8	YSD 129	12.9	YSD 130	13.0	YSD 131	13.1	YSD 132	13.2	YSD 133	13.3	YSD 134	13.4	YSD 135	13.5	YSD 136	13.6	YSD 137	13.7	YSD 138	13.8	YSD 139	13.9	YSD 140	14.0	YSD 141	14.1	YSD 142	14.2	YSD 143	14.3	YSD 144	14.4	YSD 145	14.5	YSD 146	14.6	YSD 147	14.7	YSD 148	14.8	YSD 149	14.9	YSD 150	15.0	YSD 151	15.1	YSD 152	15.2	YSD 153	15.3	YSD 154	15.4	YSD 155	15.5	YSD 156	15.6	YSD 157	15.7	YSD 158	15.8	YSD 159	15.9	YSD 160	16.0	YSD 161	16.1	YSD 163	16.3	YSD 164	16.4	YSD 165	16.5	YSD 166	16.6	YSD 167	16.7	YSD 168	16.8	YSD 169	16.9	YSD 170	17.0	YSD 171	17.1	YSD 172	17.2	YSD 173	17.3	YSD 174	17.4	YSD 175	17.5	YSD 176	17.6	YSD 177	17.7	YSD 178	17.8	YSD 179	17.9	YSD 180	18.0	YSD 181	18.1	YSD 182	18.2	YSD 183	18.3	YSD 184	18.4	YSD 185	18.5	YSD 186	18.6	YSD 187	18.7	YSD 188	18.8	YSD 189	18.9	YSD 190	19.0	YSD 191	19.1	YSD 192	19.2	YSD 193	19.3	YSD 194	19.4	YSD 195	19.5	YSD 196	19.6	YSD 197	19.7	YSD 198	19.8	YSD 199	19.9	YSD 200	20.0																																				
YSD 076	7.6	YSD 077	7.7	YSD 078	7.8	YSD 079	7.9	YSD 080	8.0	YSD 081	8.1	YSD 082	8.2	YSD 083	8.3	YSD 084	8.4	YSD 085	8.5	YSD 086	8.6	YSD 087	8.7	YSD 088	8.8	YSD 089	8.9	YSD 090	9.0	YSD 091	9.1	YSD 092	9.2	YSD 093	9.3	YSD 094	9.4	YSD 095	9.5	YSD 096	9.6	YSD 097	9.7	YSD 098	9.8	YSD 099	9.9	YSD 100	10.0	YSD 101	10.1	YSD 102	10.2	YSD 103	10.3	YSD 104	10.4	YSD 105	10.5	YSD 106	10.6	YSD 107	10.7	YSD 108	10.8	YSD 109	10.9	YSD 110	11.0	YSD 111	11.1	YSD 113	11.3	YSD 114	11.4	YSD 115	11.5	YSD 116	11.6	YSD 117	11.7	YSD 118	11.8	YSD 119	11.9	YSD 120	12.0	YSD 121	12.1	YSD 122	12.2	YSD 123	12.3	YSD 124	12.4	YSD 125	12.5	YSD 126	12.6	YSD 127	12.7	YSD 128	12.8	YSD 129	12.9	YSD 130	13.0	YSD 131	13.1	YSD 132	13.2	YSD 133	13.3	YSD 134	13.4	YSD 135	13.5	YSD 136	13.6	YSD 137	13.7	YSD 138	13.8	YSD 139	13.9	YSD 140	14.0	YSD 141	14.1	YSD 142	14.2	YSD 143	14.3	YSD 144	14.4	YSD 145	14.5	YSD 146	14.6	YSD 147	14.7	YSD 148	14.8	YSD 149	14.9	YSD 150	15.0	YSD 151	15.1	YSD 152	15.2	YSD 153	15.3	YSD 154	15.4	YSD 155	15.5	YSD 156	15.6	YSD 157	15.7	YSD 158	15.8	YSD 159	15.9	YSD 160	16.0	YSD 161	16.1	YSD 163	16.3	YSD 164	16.4	YSD 165	16.5	YSD 166	16.6	YSD 167	16.7	YSD 168	16.8	YSD 169	16.9	YSD 170	17.0	YSD 171	17.1	YSD 172	17.2	YSD 173	17.3	YSD 174	17.4	YSD 175	17.5	YSD 176	17.6	YSD 177	17.7	YSD 178	17.8	YSD 179	17.9	YSD 180	18.0	YSD 181	18.1	YSD 182	18.2	YSD 183	18.3	YSD 184	18.4	YSD 185	18.5	YSD 186	18.6	YSD 187	18.7	YSD 188	18.8	YSD 189	18.9	YSD 190	19.0	YSD 191	19.1	YSD 192	19.2	YSD 193	19.3	YSD 194	19.4	YSD 195	19.5	YSD 196	19.6	YSD 197	19.7	YSD 198	19.8	YSD 199	19.9	YSD 200	20.0																																						
YSD 077	7.7	YSD 078	7.8	YSD 079	7.9	YSD 080	8.0	YSD 081	8.1	YSD 082	8.2	YSD 083	8.3	YSD 084	8.4	YSD 085	8.5	YSD 086	8.6	YSD 087	8.7	YSD 088	8.8	YSD 089	8.9	YSD 090	9.0	YSD 091	9.1	YSD 092	9.2	YSD 093	9.3	YSD 094	9.4	YSD 095	9.5	YSD 096	9.6	YSD 097	9.7	YSD 098	9.8	YSD 099	9.9	YSD 100	10.0	YSD 101	10.1	YSD 102	10.2	YSD 103	10.3	YSD 104	10.4	YSD 105	10.5	YSD 106	10.6	YSD 107	10.7	YSD 108	10.8	YSD 109	10.9	YSD 110	11.0	YSD 111	11.1	YSD 113	11.3	YSD 114	11.4	YSD 115	11.5	YSD 116	11.6	YSD 117	11.7	YSD 118	11.8	YSD 119	11.9	YSD 120	12.0	YSD 121	12.1	YSD 122	12.2	YSD 123	12.3	YSD 124	12.4	YSD 125	12.5	YSD 126	12.6	YSD 127	12.7	YSD 128	12.8	YSD 129	12.9	YSD 130	13.0	YSD 131	13.1	YSD 132	13.2	YSD 133	13.3	YSD 134	13.4	YSD 135	13.5	YSD 136	13.6	YSD 137	13.7	YSD 138	13.8	YSD 139	13.9	YSD 140	14.0	YSD 141	14.1	YSD 142	14.2	YSD 143	14.3	YSD 144	14.4	YSD 145	14.5	YSD 146	14.6	YSD 147	14.7	YSD 148	14.8	YSD 149	14.9	YSD 150	15.0	YSD 151	15.1	YSD 152	15.2	YSD 153	15.3	YSD 154	15.4	YSD 155	15.5	YSD 156	15.6	YSD 157	15.7	YSD 158	15.8	YSD 159	15.9	YSD 160	16.0	YSD 161	16.1	YSD 163	16.3	YSD 164	16.4	YSD 165	16.5	YSD 166	16.6	YSD 167	16.7	YSD 168	16.8	YSD 169	16.9	YSD 170	17.0	YSD 171	17.1	YSD 172	17.2	YSD 173	17.3	YSD 174	17.4	YSD 175	17.5	YSD 176	17.6	YSD 177	17.7	YSD 178	17.8	YSD 179	17.9	YSD 180	18.0	YSD 181	18.1	YSD 182	18.2	YSD 183	18.3	YSD 184	18.4	YSD 185	18.5	YSD 186	18.6	YSD 187	18.7	YSD 188	18.8	YSD 189	18.9	YSD 190	19.0	YSD 191	19.1	YSD 192	19.2	YSD 193	19.3	YSD 194	19.4	YSD 195	19.5	YSD 196	19.6	YSD 197	19.7	YSD 198	19.8	YSD 199	19.9	YSD 200	20.0																																								
YSD 078	7.8	YSD 079	7.9	YSD 080	8.0	YSD 081	8.1	YSD 082	8.2	YSD 083	8.3	YSD 084	8.4	YSD 085	8.5	YSD 086	8.6	YSD 087	8.7	YSD 088	8.8	YSD 089	8.9	YSD 090	9.0	YSD 091	9.1	YSD 092	9.2	YSD 093	9.3	YSD 094	9.4	YSD 095	9.5	YSD 096	9.6	YSD 097	9.7	YSD 098	9.8	YSD 099	9.9	YSD 100	10.0	YSD 101	10.1	YSD 102	10.2	YSD 103	10.3	YSD 104	10.4	YSD 105	10.5	YSD 106	10.6	YSD 107	10.7	YSD 108	10.8	YSD 109	10.9	YSD 110	11.0	YSD 111	11.1	YSD 113	11.3	YSD 114	11.4	YSD 115	11.5	YSD 116	11.6	YSD 117	11.7	YSD 118	11.8	YSD 119	11.9	YSD 120	12.0	YSD 121	12.1	YSD 122	12.2	YSD 123	12.3	YSD 124	12.4	YSD 125	12.5	YSD 126	12.6	YSD 127	12.7	YSD 128	12.8	YSD 129	12.9	YSD 130	13.0	YSD 131	13.1	YSD 132	13.2	YSD 133	13.3	YSD 134	13.4	YSD 135	13.5	YSD 136	13.6	YSD 137	13.7	YSD 138	13.8	YSD 139	13.9	YSD 140	14.0	YSD 141	14.1	YSD 142	14.2	YSD 143	14.3	YSD 144	14.4	YSD 145	14.5	YSD 146	14.6	YSD 147	14.7	YSD 148	14.8	YSD 149	14.9	YSD 150	15.0	YSD 151	15.1	YSD 152	15.2	YSD 153	15.3	YSD 154	15.4	YSD 155	15.5	YSD 156	15.6	YSD 157	15.7	YSD 158	15.8	YSD 159	15.9	YSD 160	16.0	YSD 161	16.1	YSD 163	16.3	YSD 164	16.4	YSD 165	16.5	YSD 166	16.6	YSD 167	16.7	YSD 168	16.8	YSD 169	16.9	YSD 170	17.0	YSD 171	17.1	YSD 172	17.2	YSD 173	17.3	YSD 174	17.4	YSD 175	17.5	YSD 176	17.6	YSD 177	17.7	YSD 178	17.8	YSD 179	17.9	YSD 180	18.0	YSD 181	18.1	YSD 182	18.2	YSD 183	18.3	YSD 184	18.4	YSD 185	18.5	YSD 186	18.6	YSD 187	18.7	YSD 188	18.8	YSD 189	18.9	YSD 190	19.0	YSD 191	19.1	YSD 192	19.2	YSD 193	19.3	YSD 194	19.4	YSD 195	19.5	YSD 196	19.6	YSD 197	19.7	YSD 198	19.8	YSD 199	19.9	YSD 200	20.0																																										
YSD 079	7.9	YSD 080	8.0	YSD 081	8.1	YSD 082	8.2	YSD 083	8.3	YSD 084	8.4	YSD 085	8.5	YSD 086	8.6	YSD 087	8.7	YSD 088	8.8	YSD 089	8.9	YSD 090	9.0	YSD 091	9.1	YSD 092	9.2	YSD 093	9.3	YSD 094	9.4	YSD 095	9.5	YSD 096	9.6	YSD 097	9.7	YSD 098	9.8	YSD 099	9.9	YSD 100	10.0	YSD 101	10.1	YSD 102	10.2	YSD 103	10.3	YSD 104	10.4	YSD 105	10.5	YSD 106	10.6	YSD 107	10.7	YSD 108	10.8	YSD 109	10.9	YSD 110	11.0	YSD 111	11.1	YSD 113	11.3	YSD 114	11.4	YSD 115	11.5	YSD 116	11.6	YSD 117	11.7	YSD 118	11.8	YSD 119	11.9	YSD 120	12.0	YSD 121	12.1	YSD 122	12.2	YSD 123	12.3	YSD 124	12.4	YSD 125	12.5	YSD 126	12.6	YSD 127	12.7	YSD 128	12.8	YSD 129	12.9	YSD 130	13.0	YSD 131	13.1	YSD 132	13.2	YSD 133	13.3	YSD 134	13.4	YSD 135	13.5	YSD 136	13.6	YSD 137	13.7	YSD 138	13.8	YSD 139	13.9	YSD 140	14.0	YSD 141	14.1	YSD 142	14.2	YSD 143	14.3	YSD 144	14.4	YSD 145	14.5	YSD 146	14.6	YSD 147	14.7	YSD 148	14.8	YSD 149	14.9	YSD 150	15.0	YSD 151	15.1	YSD 152	15.2	YSD 153	15.3	YSD 154	15.4	YSD 155	15.5	YSD 156	15.6	YSD 157	15.7	YSD 158	15.8	YSD 159	15.9	YSD 160	16.0	YSD 161	16.1	YSD 163	16.3	YSD 164	16.4	YSD 165	16.5	YSD 166	16.6	YSD 167	16.7	YSD 168	16.8	YSD 169	16.9	YSD 170	17.0	YSD 171	17.1	YSD 172	17.2	YSD 173	17.3	YSD 174	17.4	YSD 175	17.5	YSD 176	17.6	YSD 177	17.7	YSD 178	17.8	YSD 179	17.9	YSD 180	18.0	YSD 181	18.1	YSD 182	18.2	YSD 183	18.3	YSD 184	18.4	YSD 185	18.5	YSD 186	18.6	YSD 187	18.7	YSD 188	18.8	YSD 189	18.9	YSD 190	19.0	YSD 191	19.1	YSD 192	19.2	YSD 193	19.3	YSD 194	19.4	YSD 195	19.5	YSD 196	19.6	YSD 197	19.7	YSD 198	19.8	YSD 199	19.9	YSD 200	20.0																																												
YSD 080	8.0	YSD 081	8.1	YSD 082	8.2	YSD 083	8.3	YSD 084	8.4	YSD 085	8.5	YSD 086	8.6	YSD 087	8.7	YSD 088	8.8	YSD 089	8.9	YSD 090	9.0	YSD 091	9.1	YSD 092	9.2	YSD 093	9.3	YSD 094	9.4	YSD 095	9.5	YSD 096	9.6	YSD 097	9.7	YSD 098	9.8	YSD 099	9.9	YSD 100	10.0	YSD 101	10.1	YSD 102	10.2	YSD 103	10.3	YSD 104	10.4	YSD 105	10.5	YSD 106	10.6	YSD 107	10.7	YSD 108	10.8	YSD 109	10.9	YSD 110	11.0	YSD 111	11.1	YSD 113	11.3	YSD 114	11.4	YSD 115	11.5	YSD 116	11.6	YSD 117	11.7	YSD 118	11.8	YSD 119	11.9	YSD 120	12.0	YSD 121	12.1	YSD 122	12.2	YSD 123	12.3	YSD 124	12.4	YSD 125	12.5	YSD 126	12.6	YSD 127	12.7	YSD 128	12.8	YSD 129	12.9	YSD 130	13.0	YSD 131	13.1	YSD 132	13.2	YSD 133	13.3	YSD 134	13.4	YSD 135	13.5	YSD 136	13.6	YSD 137	13.7	YSD 138	13.8	YSD 139	13.9	YSD 140	14.0	YSD 141	14.1	YSD 142	14.2	YSD 143	14.3	YSD 144	14.4	YSD 145	14.5	YSD 146	14.6	YSD 147	14.7	YSD 148	14.8	YSD 149	14.9	YSD 150	15.0	YSD 151	15.1	YSD 152	15.2	YSD 153	15.3	YSD 154	15.4	YSD 155	15.5	YSD 156	15.6	YSD 157	15.7	YSD 158	15.8	YSD 159	15.9	YSD 160	16.0	YSD 161	16.1	YSD 163	16.3	YSD 164	16.4	YSD 165	16.5	YSD 166	16.6	YSD 167	16.7	YSD 168	16.8	YSD 169	16.9	YSD 170	17.0	YSD 171	17.1	YSD 172	17.2	YSD 173	17.3	YSD 174	17.4	YSD 175	17.5	YSD 176	17.6	YSD 177	17.7	YSD 178	17.8	YSD 179	17.9	YSD 180	18.0	YSD 181	18.1	YSD 182	18.2	YSD 183	18.3	YSD 184	18.4	YSD 185	18.5	YSD 186	18.6	YSD 187	18.7	YSD 188	18.8	YSD 189	18.9	YSD 190	19.0	YSD 191	19.1	YSD 192	19.2	YSD 193	19.3	YSD 194	19.4	YSD 195	19.5	YSD 196	19.6	YSD 197	19.7	YSD 198	19.8	YSD 199	19.9	YSD 200	20.0																																														
YSD 081	8.1	YSD 082	8.2	YSD 083	8.3	YSD 084	8.4	YSD 085	8.5	YSD 086	8.6	YSD 087	8.7	YSD 088	8.8	YSD 089	8.9	YSD 090	9.0	YSD 091	9.1	YSD 092	9.2	YSD 093	9.3	YSD 094	9.4	YSD 095	9.5	YSD 096	9.6	YSD 097	9.7	YSD 098	9.8	YSD 099	9.9	YSD 100	10.0	YSD 101	10.1	YSD 102	10.2	YSD 103	10.3	YSD 104	10.4	YSD 105	10.5	YSD 106	10.6	YSD 107	10.7	YSD 108	10.8	YSD 109	10.9	YSD 110	11.0	YSD 111	11.1	YSD 113	11.3	YSD 114	11.4	YSD 115	11.5	YSD 116	11.6	YSD 117	11.7	YSD 118	11.8	YSD 119	11.9	YSD 120	12.0	YSD 121	12.1	YSD 122	12.2	YSD 123	12.3	YSD 124	12.4	YSD 125	12.5	YSD 126	12.6	YSD 127	12.7	YSD 128	12.8	YSD 129	12.9	YSD 130	13.0	YSD 131	13.1	YSD 132	13.2	YSD 133	13.3	YSD 134	13.4	YSD 135	13.5	YSD 136	13.6	YSD 137	13.7	YSD 138	13.8	YSD 139	13.9	YSD 140	14.0	YSD 141	14.1	YSD 142	14.2	YSD 143	14.3	YSD 144	14.4	YSD 145	14.5	YSD 146	14.6	YSD 147	14.7	YSD 148	14.8	YSD 149	14.9	YSD 150	15.0	YSD 151	15.1	YSD 152	15.2	YSD 153	15.3	YSD 154	15.4	YSD 155	15.5	YSD 156	15.6	YSD 157	15.7	YSD 158	15.8	YSD 159	15.9	YSD 160	16.0	YSD 161	16.1	YSD 163	16.3	YSD 164	16.4	YSD 165	16.5	YSD 166	16.6	YSD 167	16.7	YSD 168	16.8	YSD 169	16.9	YSD 170	17.0	YSD 171	17.1	YSD 172	17.2	YSD 173	17.3	YSD 174	17.4	YSD 175	17.5	YSD 176	17.6	YSD 177	17.7	YSD 178	17.8	YSD 179	17.9	YSD 180	18.0	YSD 181	18.1	YSD 182	18.2	YSD 183	18.3	YSD 184	18.4	YSD 185	18.5	YSD 186	18.6	YSD 187	18.7	YSD 188	18.8	YSD 189	18.9	YSD 190	19.0	YSD 191	19.1	YSD 192	19.2	YSD 193	19.3	YSD 194	19.4	YSD 195	19.5	YSD 196	19.6	YSD 197	19.7	YSD 198	19.8	YSD 199	19.9	YSD 200	20.0																																																
YSD 082	8.2	YSD 083	8.3	YSD 084	8.4	YSD 085	8.5	YSD 086	8.6	YSD 087	8.7	YSD 088	8.8	YSD 089	8.9	YSD 090	9.0	YSD 091	9.1	YSD 092	9.2	YSD 093	9.3	YSD 094	9.4	YSD 095	9.5	YSD 096	9.6	YSD 097	9.7	YSD 098	9.8	YSD 099	9.9	YSD 100	10.0	YSD 101	10.1	YSD 102	10.2	YSD 103	10.3	YSD 104	10.4	YSD 105	10.5	YSD 106	10.6	YSD 107	10.7	YSD 108	10.8	YSD 109	10.9	YSD 110	11.0	YSD 111	11.1	YSD 113	11.3	YSD 114	11.4	YSD 115	11.5	YSD 116	11.6	YSD 117	11.7	YSD 118	11.8	YSD 119	11.9	YSD 120	12.0	YSD 121	12.1	YSD 122	12.2	YSD 123	12.3	YSD 124	12.4	YSD 125	12.5	YSD 126	12.6	YSD 127	12.7	YSD 128	12.8	YSD 129	12.9	YSD 130	13.0	YSD 131	13.1	YSD 132	13.2	YSD 133	13.3	YSD 134	13.4	YSD 135	13.5	YSD 136	13.6	YSD 137	13.7	YSD 138	13.8	YSD 139	13.9	YSD 140	14.0	YSD 141	14.1	YSD 142	14.2	YSD 143	14.3	YSD 144	14.4	YSD 145	14.5	YSD 146	14.6	YSD 147	14.7	YSD 148	14.8	YSD 149	14.9	YSD 150	15.0	YSD 151	15.1	YSD 152	15.2	YSD 153	15.3	YSD 154	15.4	YSD 155	15.5	YSD 156	15.6	YSD 157	15.7	YSD 158	15.8	YSD 159	15.9	YSD 160	16.0	YSD 161	16.1	YSD 163	16.3	YSD 164	16.4	YSD 165	16.5	YSD 166	16.6	YSD 167	16.7	YSD 168	16.8	YSD 169	16.9	YSD 170	17.0	YSD 171	17.1	YSD 172	17.2	YSD 173	17.3	YSD 174	17.4	YSD 175	17.5	YSD 176	17.6	YSD 177	17.7	YSD 178	17.8	YSD 179	17.9	YSD 180	18.0	YSD 181	18.1	YSD 182	18.2	YSD 183	18.3	YSD 184	18.4	YSD 185	18.5	YSD 186	18.6	YSD 187	18.7	YSD 188	18.8	YSD 189	18.9	YSD 190	19.0	YSD 191	19.1	YSD 192	19.2	YSD 193	19.3	YSD 194	19.4	YSD 195	19.5	YSD 196	19.6	YSD 197	19.7	YSD 198	19.8	YSD 199	19.9	YSD 200	20.0																																																		
YSD 083	8.3	YSD 084	8.4	YSD 085	8.5	YSD 086	8.6	YSD 087	8.7	YSD 088	8.8	YSD 089	8.9	YSD 090	9.0	YSD 091	9.1	YSD 092	9.2	YSD 093	9.3	YSD 094	9.4	YSD 095	9.5	YSD 096	9.6	YSD 097	9.7	YSD 098	9.8	YSD 099	9.9	YSD 100	10.0	YSD 101	10.1	YSD 102	10.2	YSD 103	10.3	YSD 104	10.4	YSD 105	10.5	YSD 106	10.6	YSD 107	10.7	YSD 108	10.8	YSD 109	10.9	YSD 110	11.0	YSD 111	11.1	YSD 113	11.3	YSD 114	11.4	YSD 115	11.5	YSD 116	11.6	YSD 117	11.7	YSD 118	11.8	YSD 119	11.9	YSD 120	12.0	YSD 121	12.1	YSD 122	12.2	YSD 123	12.3	YSD 124	12.4	YSD 125	12.5	YSD 126	12.6	YSD 127	12.7	YSD 128	12.8	YSD 129	12.9	YSD 130	13.0	YSD 131	13.1	YSD 132	13.2	YSD 133	13.3	YSD 134	13.4	YSD 135	13.5	YSD 136	13.6	YSD 137	13.7	YSD 138	13.8	YSD 139	13.9	YSD 140	14.0	YSD 141	14.1	YSD 142	14.2	YSD 143	14.3	YSD 144	14.4	YSD 145	14.5	YSD 146	14.6	YSD 147	14.7	YSD 148	14.8	YSD 149	14.9	YSD 150	15.0	YSD 151	15.1	YSD 152	15.2	YSD 153	15.3	YSD 154	15.4	YSD 155	15.5	YSD 156	15.6	YSD 157	15.7	YSD 158	15.8	YSD 159	15.9	YSD 160	16.0	YSD 161	16.1	YSD 163	16.3	YSD 164	16.4	YSD 165	16.5	YSD 166	16.6	YSD 167	16.7	YSD 168	16.8	YSD 169	16.9	YSD 170	17.0	YSD 171	17.1	YSD 172	17.2	YSD 173	17.3	YSD 174	17.4	YSD 175	17.5	YSD 176	17.6	YSD 177	17.7	YSD 178	17.8	YSD 179	17.9	YSD 180	18.0	YSD 181	18.1	YSD 182	18.2	YSD 183	18.3	YSD 184	18.4	YSD 185	18.5	YSD 186	18.6	YSD 187	18.7	YSD 188	18.8	YSD 189	18.9	YSD 190	19.0	YSD 191	19.1	YSD 192	19.2	YSD 193	19.3	YSD 194	19.4	YSD 195	19.5	YSD 196	19.6	YSD 197	19.7	YSD 198	19.8	YSD 199	19.9	YSD 200	20.0																																																				
YSD 084	8.4	YSD 085	8.5	YSD 086	8.6	YSD 087	8.7	YSD 088	8.8	YSD 089	8.9	YSD 090	9.0	YSD 091	9.1	YSD 092	9.2	YSD 093	9.3	YSD 094	9.4	YSD 095	9.5	YSD 096	9.6	YSD 097	9.7	YSD 098	9.8	YSD 099	9.9	YSD 100	10.0	YSD 101	10.1	YSD 102	10.2	YSD 103	10.3	YSD 104	10.4	YSD 105	10.5	YSD 106	10.6	YSD 107	10.7	YSD 108	10.8	YSD 109	10.9	YSD 110	11.0	YSD 111	11.1	YSD 113	11.3	YSD 114	11.4	YSD 115	11.5	YSD 116	11.6	YSD 117	11.7	YSD 118	11.8	YSD 119	11.9	YSD 120	12.0	YSD 121	12.1	YSD 122	12.2	YSD 123	12.3	YSD 124	12.4	YSD 125	12.5	YSD 126	12.6	YSD 127	12.7	YSD 128	12.8	YSD 129	12.9	YSD 130	13.0	YSD 131	13.1	YSD 132	13.2	YSD 133	13.3	YSD 134	13.4	YSD 135	13.5	YSD 136	13.6	YSD 137	13.7	YSD 138	13.8	YSD 139	13.9	YSD 140	14.0	YSD 141	14.1	YSD 142	14.2	YSD 143	14.3	YSD 144	14.4	YSD 145	14.5	YSD 146	14.6	YSD 147	14.7	YSD 148	14.8	YSD 149	14.9	YSD 150	15.0	YSD 151	15.1	YSD 152	15.2	YSD 153	15.3	YSD 154	15.4	YSD 155	15.5	YSD 156	15.6	YSD 157	15.7	YSD 158	15.8	YSD 159	15.9	YSD 160	16.0	YSD 161	16.1	YSD 163	16.3	YSD 164	16.4	YSD 165	16.5	YSD 166	16.6	YSD 167	16.7	YSD 168	16.8	YSD 169	16.9	YSD 170	17.0	YSD 171	17.1	YSD 172	17.2	YSD 173	17.3	YSD 174	17.4	YSD 175	17.5	YSD 176	17.6	YSD 177	17.7	YSD 178	17.8	YSD 179	17.9	YSD 180	18.0	YSD 181	18.1	YSD 182	18.2	YSD 183	18.3	YSD 184	18.4	YSD 185	18.5	YSD 186	18.6	YSD 187	18.7	YSD 188	18.8	YSD 189	18.9	YSD 190	19.0	YSD 191	19.1	YSD 192	19.2	YSD 193	19.3	YSD 194	19.4	YSD 195	19.5	YSD 196	19.6	YSD 197	19.7	YSD 198	19.8	YSD 199	19.9	YSD 200	20.0																																																						
YSD 085	8.5	YSD 086	8.6	YSD 087	8.7	YSD 088	8.8	YSD 089	8.9	YSD 090	9.0	YSD 091	9.1	YSD 092	9.2	YSD 093	9.3	YSD 094	9.4	YSD 095	9.5	YSD 096	9.6	YSD 097	9.7	YSD 098	9.8	YSD 099	9.9	YSD 100	10.0	YSD 101	10.1	YSD 102	10.2	YSD 103	10.3	YSD 104	10.4	YSD 105	10.5	YSD 106	10.6	YSD 107	10.7	YSD 108	10.8	YSD 109	10.9	YSD 110	11.0	YSD 111	11.1	YSD 113	11.3	YSD 114	11.4	YSD 115	11.5	YSD 116	11.6	YSD 117	11.7	YSD 118	11.8	YSD 119	11.9	YSD 120	12.0	YSD 121	12.1	YSD 122	12.2	YSD 123	12.3	YSD 124	12.4	YSD 125	12.5	YSD 126	12.6	YSD 127	12.7	YSD 128	12.8	YSD 129	12.9	YSD 130	13.0	YSD 131	13.1	YSD 132	13.2	YSD 133	13.3	YSD 134	13.4	YSD 135	13.5	YSD 136	13.6	YSD 137	13.7	YSD 138	13.8	YSD 139	13.9	YSD 140	14.0	YSD 141	14.1	YSD 142	14.2	YSD 143	14.3	YSD 144	14.4	YSD 145	14.5	YSD 146	14.6	YSD 147	14.7	YSD 148	14.8	YSD 149	14.9	YSD 150	15.0	YSD 151	15.1	YSD 152	15.2	YSD 153	15.3	YSD 154	15.4	YSD 155	15.5	YSD 156	15.6	YSD 157	15.7	YSD 158	15.8	YSD 159	15.9	YSD 160	16.0	YSD 161	16.1	YSD 163	16.3	YSD 164	16.4	YSD 165	16.5	YSD 166	16.6	YSD 167	16.7	YSD 168	16.8	YSD 169	16.9	YSD 170	17.0	YSD 171	17.1	YSD 172	17.2	YSD 173	17.3	YSD 174	17.4	YSD 175	17.5	YSD 176	17.6	YSD 177	17.7	YSD 178	17.8	YSD 179	17.9	YSD 180	18.0	YSD 181	18.1	YSD 182	18.2	YSD 183	18.3	YSD 184	18.4	YSD 185	18.5	YSD 186	18.6	YSD 187	18.7	YSD 188	18.8	YSD 189	18.9	YSD 190	19.0	YSD 191	19.1	YSD 192	19.2	YSD 193	19.3	YSD 194	19.4	YSD 195	19.5	YSD 196	19.6	YSD 197	19.7	YSD 198	19.8	YSD 199	19.9	YSD 200	20.0																																																								
YSD 086	8.6	YSD 087	8.7	YSD 088	8.8	YSD 089	8.9	YSD 090	9.0	YSD 091	9.1	YSD 092	9.2	YSD 093	9.3	YSD 094	9.4	YSD 095	9.5	YSD 096	9.6	YSD 097	9.7	YSD 098	9.8	YSD 099	9.9	YSD 100	10.0	YSD 101	10.1	YSD 102	10.2	YSD 103	10.3	YSD 104	10.4	YSD 105	10.5	YSD 106	10.6	YSD 107	10.7	YSD 108	10.8	YSD 109	10.9	YSD 110	11.0	YSD 111	11.1	YSD 113	11.3	YSD 114	11.4	YSD 115	11.5	YSD 116	11.6	YSD 117	11.7	YSD 118	11.8	YSD 119	11.9	YSD 120	12.0	YSD 121	12.1	YSD 122	12.2	YSD 123	12.3	YSD 124	12.4	YSD 125	12.5	YSD 126	12.6	YSD 127	12.7	YSD 128	12.8	YSD 129	12.9	YSD 130	13.0	YSD 131	13.1	YSD 132	13.2	YSD 133	13.3	YSD 134	13.4	YSD 135	13.5	YSD 136	13.6	YSD 137	13.7	YSD 138	13.8	YSD 139	13.9	YSD 140	14.0	YSD 141	14.1	YSD 142	14.2	YSD 143	14.3	YSD 144	14.4	YSD 145	14.5	YSD 146	14.6	YSD 147	14.7	YSD 148	14.8	YSD 149	14.9	YSD 150	15.0	YSD 151	15.1	YSD 152	15.2	YSD 153	15.3	YSD 154	15.4	YSD 155	15.5	YSD 156	15.6	YSD 157	15.7	YSD 158	15.8	YSD 159	15.9	YSD 160	16.0	YSD 161	16.1	YSD 163	16.3	YSD 164	16.4	YSD 165	16.5	YSD 166	16.6	YSD 167	16.7	YSD 168	16.8	YSD 169	16.9	YSD 170	17.0	YSD 171	17.1	YSD 172	17.2	YSD 173	17.3	YSD 174	17.4	YSD 175	17.5	YSD 176	17.6	YSD 177	17.7	YSD 178	17.8	YSD 179	17.9	YSD 180	18.0	YSD 181	18.1	YSD 182	18.2	YSD 183	18.3	YSD 184	18.4	YSD 185	18.5	YSD 186	18.6	YSD 187	18.7	YSD 188	18.8	YSD 189	18.9	YSD 190	19.0	YSD 191	19.1	YSD 192	19.2	YSD 193	19.3	YSD 194	19.4	YSD 195	19.5	YSD 196	19.6	YSD 197	19.7	YSD 198	19.8	YSD 199	19.9	YSD 200	20.0																																																										
YSD 087	8.7	YSD 088	8.8	YSD 089	8.9	YSD 090	9.0	YSD 091	9.1	YSD 092	9.2	YSD 093	9.3	YSD 094	9.4	YSD 095	9.5	YSD 096	9.6	YSD 097	9.7	YSD 098	9.8	YSD 099	9.9	YSD 100	10.0	YSD 101	10.1	YSD 102	10.2	YSD 103	10.3	YSD 104	10.4	YSD 105	10.5	YSD 106	10.6	YSD 107	10.7	YSD 108	10.8	YSD 109	10.9	YSD 110	11.0	YSD 111	11.1	YSD 113	11.3	YSD 114	11.4	YSD 115	11.5	YSD 116	11.6	YSD 117	11.7	YSD 118	11.8	YSD 119	11.9	YSD 120	12.0	YSD 121	12.1	YSD 122	12.2	YSD 123	12.3	YSD 124	12.4	YSD 125	12.5	YSD 126	12.6	YSD 127	12.7	YSD 128	12.8	YSD 129	12.9	YSD 130	13.0	YSD 131	13.1	YSD 132	13.2	YSD 133	13.3	YSD 134	13.4	YSD 135	13.5	YSD 136	13.6	YSD 137	13.7	YSD 138	13.8	YSD 139	13.9	YSD 140	14.0	YSD 141	14.1	YSD 142	14.2	YSD 143	14.3	YSD 144	14.4	YSD 145	14.5	YSD 146	14.6	YSD 147	14.7	YSD 148	14.8	YSD 149	14.9	YSD 150	15.0	YSD 151	15.1	YSD 152	15.2	YSD 153	15.3	YSD 154	15.4	YSD 155	15.5	YSD 156	15.6	YSD 157	15.7	YSD 158	15.8	YSD 159	15.9	YSD 160	16.0	YSD 161	16.1	YSD 163	16.3	YSD 164	16.4	YSD 165	16.5	YSD 166	16.6	YSD 167	16.7	YSD 168	16.8	YSD 169	16.9	YSD 170	17.0	YSD 171	17.1	YSD 172	17.2	YSD 173	17.3	YSD 174	17.4	YSD 175	17.5	YSD 176	17.6	YSD 177	17.7	YSD 178	17.8	YSD 179	17.9	YSD 180	18.0	YSD 181	18.1	YSD 182	18.2	YSD 183	18.3	YSD 184	18.4	YSD 185	18.5	YSD 186	18.6	YSD 187	18.7	YSD 188	18.8	YSD 189	18.9	YSD 190	19.0	YSD 191	19.1	YSD 192	19.2	YSD 193	19.3	YSD 194	19.4	YSD 195	19.5	YSD 196	19.6	YSD 197	19.7	YSD 198	19.8	YSD 199	19.9	YSD 200	20.0																																																												
YSD 088	8.8	YSD 089	8.9	YSD 090	9.0	YSD 091	9.1	YSD 092	9.2	YSD 093	9.3	YSD 094	9.4	YSD 095	9.5	YSD 096	9.6	YSD 097	9.7	YSD 098	9.8	YSD 099	9.9	YSD 100	10.0	YSD 101	10.1	YSD 102	10.2	YSD 103	10.3	YSD 104	10.4	YSD 105	10.5	YSD 106	10.6	YSD 107	10.7	YSD 108	10.8	YSD 109	10.9	YSD 110	11.0	YSD 111	11.1	YSD 113	11.3	YSD 114	11.4	YSD 115	11.5	YSD 116	11.6	YSD 117	11.7	YSD 118	11.8	YSD 119	11.9	YSD 120	12.0	YSD 121	12.1	YSD 122	12.2	YSD 123	12.3	YSD 124	12.4	YSD 125	12.5	YSD 126	12.6	YSD 127	12.7	YSD 128	12.8	YSD 129	12.9	YSD 130	13.0	YSD 131	13.1	YSD 132	13.2	YSD 133	13.3	YSD 134	13.4	YSD 135	13.5	YSD 136	13.6	YSD 137	13.7	YSD 138	13.8	YSD 139	13.9	YSD 140	14.0	YSD 141	14.1	YSD 142	14.2	YSD 143	14.3	YSD 144	14.4	YSD 145	14.5	YSD 146	14.6	YSD 147	14.7	YSD 148	14.8	YSD 149	14.9	YSD 150	15.0	YSD 151	15.1	YSD 152	15.2	YSD 153	15.3	YSD 154	15.4	YSD 155	15.5	YSD 156	15.6	YSD 157	15.7	YSD 158	15.8	YSD 159	15.9	YSD 160	16.0	YSD 161	16.1	YSD 163	16.3	YSD 164	16.4	YSD 165	16.5	YSD 166	16.6	YSD 167	16.7	YSD 168	16.8	YSD 169	16.9	YSD 170	17.0	YSD 171	17.1	YSD 172	17.2	YSD 173	17.3	YSD 174	17.4	YSD 175	17.5	YSD 176	17.6	YSD 177	17.7	YSD 178	17.8	YSD 179	17.9	YSD 180	18.0	YSD 181	18.1	YSD 182	18.2	YSD 183	18.3	YSD 184	18.4	YSD 185	18.5	YSD 186	18.6	YSD 187	18.7	YSD 188	18.8	YSD 189	18.9	YSD 190	19.0	YSD 191	19.1	YSD 192	19.2	YSD 193	19.3	YSD 194	19.4	YSD 195	19.5	YSD 196	19.6	YSD 197	19.7	YSD 198	19.8	YSD 199	19.9	YSD 200	20.0																																																														
YSD 089	8.9	YSD 090	9.0	YSD 091	9.1	YSD 092	9.2	YSD 093	9.3	YSD 094	9.4	YSD 095	9.5	YSD 096	9.6	YSD 097	9.7	YSD 098	9.8	YSD 099	9.9	YSD 100	10.0	YSD 101	10.1	YSD 102	10.2	YSD 103	10.3	YSD 104	10.4	YSD 105	10.5	YSD 106	10.6	YSD 107	10.7	YSD 108	10.8	YSD 109	10.9	YSD 110	11.0	YSD 111	11.1	YSD 113	11.3	YSD 114	11.4	YSD 115	11.5	YSD 116	11.6	YSD 117	11.7	YSD 118	11.8	YSD 119	11.9	YSD 120	12.0	YSD 121	12.1	YSD 122	12.2	YSD 123	12.3	YSD 124	12.4	YSD 125	12.5	YSD 126	12.6	YSD 127	12.7	YSD 128	12.8	YSD 129	12.9	YSD 130	13.0	YSD 131	13.1	YSD 132	13.2	YSD 133	13.3	YSD 134	13.4	YSD 135	13.5	YSD 136	13.6	YSD 137	13.7	YSD 138	13.8	YSD 139	13.9	YSD 140	14.0	YSD 141	14.1	YSD 142	14.2	YSD 143	14.3	YSD 144	14.4	YSD 145	14.5	YSD 146	14.6	YSD 147	14.7	YSD 148	14.8	YSD 149	14.9	YSD 150	15.0	YSD 151	15.1	YSD 152	15.2	YSD 153	15.3	YSD 154	15.4	YSD 155	15.5	YSD 156	15.6	YSD 157	15.7	YSD 158	15.8	YSD 159	15.9	YSD 160	16.0	YSD 161	16.1	YSD 163	16.3	YSD 164	16.4	YSD 165	16.5	YSD 166	16.6	YSD 167	16.7	YSD 168	16.8	YSD 169	16.9	YSD 170	17.0	YSD 171	17.1	YSD 172	17.2	YSD 173	17.3	YSD 174	17.4	YSD 175	17.5	YSD 176	17.6	YSD 177	17.7	YSD 178	17.8	YSD 179	17.9	YSD 180	18.0	YSD 181	18.1	YSD 182	18.2	YSD 183	18.3	YSD 184	18.4	YSD 185	18.5	YSD 186	18.6	YSD 187	18.7	YSD 188	18.8	YSD 189	18.9	YSD 190	19.0	YSD 191	19.1	YSD 192	19.2	YSD 193	19.3	YSD 194	19.4	YSD 195	19.5	YSD 196	19.6	YSD 197	19.7	YSD 198	19.8	YSD 199	19.9	YSD 200	20.0																																																																
YSD 090	9.0	YSD 091	9.1	YSD 092	9.2	YSD 093	9.3	YSD 094	9.4	YSD 095	9.5	YSD 096	9.6	YSD 097	9.7	YSD 098	9.8	YSD 099	9.9	YSD 100	10.0	YSD 101	10.1	YSD 102	10.2	YSD 103	10.3	YSD 104	10.4	YSD 105	10.5	YSD 106	10.6	YSD 107	10.7	YSD 108	10.8	YSD 109	10.9	YSD 110	11.0	YSD 111	11.1	YSD 113	11.3	YSD 114	11.4	YSD 115	11.5	YSD 116	11.6	YSD 117	11.7	YSD 118	11.8	YSD 119	11.9	YSD 120	12.0	YSD 121	12.1	YSD 122	12.2	YSD 123	12.3	YSD 124	12.4	YSD 125	12.5	YSD 126	12.6	YSD 127	12.7	YSD 128	12.8	YSD 129	12.9	YSD 130	13.0	YSD 131	13.1	YSD 132	13.2	YSD 133	13.3	YSD 134	13.4	YSD 135	13.5	YSD 136	13.6	YSD 137	13.7	YSD 138	13.8	YSD 139	13.9	YSD 140	14.0	YSD 141	14.1	YSD 142	14.2	YSD 143	14.3	YSD 144	14.4	YSD 145	14.5	YSD 146	14.6	YSD 147	14.7	YSD 148	14.8	YSD 149	14.9	YSD 150	15.0	YSD 151	15.1	YSD 152	15.2	YSD 153	15.3	YSD 154	15.4	YSD 155	15.5	YSD 156	15.6	YSD 157	15.7	YSD 158	15.8	YSD 159	15.9	YSD 160	16.0	YSD 161	16.1	YSD 163	16.3	YSD 164	16.4	YSD 165	16.5	YSD 166	16.6	YSD 167	16.7	YSD 168	16.8	YSD 169	16.9	YSD 170	17.0	YSD 171	17.1	YSD 172	17.2	YSD 173	17.3	YSD 174	17.4	YSD 175	17.5	YSD 176	17.6	YSD 177	17.7	YSD 178	17.8	YSD 179	17.9	YSD 180	18.0	YSD 181	18.1	YSD 182	18.2	YSD 183	18.3	YSD 184	18.4	YSD 185	18.5	YSD 186	18.6	YSD 187	18.7	YSD 188	18.8	YSD 189	18.9	YSD 190	19.0	YSD 191	19.1	YSD 192	19.2	YSD 193	19.3	YSD 194	19.4	YSD 195	19.5	YSD 196	19.6	YSD 197	19.7	YSD 198	19.8	YSD 199	19.9	YSD 200	20.0																																																																		
YSD 091	9.1	YSD 092	9.2	YSD 093	9.3	YSD 094	9.4	YSD 095	9.5	YSD 096	9.6	YSD 097	9.7	YSD 098	9.8	YSD 099	9.9	YSD 100	10.0	YSD 101	10.1	YSD 102	10.2	YSD 103	10.3	YSD 104	10.4	YSD 105	10.5	YSD 106	10.6	YSD 107	10.7	YSD 108	10.8	YSD 109	10.9	YSD 110	11.0	YSD 111	11.1	YSD 113	11.3	YSD 114	11.4	YSD 115	11.5	YSD 116	11.6	YSD 117	11.7	YSD 118	11.8	YSD 119	11.9	YSD 120	12.0	YSD 121	12.1	YSD 122	12.2	YSD 123	12.3	YSD 124	12.4	YSD 125	12.5	YSD 126	12.6	YSD 127	12.7	YSD 128	12.8	YSD 129	12.9	YSD 130	13.0	YSD 131	13.1	YSD 132	13.2	YSD 133	13.3	YSD 134	13.4	YSD 135	13.5	YSD 136	13.6	YSD 137	13.7	YSD 138	13.8	YSD 139	13.9	YSD 140	14.0	YSD 141	14.1	YSD 142	14.2	YSD 143	14.3	YSD 144	14.4	YSD 145	14.5	YSD 146	14.6	YSD 147	14.7	YSD 148	14.8	YSD 149	14.9	YSD 150	15.0	YSD 151	15.1	YSD 152	15.2	YSD 153	15.3	YSD 154	15.4	YSD 155	15.5	YSD 156	15.6	YSD 157	15.7	YSD 158	15.8	YSD 159	15.9	YSD 160	16.0	YSD 161	16.1	YSD 163	16.3	YSD 164	16.4	YSD 165	16.5	YSD 166	16.6	YSD 167	16.7	YSD 168	16.8	YSD 169	16.9	YSD 170	17.0	YSD 171	17.1	YSD 172	17.2	YSD 173	17.3	YSD 174	17.4	YSD 175	17.5	YSD 176	17.6	YSD 177	17.7	YSD 178	17.8	YSD 179	17.9	YSD 180	18.0	YSD 181	18.1	YSD 182	18.2	YSD 183	18.3	YSD 184	18.4	YSD 185	18.5	YSD 186	18.6	YSD 187	18.7	YSD 188	18.8	YSD 189	18.9	YSD 190	19.0	YSD 191	19.1	YSD 192	19.2	YSD 193	19.3	YSD 194	19.4	YSD 195	19.5	YSD 196	19.6	YSD 197	19.7	YSD 198	19.8	YSD 199	19.9	YSD 200	20.0																																																																				
YSD 092	9.2	YSD 093	9.3	YSD 094	9.4	YSD 095	9.5	YSD 096	9.6	YSD 097	9.7	YSD 098	9.8	YSD 099	9.9	YSD 100	10.0	YSD 101	10.1	YSD 102	10.2	YSD 103	10.3	YSD 104	10.4	YSD 105	10.5	YSD 106	10.6	YSD 107	10.7	YSD 108	10.8	YSD 109	10.9	YSD 110	11.0	YSD 111	11.1	YSD 113	11.3	YSD 114	11.4	YSD 115	11.5	YSD 116	11.6	YSD 117	11.7	YSD 118	11.8	YSD 119	11.9	YSD 120	12.0	YSD 121	12.1	YSD 122	12.2	YSD 123	12.3	YSD 124	12.4	YSD 125	12.5	YSD 126	12.6	YSD 127	12.7	YSD 128	12.8	YSD 129	12.9	YSD 130	13.0	YSD 131	13.1	YSD 132	13.2	YSD 133	13.3	YSD 134	13.4	YSD 135	13.5	YSD 136	13.6	YSD 137	13.7	YSD 138	13.8	YSD 139	13.9	YSD 140	14.0	YSD 141	14.1	YSD 142	14.2	YSD 143	14.3	YSD 144	14.4	YSD 145	14.5	YSD 146	14.6	YSD 147	14.7	YSD 148	14.8	YSD 149	14.9	YSD 150	15.0	YSD 151	15.1	YSD 152	15.2	YSD 153	15.3	YSD 154	15.4	YSD 155	15.5	YSD 156	15.6	YSD 157	15.7	YSD 158	15.8	YSD 159	15.9	YSD 160	16.0	YSD 161	16.1	YSD 163	16.3	YSD 164	16.4	YSD 165	16.5	YSD 166	16.6	YSD 167	16.7	YSD 168	16.8	YSD 169	16.9	YSD 170	17.0	YSD 171	17.1	YSD 172	17.2	YSD 173	17.3	YSD 174	17.4	YSD 175	17.5	YSD 176	17.6	YSD 177	17.7	YSD 178	17.8	YSD 179	17.9	YSD 180	18.0	YSD 181	18.1	YSD 182	18.2	YSD 183	18.3	YSD 184	18.4	YSD 185	18.5	YSD 186	18.6	YSD 187	18.7	YSD 188	18.8	YSD 189	18.9	YSD 190	19.0	YSD 191	19.1	YSD 192	19.2	YSD 193	19.3	YSD 194	19.4	YSD 195	19.5	YSD 196	19.6	YSD 197	19.7	YSD 198	19.8	YSD 199	19.9	YSD 200	20.0																																																																						
YSD 093	9.3	YSD 094	9.4	YSD 095	9.5	YSD 096	9.6	YSD 097	9.7	YSD 098	9.8	YSD 099	9.9	YSD 100	10.0	YSD 101	10.1	YSD 102	10.2	YSD 103	10.3	YSD 104	10.4	YSD 105	10.5	YSD 106	10.6	YSD 107	10.7	YSD 108	10.8	YSD 109	10.9	YSD 110	11.0	YSD 111	11.1	YSD 113	11.3	YSD 114	11.4	YSD 115	11.5	YSD 116	11.6	YSD 117	11.7	YSD 118	11.8	YSD 119	11.9	YSD 120	12.0	YSD 121	12.1	YSD 122	12.2	YSD 123	12.3	YSD 124	12.4	YSD 125	12.5	YSD 126	12.6	YSD 127	12.7	YSD 128	12.8	YSD 129	12.9	YSD 130	13.0	YSD 131	13.1	YSD 132	13.2	YSD 133	13.3	YSD 134	13.4	YSD 135	13.5	YSD 136	13.6	YSD 137	13.7	YSD 138	13.8	YSD 139	13.9	YSD 140	14.0	YSD 141	14.1	YSD 142	14.2	YSD 143	14.3	YSD 144	14.4	YSD 145	14.5	YSD 146	14.6	YSD 147	14.7	YSD 148	14.8	YSD 149	14.9	YSD 150	15.0	YSD 151	15.1	YSD 152	15.2	YSD 153	15.3	YSD 154	15.4	YSD 155	15.5	YSD 156	15.6	YSD 157	15.7	YSD 158	15.8	YSD 159	15.9	YSD 160	16.0	YSD 161	16.1	YSD 163	16.3	YSD 164	16.4	YSD 165	16.5	YSD 166	16.6	YSD 167	16.7	YSD 168	16.8	YSD 169	16.9	YSD 170	17.0	YSD 171	17.1	YSD 172	17.2	YSD 173	17.3	YSD 174	17.4	YSD 175	17.5	YSD 176	17.6	YSD 177	17.7	YSD 178	17.8	YSD 179	17.9	YSD 180	18.0	YSD 181	18.1	YSD 182	18.2	YSD 183	18.3	YSD 184	18.4	YSD 185	18.5	YSD 186	18.6	YSD 187	18.7	YSD 188	18.8	YSD 189	18.9	YSD 190	19.0	YSD 191	19.1	YSD 192	19.2	YSD 193	19.3	YSD 194	19.4	YSD 195	19.5	YSD 196	19.6	YSD 197	19.7	YSD 198	19.8	YSD 199	19.9	YSD 200	20.0																																																																								
YSD 094	9.4	YSD 095	9.5	YSD 096	9.6	YSD 097	9.7	YSD 098	9.8	YSD 099	9.9	YSD 100	10.0	YSD 101	10.1	YSD 102	10.2	YSD 103	10.3	YSD 104	10.4	YSD 105	10.5	YSD 106	10.6	YSD 107	10.7	YSD 108	10.8	YSD 109	10.9	YSD 110	11.0	YSD 111	11.1	YSD 113	11.3	YSD 114	11.4	YSD 115	11.5	YSD 116	11.6	YSD 117	11.7	YSD 118	11.8	YSD 119	11.9	YSD 120	12.0	YSD 121	12.1	YSD 122	12.2	YSD 123	12.3	YSD 124	12.4	YSD 125	12.5	YSD 126	12.6	YSD 127	12.7	YSD 128	12.8	YSD 129	12.9	YSD 130	13.0	YSD 131	13.1	YSD 132	13.2	YSD 133	13.3	YSD 134	13.4	YSD 135	13.5	YSD 136	13.6	YSD 137	13.7	YSD 138	13.8	YSD 139	13.9	YSD 140	14.0	YSD 141	14.1	YSD 142	14.2	YSD 143	14.3	YSD 144	14.4	YSD 145	14.5	YSD 146	14.6	YSD 147	14.7	YSD 148	14.8	YSD 149	14.9	YSD 150	15.0	YSD 151	15.1	YSD 152	15.2	YSD 153	15.3	YSD 154	15.4	YSD 155	15.5	YSD 156	15.6	YSD 157	15.7	YSD 158	15.8	YSD 159	15.9	YSD 160	16.0	YSD 161	16.1	YSD 163	16.3	YSD 164	16.4	YSD 165	16.5	YSD 166	16.6	YSD 167	16.7	YSD 168	16.8	YSD 169	16.9	YSD 170	17.0	YSD 171	17.1	YSD 172	17.2	YSD 173	17.3	YSD 174	17.4	YSD 175	17.5	YSD 176	17.6	YSD 177	17.7	YSD 178	17.8	YSD 179	17.9	YSD 180	18.0	YSD 181	18.1	YSD 182	18.2	YSD 183	18.3	YSD 184	18.4	YSD 185	18.5	YSD 186	18.6	YSD 187	18.7	YSD 188	18.8	YSD 189	18.9	YSD 190	19.0	YSD 191	19.1	YSD 192	19.2	YSD 193	19.3	YSD 194	19.4	YSD 195	19.5	YSD 196	19.6	YSD 197	19.7	YSD 198	19.8	YSD 199	19.9	YSD 200	20.0																																																																										
YSD 095	9.5	YSD 096	9.6	YSD 097	9.7	YSD 098	9.8	YSD 099	9.9	YSD 100	10.0	YSD 101	10.1	YSD 102	10.2	YSD 103	10.3	YSD 104	10.4	YSD 105	10.5	YSD 106	10.6	YSD 107	10.7	YSD 108	10.8	YSD 109	10.9	YSD 110	11.0	YSD 111	11.1	YSD 113	11.3	YSD 114	11.4	YSD 115	11.5	YSD 116	11.6	YSD 117	11.7	YSD 118	11.8	YSD 119	11.9	YSD 120	12.0	YSD 121	12.1	YSD 122	12.2	YSD 123	12.3	YSD 124	12.4	YSD 125	12.5	YSD 126	12.6	YSD 127	12.7	YSD 128	12.8	YSD 129	12.9	YSD 130	13.0	YSD 131	13.1	YSD 132	13.2	YSD 133	13.3	YSD 134	13.4	YSD 135	13.5	YSD 136	13.6	YSD 137	13.7	YSD 138	13.8	YSD 139	13.9	YSD 140	14.0	YSD 141	14.1	YSD 142	14.2	YSD 143	14.3	YSD 144	14.4	YSD 145	14.5	YSD 146	14.6	YSD 147	14.7	YSD 148	14.8	YSD 149	14.9	YSD 150	15.0	YSD 151	15.1	YSD 152	15.2	YSD 153	15.3	YSD 154	15.4	YSD 155	15.5	YSD 156	15.6	YSD 157	15.7	YSD 158	15.8	YSD 159	15.9	YSD 160	16.0	YSD 161	16.1	YSD 163	16.3	YSD 164	16.4	YSD 165	16.5	YSD 166	16.6	YSD 167	16.7	YSD 168	16.8	YSD 169	16.9	YSD 170	17.0	YSD 171	17.1	YSD 172	17.2	YSD 173	17.3	YSD 174	17.4	YSD 175	17.5	YSD 176	17.6	YSD 177	17.7	YSD 178	17.8	YSD 179	17.9	YSD 180	18.0	YSD 181	18.1	YSD 182	18.2	YSD 183	18.3	YSD 184	18.4	YSD 185	18.5	YSD 186	18.6	YSD 187	18.7	YSD 188	18.8	YSD 189	18.9	YSD 190	19.0	YSD 191	19.1	YSD 192	19.2	YSD 193	19.3	YSD 194	19.4	YSD 195	19.5	YSD 196	19.6	YSD 197	19.7	YSD 198	19.8	YSD 199	19.9	YSD 200	20.0																																																																												
YSD 096	9.6	YSD 097	9.7	YSD 098	9.8	YSD 099	9.9	YSD 100	10.0	YSD 101	10.1	YSD 102	10.2	YSD 103	10.3	YSD 104	10.4	YSD 105	10.5	YSD 106	10.6	YSD 107	10.7	YSD 108	10.8	YSD 109	10.9	YSD 110	11.0	YSD 111	11.1	YSD 113	11.3	YSD 114	11.4	YSD 115	11.5	YSD 116	11.6	YSD 117	11.7	YSD 118	11.8	YSD 119	11.9	YSD 120	12.0	YSD 121	12.1	YSD 122	12.2	YSD 123	12.3	YSD 124	12.4	YSD 125	12.5	YSD 126	12.6	YSD 127	12.7	YSD 128	12.8	YSD 129	12.9	YSD 130	13.0	YSD 131	13.1	YSD 132	13.2	YSD 133	13.3	YSD 134	13.4	YSD 135	13.5	YSD 136	13.6	YSD 137	13.7	YSD 138	13.8	YSD 139	13.9	YSD 140	14.0	YSD 141	14.1	YSD 142	14.2	YSD 143	14.3	YSD 144	14.4	YSD 145	14.5	YSD 146	14.6	YSD 147	14.7	YSD 148	14.8	YSD 149	14.9	YSD 150	15.0	YSD 151	15.1	YSD 152	15.2	YSD 153	15.3	YSD 154	15.4	YSD 155	15.5	YSD 156	15.6	YSD 157	15.7	YSD 158	15.8	YSD 159	15.9	YSD 160	16.0	YSD 161	16.1	YSD 163	16.3	YSD 164	16.4	YSD 165	16.5	YSD 166	16.6	YSD 167	16.7	YSD 168	16.8	YSD 169	16.9	YSD 170	17.0	YSD 171	17.1	YSD 172	17.2	YSD 173	17.3	YSD 174	17.4	YSD 175	17.5	YSD 176	17.6	YSD 177	17.7	YSD 178	17.8	YSD 179	17.9	YSD 180	18.0	YSD 181	18.1	YSD 182	18.2	YSD 183	18.3	YSD 184	18.4	YSD 185	18.5	YSD 186	18.6	YSD 187	18.7	YSD 188	18.8	YSD 189	18.9	YSD 190	19.0	YSD 191	19.1	YSD 192	19.2	YSD 193	19.3	YSD 194	19.4	YSD 195	19.5	YSD 196	19.6	YSD 197	19.7	YSD 198	19.8	YSD 199	19.9	YSD 200	20.0																																																																														
YSD 097	9.7	YSD 098	9.8	YSD 099	9.9	YSD 100	10.0	YSD 101	10.1	YSD 102	10.2	YSD 103	10.3	YSD 104	10.4	YSD 105	10.5	YSD 106	10.6	YSD 107	10.7	YSD 108	10.8	YSD 109	10.9	YSD 110	11.0	YSD 111	11.1	YSD 113	11.3	YSD 114	11.4	YSD 115	11.5	YSD 116	11.6	YSD 117	11.7	YSD 118	11.8	YSD 119	11.9	YSD 120	12.0	YSD 121	12.1	YSD 122	12.2	YSD 123	12.3	YSD 124	12.4	YSD 125	12.5	YSD 126	12.6	YSD 127	12.7	YSD 128	12.8	YSD 129	12.9	YSD 130	13.0	YSD 131	13.1	YSD 132	13.2	YSD 133	13.3	YSD 134	13.4	YSD 135	13.5	YSD 136	13.6	YSD 137	13.7	YSD 138	13.8	YSD 139	13.9	YSD 140	14.0	YSD 141	14.1	YSD 142	14.2	YSD 143	14.3	YSD 144	14.4	YSD 145	14.5	YSD 146	14.6	YSD 147	14.7	YSD 148	14.8	YSD 149	14.9	YSD 150	15.0	YSD 151	15.1	YSD 152	15.2	YSD 153	15.3	YSD 154	15.4	YSD 155	15.5	YSD 156	15.6	YSD 157	15.7	YSD 158	15.8	YSD 159	15.9	YSD 160	16.0	YSD 161	16.1	YSD 163	16.3	YSD 164	16.4	YSD 165	16.5	YSD 166	16.6	YSD 167	16.7	YSD 168	16.8	YSD 169	16.9	YSD 170	17.0	YSD 171	17.1	YSD 172	17.2	YSD 173	17.3	YSD 174	17.4	YSD 175	17.5	YSD 176	17.6	YSD 177	17.7	YSD 178	17.8	YSD 179	17.9	YSD 180	18.0	YSD 181	18.1	YSD 182	18.2	YSD 183	18.3	YSD 184	18.4	YSD 185	18.5	YSD 186	18.6	YSD 187	18.7	YSD 188	18.8	YSD 189	18.9	YSD 190	19.0	YSD 191	19.1	YSD 192	19.2	YSD 193	19.3	YSD 194	19.4	YSD 195	19.5	YSD 196	19.6	YSD 197	19.7	YSD 198	19.8	YSD 199	19.9	YSD 200	20.0																																																																																
YSD 098	9.8	YSD 099	9.9	YSD 100	10.0	YSD 101	10.1	YSD 102	10.2	YSD 103	10.3	YSD 104	10.4	YSD 105	10.5	YSD 106	10.6	YSD 107	10.7	YSD 108	10.8	YSD 109	10.9	YSD 110	11.0	YSD 111	11.1	YSD 113	11.3	YSD 114	11.4	YSD 115	11.5	YSD 116	11.6	YSD 117	11.7	YSD 118	11.8	YSD 119	11.9	YSD 120	12.0	YSD 121	12.1	YSD 122	12.2	YSD 123	12.3	YSD 124	12.4	YSD 125	12.5	YSD 126	12.6	YSD 127	12.7	YSD 128	12.8	YSD 129	12.9	YSD 130	13.0	YSD 131	13.1	YSD 132	13.2	YSD 133	13.3	YSD 134	13.4	YSD 135	13.5	YSD 136	13.6	YSD 137	13.7	YSD 138	13.8	YSD 139	13.9	YSD 140	14.0	YSD 141	14.1	YSD 142	14.2	YSD 143	14.3	YSD 144	14.4	YSD 145	14.5	YSD 146	14.6	YSD 147	14.7	YSD 148	14.8	YSD 149	14.9	YSD 150	15.0	YSD 151	15.1	YSD 152	15.2	YSD 153	15.3	YSD 154	15.4	YSD 155	15.5	YSD 156	15.6	YSD 157	15.7	YSD 158	15.8	YSD 159	15.9	YSD 160	16.0	YSD 161	16.1	YSD 163	16.3	YSD 164	16.4	YSD 165	16.5	YSD 166	16.6	YSD 167	16.7	YSD 168	16.8	YSD 169	16.9	YSD 170	17.0	YSD 171	17.1	YSD 172	17.2	YSD 173	17.3	YSD 174	17.4	YSD 175	17.5	YSD 176	17.6	YSD 177	17.7	YSD 178	17.8	YSD 179	17.9	YSD 180	18.0	YSD 181	18.1	YSD 182	18.2	YSD 183	18.3	YSD 184	18.4	YSD 185	18.5	YSD 186	18.6	YSD 187	18.7	YSD 188	18.8	YSD 189	18.9	YSD 190	19.0	YSD 191	19.1	YSD 192	19.2	YSD 193	19.3	YSD 194	19.4	YSD 195	19.5	YSD 196	19.6	YSD 197	19.7	YSD 198	19.8	YSD 199	19.9	YSD 200	20.0																																																																																		
YSD 099	9.9	YSD 100	10.0	YSD 101	10.1	YSD 102	10.2	YSD 103	10.3	YSD 104	10.4	YSD 105	10.5	YSD 106	10.6	YSD 107	10.7	YSD 108	10.8	YSD 109	10.9	YSD 110	11.0	YSD 111	11.1	YSD 113	11.3	YSD 114	11.4	YSD 115	11.5	YSD 116	11.6	YSD 117	11.7	YSD 118	11.8	YSD 119	11.9	YSD 120	12.0	YSD 121	12.1	YSD 122	12.2	YSD 123	12.3	YSD 124	12.4	YSD 125	12.5	YSD 126	12.6	YSD 127	12.7	YSD 128	12.8	YSD 129	12.9	YSD 130	13.0	YSD 131	13.1	YSD 132	13.2	YSD 133	13.3	YSD 134	13.4	YSD 135	13.5	YSD 136	13.6	YSD 137	13.7	YSD 138	13.8	YSD 139	13.9	YSD 140	14.0	YSD 141	14.1	YSD 142	14.2	YSD 143	14.3	YSD 144	14.4	YSD 145	14.5	YSD 146	14.6	YSD 147	14.7	YSD 148	14.8	YSD 149	14.9	YSD 150	15.0	YSD 151	15.1	YSD 152	15.2	YSD 153	15.3	YSD 154	15.4	YSD 155	15.5	YSD 156	15.6	YSD 157	15.7	YSD 158	15.8	YSD 159	15.9	YSD 160	16.0	YSD 161	16.1	YSD 163	16.3	YSD 164	16.4	YSD 165	16.5	YSD 166	16.6	YSD 167	16.7	YSD 168	16.8	YSD 169	16.9	YSD 170	17.0	YSD 171	17.1	YSD 172	17.2	YSD 173	17.3	YSD 174	17.4	YSD 175	17.5	YSD 176	17.6	YSD 177	17.7	YSD 178	17.8	YSD 179	17.9	YSD 180	18.0	YSD 181	18.1	YSD 182	18.2	YSD 183	18.3	YSD 184	18.4	YSD 185	18.5	YSD 186	18.6	YSD 187	18.7	YSD 188	18.8	YSD 189	18.9	YSD 190	19.0	YSD 191	19.1	YSD 192	19.2	YSD 193	19.3	YSD 194	19.4	YSD 195	19.5	YSD 196	19.6	YSD 197	19.7	YSD 198	19.8	YSD 199	19.9	YSD 200	20.0																																																																																				
YSD 100	10.0	YSD 101	10.1	YSD 102	10.2	YSD 103	10.3	YSD 104	10.4	YSD 105	10.5	YSD 106	10.6	YSD 107	10.7	YSD 108	10.8	YSD 109	10.9	YSD 110	11.0	YSD 111	11.1	YSD 113	11.3	YSD 114	11.4	YSD 115	11.5	YSD 116	11.6	YSD 117	11.7	YSD 118	11.8	YSD 119	11.9	YSD 120	12.0	YSD 121	12.1	YSD 122	12.2	YSD 123	12.3	YSD 124	12.4	YSD 125	12.5	YSD 126	12.6	YSD 127	12.7	YSD 128	12.8	YSD 129	12.9	YSD 130	13.0	YSD 131	13.1	YSD 132	13.2	YSD 133	13.3	YSD 134	13.4	YSD 135	13.5	YSD 136	13.6	YSD 137	13.7	YSD 138	13.8	YSD 139	13.9	YSD 140	14.0	YSD 141	14.1	YSD 142	14.2	YSD 143	14.3	YSD 144	14.4	YSD 145	14.5	YSD 146	14.6	YSD 147	14.7	YSD 148	14.8	YSD 149	14.9	YSD 150	15.0	YSD 151	15.1	YSD 152	15.2	YSD 153	15.3	YSD 154	15.4	YSD 155	15.5	YSD 156	15.6	YSD 157	15.7	YSD 158	15.8	YSD 159	15.9	YSD 160	16.0	YSD 161	16.1	YSD 163	16.3	YSD 164	16.4	YSD 165	16.5	YSD 166	16.6	YSD 167	16.7	YSD 168	16.8	YSD 169	16.9	YSD 170	17.0	YSD 171	17.1	YSD 172	17.2	YSD 173	17.3	YSD 174	17.4	YSD 175	17.5	YSD 176	17.6	YSD 177	17.7	YSD 178	17.8	YSD 179	17.9	YSD 180	18.0	YSD 181	18.1	YSD 182	18.2	YSD 183	18.3	YSD 184	18.4	YSD 185	18.5	YSD 186	18.6	YSD 187	18.7	YSD 188	18.8	YSD 189	18.9	YSD 190	19.0	YSD 191	19.1	YSD 192	19.2	YSD 193	19.3	YSD 194	19.4	YSD 195	19.5	YSD 196	19.6	YSD 197	19.7	YSD 198	19.8	YSD 199	19.9	YSD 200	20.0																																																																																						
YSD 101	10.1	YSD 102	10.2	YSD 103	10.3	YSD 104	10.4	YSD 105	10.5	YSD 106	10.6	YSD 107	10.7	YSD 108	10.8	YSD 109	10.9	YSD 110	11.0	YSD 111	11.1	YSD 113	11.3	YSD 114	11.4	YSD 115	11.5	YSD 116	11.6	YSD 117	11.7	YSD 118	11.8	YSD 119	11.9	YSD 120	12.0	YSD 121	12.1	YSD 122	12.2	YSD 123	12.3	YSD 124	12.4	YSD 125	12.5	YSD 126	12.6	YSD 127	12.7	YSD 128	12.8	YSD 129	12.9	YSD 130	13.0	YSD 131	13.1	YSD 132	13.2	YSD 133	13.3	YSD 134	13.4	YSD 135	13.5	YSD 136	13.6	YSD 137	13.7	YSD 138	13.8	YSD 139	13.9	YSD 140	14.0	YSD 141	14.1	YSD 142	14.2	YSD 143	14.3	YSD 144	14.4	YSD 145	14.5	YSD 146	14.6	YSD 147	14.7	YSD 148	14.8	YSD 149	14.9	YSD 150	15.0	YSD 151	15.1	YSD 152	15.2	YSD 153	15.3	YSD 154	15.4	YSD 155	15.5	YSD 156	15.6	YSD 157	15.7	YSD 158	15.8	YSD 159	15.9	YSD 160	16.0	YSD 161	16.1	YSD 163	16.3	YSD 164	16.4	YSD 165	16.5	YSD 166	16.6	YSD 167	16.7	YSD 168	16.8	YSD 169	16.9	YSD 170	17.0	YSD 171	17.1	YSD 172	17.2	YSD 173	17.3	YSD 174	17.4	YSD 175	17.5	YSD 176	17.6	YSD 177	17.7	YSD 178	17.8	YSD 179	17.9	YSD 180	18.0	YSD 181	18.1	YSD 182	18.2	YSD 183	18.3	YSD 184	18.4	YSD 185	18.5	YSD 186	18.6	YSD 187	18.7	YSD 188	18.8	YSD 189	18.9	YSD 190	19.0	YSD 191	19.1	YSD 192	19.2	YSD 193	19.3	YSD 194	19.4	YSD 195	19.5	YSD 196	19.6	YSD 197	19.7	YSD 198	19.8	YSD 199	19.9	YSD 200	20.0																																																																																								
YSD 102	10.2	YSD 103	10.3	YSD 104	10.4	YSD 105	10.5	YSD 106	10.6	YSD 107	10.7	YSD 108	10.8	YSD 109	10.9	YSD 110	11.0	YSD 111	11.1	YSD 113	11.3	YSD 114	11.4	YSD 115	11.5	YSD 116	11.6	YSD 117	11.7	YSD 118	11.8	YSD 119	11.9	YSD 120	12.0	YSD 121	12.1	YSD 122	12.2	YSD 123	12.3	YSD 124	12.4	YSD 125	12.5	YSD 126	12.6	YSD 127	12.7	YSD 128	12.8	YSD 129	12.9	YSD 130	13.0	YSD 131	13.1	YSD 132	13.2	YSD 133	13.3	YSD 134	13.4	YSD 135	13.5	YSD 136	13.6	YSD 137	13.7	YSD 138	13.8	YSD 139	13.9	YSD 140	14.0	YSD 141	14.1	YSD 142	14.2	YSD 143	14.3	YSD 144	14.4	YSD 145	14.5	YSD 146	14.6	YSD 147	14.7	YSD 148	14.8	YSD 149	14.9	YSD 150	15.0	YSD 151	15.1	YSD 152	15.2	YSD 153	15.3	YSD 154	15.4	YSD 155	15.5	YSD 156	15.6	YSD 157	15.7	YSD 158	15.8	YSD 159	15.9	YSD 160	16.0	YSD 161	16.1	YSD 163	16.3	YSD 164	16.4	YSD 165	16.5	YSD 166	16.6	YSD 167	16.7	YSD 168	16.8	YSD 169	16.9	YSD 170	17.0	YSD 171	17.1	YSD 172	17.2	YSD 173	17.3	YSD 174	17.4	YSD 175	17.5	YSD 176	17.6	YSD 177	17.7	YSD 178	17.8	YSD 179	17.9	YSD 180	18.0	YSD 181	18.1	YSD 182	18.2	YSD 183	18.3	YSD 184	18.4	YSD 185	18.5	YSD 186	18.6	YSD 187	18.7	YSD 188	18.8	YSD 189	18.9	YSD 190	19.0	YSD 191	19.1	YSD 192	19.2	YSD 193	19.3	YSD 194	19.4	YSD 195	19.5	YSD 196	19.6	YSD 197	19.7	YSD 198	19.8	YSD 199	19.9	YSD 200	20.0																																																																																										
YSD 103	10.3	YSD 104	10.4	YSD 105	10.5	YSD 106	10.6	YSD 107	10.7	YSD 108	10.8	YSD 109	10.9	YSD 110	11.0	YSD 111	11.1	YSD 113	11.3	YSD 114	11.4	YSD 115	11.5	YSD 116	11.6	YSD 117	11.7	YSD 118	11.8	YSD 119	11.9	YSD 120	12.0	YSD 121	12.1	YSD 122	12.2	YSD 123	12.3	YSD 124	12.4	YSD 125	12.5	YSD 126	12.6	YSD 127	12.7	YSD 128	12.8	YSD 129	12.9	YSD 130	13.0	YSD 131	13.1	YSD 132	13.2	YSD 133	13.3	YSD 134	13.4	YSD 135	13.5	YSD 136	13.6	YSD 137	13.7	YSD 138	13.8	YSD 139	13.9	YSD 140	14.0	YSD 141	14.1	YSD 142	14.2	YSD 143	14.3	YSD 144	14.4	YSD 145	14.5	YSD 146	14.6	YSD 147	14.7	YSD 148	14.8	YSD 149	14.9	YSD 150	15.0	YSD 151	15.1	YSD 152	15.2	YSD 153	15.3	YSD 154	15.4	YSD 155	15.5	YSD 156	15.6	YSD 157	15.7	YSD 158	15.8	YSD 159	15.9	YSD 160	16.0	YSD 161	16.1	YSD 163	16.3	YSD 164	16.4	YSD 165	16.5	YSD 166	16.6	YSD 167	16.7	YSD 168	16.8	YSD 169	16.9	YSD 170	17.0	YSD 171	17.1	YSD 172	17.2	YSD 173	17.3	YSD 174	17.4	YSD 175	17.5	YSD 176	17.6	YSD 177	17.7	YSD 178	17.8	YSD 179	17.9	YSD 180	18.0	YSD 181	18.1	YSD 182	18.2	YSD 183	18.3	YSD 184	18.4	YSD 185	18.5	YSD 186	18.6	YSD 187	18.7	YSD 188	18.8	YSD 189	18.9	YSD 190	19.0	YSD 191	19.1	YSD 192	19.2	YSD 193	19.3	YSD 194	19.4	YSD 195	19.5	YSD 196	19.6	YSD 197	19.7	YSD 198	19.8	YSD 199	19.9	YSD 200	20.0																																																																																												
YSD 104	10.4	YSD 105	10.5	YSD 106	10.6	YSD 107	10.7	YSD 108	10.8	YSD 109	10.9	YSD 110	11.0	YSD 111	11.1	YSD 113	11.3	YSD 114	11.4	YSD 115	11.5	YSD 116	11.6	YSD 117	11.7	YSD 118	11.8	YSD 119	11.9	YSD 120	12.0	YSD 121	12.1	YSD 122	12.2	YSD 123	12.3	YSD 124	12.4	YSD 125	12.5	YSD 126	12.6	YSD 127	12.7	YSD 128	12.8	YSD 129	12.9	YSD 130	13.0	YSD 131	13.1	YSD 132	13.2	YSD 133	13.3	YSD 134	13.4	YSD 135	13.5	YSD 136	13.6	YSD 137	13.7	YSD 138	13.8	YSD 139	13.9	YSD 140	14.0	YSD 141	14.1	YSD 142	14.2	YSD 143	14.3	YSD 144	14.4	YSD 145	14.5	YSD 146	14.6	YSD 147	14.7	YSD 148	14.8	YSD 149	14.9	YSD 150	15.0	YSD 151	15.1	YSD 152	15.2	YSD 153	15.3	YSD 154	15.4	YSD 155	15.5	YSD 156	15.6	YSD 157	15.7	YSD 158	15.8	YSD 159	15.9	YSD 160	16.0	YSD 161	16.1	YSD 163	16.3	YSD 164	16.4	YSD 165	16.5	YSD 166	16.6	YSD 167	16.7	YSD 168	16.8	YSD 169	16.9	YSD 170	17.0	YSD 171	17.1	YSD 172	17.2	YSD 173	17.3	YSD 174	17.4	YSD 175	17.5	YSD 176	17.6	YSD 177	17.7	YSD 178	17.8	YSD 179	17.9	YSD 180	18.0	YSD 181	18.1	YSD 182	18.2	YSD 183	18.3	YSD 184	18.4	YSD 185	18.5	YSD 186	18.6	YSD 187	18.7	YSD 188	18.8	YSD 189	18.9	YSD 190	19.0	YSD 191	19.1	YSD 192	19.2	YSD 193	19.3	YSD 194	19.4	YSD 195	19.5	YSD 196	19.6	YSD 197	19.7	YSD 198	19.8	YSD 199	19.9	YSD 200	20.0																																																																																														
YSD 105	10.5	YSD 106	10.6	YSD 107	10.7	YSD 108	10.8	YSD 109	10.9	YSD 110	11.0	YSD 111	11.1	YSD 113	11.3	YSD 114	11.4	YSD 115	11.5	YSD 116	11.6	YSD 117	11.7	YSD 118	11.8	YSD 119	11.9	YSD 120	12.0	YSD 121	12.1	YSD 122	12.2	YSD 123	12.3	YSD 124	12.4	YSD 125	12.5	YSD 126	12.6	YSD 127	12.7	YSD 128	12.8	YSD 129	12.9	YSD 130	13.0	YSD 131	13.1	YSD 132	13.2	YSD 133	13.3	YSD 134	13.4	YSD 135	13.5	YSD 136	13.6	YSD 137	13.7	YSD 138	13.8	YSD 139	13.9	YSD 140	14.0	YSD 141	14.1	YSD 142	14.2	YSD 143	14.3	YSD 144	14.4	YSD 145	14.5	YSD 146	14.6	YSD 147	14.7	YSD 148	14.8	YSD 149	14.9	YSD 150	15.0	YSD 151	15.1	YSD 152	15.2	YSD 153	15.3	YSD 154	15.4	YSD 155	15.5	YSD 156	15.6	YSD 157	15.7	YSD 158	15.8	YSD 159	15.9	YSD 160	16.0	YSD 161	16.1	YSD 163	16.3	YSD 164	16.4	YSD 165	16.5	YSD 166	16.6	YSD 167	16.7	YSD 168	16.8	YSD 169	16.9	YSD 170	17.0	YSD 171	17.1	YSD 172	17.2	YSD 173	17.3	YSD 174	17.4	YSD 175	17.5	YSD 176	17.6	YSD 177	17.7	YSD 178	17.8	YSD 179	17.9	YSD 180	18.0	YSD 181	18.1	YSD 182	18.2	YSD 183	18.3	YSD 184	18.4	YSD 185	18.5	YSD 186	18.6	YSD 187	18.7	YSD 188	18.8	YSD 189	18.9	YSD 190	19.0	YSD 191	19.1	YSD 192	19.2	YSD 193	19.3	YSD 194	19.4	YSD 195	19.5	YSD 196	19.6	YSD 197	19.7	YSD 198	19.8	YSD 199	19.9	YSD 200	20.0																																																																																																
YSD 106	10.6	YSD 107	10.7	YSD 108	10.8	YSD 109	10.9	YSD 110	11.0	YSD 111	11.1	YSD 113	11.3	YSD 114	11.4	YSD 115	11.5	YSD 116	11.6	YSD 117	11.7	YSD 118	11.8	YSD 119	11.9	YSD 120	12.0	YSD 121	12.1	YSD 122	12.2	YSD 123	12.3	YSD 124	12.4	YSD 125	12.5	YSD 126	12.6	YSD 127	12.7	YSD 128	12.8	YSD 129	12.9	YSD 130	13.0	YSD 131	13.1	YSD 132	13.2	YSD 133	13.3	YSD 134	13.4	YSD 135	13.5	YSD 136	13.6	YSD 137	13.7	YSD 138	13.8	YSD 139	13.9	YSD 140	14.0	YSD 141	14.1	YSD 142	14.2	YSD 143	14.3	YSD 144	14.4	YSD 145	14.5	YSD 146	14.6	YSD 147	14.7	YSD 148	14.8	YSD 149	14.9	YSD 150	15.0	YSD 151	15.1	YSD 152	15.2	YSD 153	15.3	YSD 154	15.4	YSD 155	15.5	YSD 156	15.6	YSD 157	15.7	YSD 158	15.8	YSD 159	15.9	YSD 160	16.0	YSD 161	16.1	YSD 163	16.3	YSD 164	16.4	YSD 165	16.5	YSD 166	16.6	YSD 167	16.7	YSD 168	16.8	YSD 169	16.9	YSD 170	17.0	YSD 171	17.1	YSD 172	17.2	YSD 173	17.3	YSD 174	17.4	YSD 175	17.5	YSD 176	17.6	YSD 177	17.7	YSD 178	17.8	YSD 179	17.9	YSD 180	18.0	YSD 181	18.1	YSD 182	18.2	YSD 183	18.3	YSD 184	18.4	YSD 185	18.5	YSD 186	18.6	YSD 187	18.7	YSD 188	18.8	YSD 189	18.9	YSD 190	19.0	YSD 191	19.1	YSD 192	19.2	YSD 193	19.3	YSD 194	19.4	YSD 195	19.5	YSD 196	19.6	YSD 197	19.7	YSD 198	19.8	YSD 199	19.9	YSD 200	20.0																																																																																																		
YSD 107	10.7	YSD 108	10.8	YSD 109	10.9	YSD 110	11.0	YSD 111	11.1	YSD 113	11.3	YSD 114	11.4	YSD 115	11.5	YSD 116	11.6	YSD 117	11.7	YSD 118	11.8	YSD 119	11.9	YSD 120	12.0	YSD 121	12.1	YSD 122	12.2	YSD 123	12.3	YSD 124	12.4	YSD 125	12.5	YSD 126	12.6	YSD 127	12.7	YSD 128	12.8	YSD 129	12.9	YSD 130	13.0	YSD 131	13.1	YSD 132	13.2	YSD 133	13.3	YSD 134	13.4	YSD 135	13.5	YSD 136	13.6	YSD 137	13.7	YSD 138	13.8	YSD 139	13.9	YSD 140	14.0	YSD 141	14.1	YSD 142	14.2	YSD 143	14.3	YSD 144	14.4	YSD 145	14.5	YSD 146	14.6	YSD 147	14.7	YSD 148	14.8	YSD 149	14.9	YSD 150	15.0	YSD 151	15.1	YSD 152	15.2	YSD 153	15.3	YSD 154	15.4	YSD 155	15.5	YSD 156	15.6	YSD 157	15.7	YSD 158	15.8	YSD 159	15.9	YSD 160	16.0	YSD 161	16.1	YSD 163	16.3	YSD 164	16.4	YSD 165	16.5	YSD 166	16.6	YSD 167	16.7	YSD 168	16.8	YSD 169	16.9	YSD 170	17.0	YSD 171	17.1	YSD 172	17.2	YSD 173	17.3	YSD 174	17.4	YSD 175	17.5	YSD 176	17.6	YSD 177	17.7	YSD 178	17.8	YSD 179	17.9	YSD 180	18.0	YSD 181	18.1	YSD 182	18.2	YSD 183	18.3	YSD 184	18.4	YSD 185	18.5	YSD 186	18.6	YSD 187	18.7	YSD 188	18.8	YSD 189	18.9	YSD 190	19.0	YSD 191	19.1	YSD 192	19.2	YSD 193	19.3	YSD 194	19.4	YSD 195	19.5	YSD 196	19.6	YSD 197	19.7	YSD 198	19.8	YSD 199	19.9	YSD 200	20.0																																																																																																				
YSD 108	10.8	YSD 109	10.9	YSD 110	11.0	YSD 111	11.1	YSD 113	11.3	YSD 114	11.4	YSD 115	11.5	YSD 116	11.6	YSD 117	11.7	YSD 118	11.8	YSD 119	11.9	YSD 120	12.0	YSD 121	12.1	YSD 122	12.2	YSD 123	12.3	YSD 124	12.4	YSD 125	12.5	YSD 126	12.6	YSD 127	12.7	YSD 128	12.8	YSD 129	12.9	YSD 130	13.0	YSD 131	13.1	YSD 132	13.2	YSD 133	13.3	YSD 134	13.4	YSD 135	13.5	YSD 136	13.6	YSD 137	13.7	YSD 138	13.8	YSD 139	13.9	YSD 140	14.0	YSD 141	14.1	YSD 142	14.2	YSD 143	14.3	YSD 144	14.4	YSD 145	14.5	YSD 146	14.6	YSD 147	14.7	YSD 148	14.8	YSD 149	14.9	YSD 150	15.0	YSD 151	15.1	YSD 152	15.2	YSD 153	15.3	YSD 154	15.4	YSD 155	15.5	YSD 156	15.6	YSD 157	15.7	YSD 158	15.8	YSD 159	15.9	YSD 160	16.0	YSD 161	16.1	YSD 163	16.3	YSD 164	16.4	YSD 165	16.5	YSD 166	16.6	YSD 167	16.7	YSD 168	16.8	YSD 169	16.9	YSD 170	17.0	YSD 171	17.1	YSD 172	17.2	YSD 173	17.3	YSD 174	17.4	YSD 175	17.5	YSD 176	17.6	YSD 177	17.7	YSD 178	17.8	YSD 179	17.9	YSD 180	18.0	YSD 181	18.1	YSD 182	18.2	YSD 183	18.3	YSD 184	18.4	YSD 185	18.5	YSD 186	18.6	YSD 187	18.7	YSD 188	18.8	YSD 189	18.9	YSD 190	19.0	YSD 191	19.1	YSD 192	19.2	YSD 193	19.3	YSD 194	19.4	YSD 195	19.5	YSD 196	19.6	YSD 197	19.7	YSD 198	19.8	YSD 199	19.9	YSD 200	20.0																																																																																																						
YSD 109	10.9	YSD 110	11.0	YSD 111	11.1	YSD 113	11.3	YSD 114	11.4	YSD 115	11.5	YSD 116	11.6	YSD 117	11.7	YSD 118	11.8	YSD 119	11.9	YSD 120	12.0	YSD 121	12.1	YSD 122	12.2	YSD 123	12.3	YSD 124	12.4	YSD 125	12.5	YSD 126	12.6	YSD 127	12.7	YSD 128	12.8	YSD 129	12.9	YSD 130	13.0	YSD 131	13.1	YSD 132	13.2	YSD 133	13.3	YSD 134	13.4	YSD 135	13.5	YSD 136	13.6	YSD 137	13.7	YSD 138	13.8	YSD 139	13.9	YSD 140	14.0	YSD 141	14.1	YSD 142	14.2	YSD 143	14.3	YSD 144	14.4	YSD 145	14.5	YSD 146	14.6	YSD 147	14.7	YSD 148	14.8	YSD 149	14.9	YSD 150	15.0	YSD 151	15.1	YSD 152	15.2	YSD 153	15.3	YSD 154	15.4	YSD 155	15.5	YSD 156	15.6	YSD 157	15.7	YSD 158	15.8	YSD 159	15.9	YSD 160	16.0	YSD 161	16.1	YSD 163	16.3	YSD 164	16.4	YSD 165	16.5	YSD 166	16.6	YSD 167	16.7	YSD 168	16.8	YSD 169	16.9	YSD 170	17.0	YSD 171	17.1	YSD 172	17.2	YSD 173	17.3	YSD 174	17.4	YSD 175	17.5	YSD 176	17.6	YSD 177	17.7	YSD 178	17.8	YSD 179	17.9	YSD 180	18.0	YSD 181	18.1	YSD 182	18.2	YSD 183	18.3	YSD 184	18.4	YSD 185	18.5	YSD 186	18.6	YSD 187	18.7	YSD 188	18.8	YSD 189	18.9	YSD 190	19.0	YSD 191	19.1	YSD 192	19.2	YSD 193	19.3	YSD 194	19.4	YSD 195	19.5	YSD 196	19.6	YSD 197	19.7	YSD 198	19.8	YSD 199	19.9	YSD 200	20.0																																																																																																								
YSD 110	11.0	YSD 111	11.1	YSD 113	11.3	YSD 114	11.4	YSD 115	11.5	YSD 116	11.6	YSD 117	11.7	YSD 118	11.8	YSD 119	11.9	YSD 120	12.0	YSD 121	12.1	YSD 122	12.2	YSD 123	12.3	YSD 124	12.4	YSD 125	12.5	YSD 126	12.6	YSD 127	12.7	YSD 128	12.8	YSD 129	12.9	YSD 130	13.0	YSD 131	13.1	YSD 132	13.2	YSD 133	13.3	YSD 134	13.4	YSD 135	13.5	YSD 136	13.6	YSD 137	13.7	YSD 138	13.8	YSD 139	13.9	YSD 140	14.0	YSD 141	14.1	YSD 142	14.2	YSD 143	14.3	YSD 144	14.4	YSD 145	14.5	YSD 146	14.6	YSD 147	14.7	YSD 148	14.8	YSD 149	14.9	YSD 150	15.0	YSD 151	15.1	YSD 152	15.2	YSD 153	15.3	YSD 154	15.4	YSD 155	15.5	YSD 156	15.6	YSD 157	15.7	YSD 158	15.8	YSD 159	15.9	YSD 160	16.0	YSD 161	16.1	YSD 163	16.3	YSD 164	16.4	YSD 165	16.5	YSD 166	16.6	YSD 167	16.7	YSD 168	16.8	YSD 169	16.9	YSD 170	17.0	YSD 171	17.1	YSD 172	17.2	YSD 173	17.3	YSD 174	17.4	YSD 175	17.5	YSD 176	17.6	YSD 177	17.7	YSD 178	17.8	YSD 179	17.9	YSD 180	18.0	YSD 181	18.1	YSD 182	18.2	YSD 183	18.3	YSD 184	18.4	YSD 185	18.5	YSD 186	18.6	YSD 187	18.7	YSD 188	18.8	YSD 189	18.9	YSD 190	19.0	YSD 191	19.1	YSD 192	19.2	YSD 193	19.3	YSD 194	19.4	YSD 195	19.5	YSD 196	19.6	YSD 197	19.7	YSD 198	19.8	YSD 199	19.9	YSD 200	20.0																																																																																																										
YSD 111	11.1	YSD 113	11.3	YSD 114	11.4	YSD 115	11.5	YSD 116	11.6	YSD 117	11.7	YSD 118	11.8	YSD 119	11.9	YSD 120	12.0	YSD 121	12.1	YSD 122	12.2	YSD 123	12.3	YSD 124	12.4	YSD 125	12.5	YSD 126	12.6	YSD 127	12.7	YSD 128	12.8	YSD 129	12.9	YSD 130	13.0	YSD 131	13.1	YSD 132	13.2	YSD 133	13.3	YSD 134	13.4	YSD 135	13.5	YSD 136	13.6	YSD 137	13.7	YSD 138	13.8	YSD 139	13.9	YSD 140	14.0	YSD 141	14.1	YSD 142	14.2	YSD 143	14.3	YSD 144	14.4	YSD 145	14.5	YSD 146	14.6	YSD 147	14.7	YSD 148	14.8	YSD 149	14.9	YSD 150	15.0	YSD 151	15.1	YSD 152	15.2	YSD 153	15.3	YSD 154	15.4	YSD 155	15.5	YSD 156	15.6	YSD 157	15.7	YSD 158	15.8	YSD 159	15.9	YSD 160	16.0	YSD 161	16.1	YSD 163	16.3	YSD 164	16.4	YSD 165	16.5	YSD 166	16.6	YSD 167	16.7	YSD 168	16.8	YSD 169	16.9	YSD 170	17.0	YSD 171	17.1	YSD 172	17.2	YSD 173	17.3	YSD 174	17.4	YSD 175	17.5	YSD 176	17.6	YSD 177	17.7	YSD 178	17.8	YSD 179	17.9	YSD 180	18.0	YSD 181	18.1	YSD 182	18.2	YSD 183	18.3	YSD 184	18.4	YSD 185	18.5	YSD 186	18.6	YSD 187	18.7	YSD 188	18.8	YSD 189	18.9	YSD 190	19.0	YSD 191	19.1	YSD 192	19.2	YSD 193	19.3	YSD 194	19.4	YSD 195	19.5	YSD 196	19.6	YSD 197	19.7	YSD 198	19.8	YSD 199	19.9	YSD 200	20.0																																																																																																												
YSD 113	11.3	YSD 114	11.4	YSD 115	11.5	YSD 116	11.6	YSD 117	11.7	YSD 118	11.8	YSD 119	11.9	YSD 120	12.0	YSD 121	12.1	YSD 122	12.2	YSD 123	12.3	YSD 124	12.4	YSD 125	12.5	YSD 126	12.6	YSD 127	12.7	YSD 128	12.8	YSD 129	12.9	YSD 130	13.0	YSD 131	13.1	YSD 132	13.2	YSD 133	13.3	YSD 134	13.4	YSD 135	13.5	YSD 136	13.6	YSD 137	13.7	YSD 138	13.8	YSD 139	13.9	YSD 140	14.0	YSD 141	14.1	YSD 142	14.2	YSD 143	14.3	YSD 144	14.4	YSD 145	14.5	YSD 146	14.6	YSD 147	14.7	YSD 148	14.8	YSD 149	14.9	YSD 150	15.0	YSD 151	15.1	YSD 152	15.2	YSD 153	15.3	YSD 154	15.4	YSD 155	15.5	YSD 156	15.6	YSD 157	15.7	YSD 158	15.8	YSD 159	15.9	YSD 160	16.0	YSD 161	16.1	YSD 163	16.3	YSD 164	16.4	YSD 165	16.5	YSD 166	16.6	YSD 167	16.7	YSD 168	16.8	YSD 169	16.9	YSD 170	17.0	YSD 171	17.1	YSD 172	17.2	YSD 173	17.3	YSD 174	17.4	YSD 175	17.5	YSD 176	17.6	YSD 177	17.7	YSD 178	17.8	YSD 179	17.9	YSD 180	18.0	YSD 181	18.1	YSD 182	18.2	YSD 183	18.3	YSD 184	18.4	YSD 185	18.5	YSD 186	18.6	YSD 187	18.7	YSD 188	18.8	YSD 189	18.9	YSD 190	19.0	YSD 191	19.1	YSD 192	19.2	YSD 193	19.3	YSD 194	19.4	YSD 195	19.5	YSD 196	19.6	YSD 197	19.7	YSD 198	19.8	YSD 199	19.9	YSD 200	20.0																																																																																																														
YSD 114	11.4	YSD 115	11.5	YSD 116	11.6	YSD 117	11.7	YSD 118	11.8	YSD 119	11.9	YSD 120	12.0	YSD 121	12.1	YSD 122	12.2	YSD 123	12.3	YSD 124	12.4	YSD 125	12.5	YSD 126	12.6	YSD 127	12.7	YSD 128	12.8	YSD 129	12.9	YSD 130	13.0	YSD 131	13.1	YSD 132	13.2	YSD 133	13.3	YSD 134	13.4	YSD 135	13.5	YSD 136	13.6	YSD 137	13.7	YSD 138	13.8	YSD 139	13.9	YSD 140	14.0	YSD 141	14.1	YSD 142	14.2	YSD 143	14.3	YSD 144	14.4	YSD 145	14.5	YSD 146	14.6	YSD 147	14.7	YSD 148	14.8	YSD 149	14.9	YSD 150	15.0	YSD 151	15.1	YSD 152	15.2	YSD 153	15.3	YSD 154	15.4	YSD 155	15.5	YSD 156	15.6	YSD 157	15.7	YSD 158	15.8	YSD 159	15.9	YSD 160	16.0	YSD 161	16.1	YSD 163	16.3	YSD 164	16.4	YSD 165	16.5	YSD 166	16.6	YSD 167	16.7	YSD 168	16.8	YSD 169	16.9	YSD 170	17.0	YSD 171	17.1	YSD 172	17.2	YSD 173	17.3	YSD 174	17.4	YSD 175	17.5	YSD 176	17.6	YSD 177	17.7	YSD 178	17.8	YSD 179	17.9	YSD 180	18.0	YSD 181	18.1	YSD 182	18.2	YSD 183	18.3	YSD 184	18.4	YSD 185	18.5	YSD 186	18.6	YSD 187	18.7	YSD 188	18.8	YSD 189	18.9	YSD 190	19.0	YSD 191	19.1	YSD 192	19.2	YSD 193	19.3	YSD 194	19.4	YSD 195	19.5	YSD 196	19.6	YSD 197	19.7	YSD 198	19.8	YSD 199	19.9	YSD 200	20.0																																																																																																																
YSD 115	11.5	YSD 116	11.6	YSD 117	11.7	YSD 118	11.8	YSD 119	11.9	YSD 120	12.0	YSD 121	12.1	YSD 122	12.2	YSD 123	12.3	YSD 124	12.4	YSD 125	12.5	YSD 126	12.6	YSD 127	12.7	YSD 128	12.8	YSD 129	12.9	YSD 130	13.0	YSD 131	13.1	YSD 132	13.2	YSD 133	13.3	YSD 134	13.4	YSD 135	13.5	YSD 136	13.6	YSD 137	13.7	YSD 138	13.8	YSD 139	13.9	YSD 140	14.0	YSD 141	14.1	YSD 142	14.2	YSD 143	14.3	YSD 144	14.4	YSD 145	14.5	YSD 146	14.6	YSD 147	14.7	YSD 148	14.8	YSD 149	14.9	YSD 150	15.0	YSD 151	15.1	YSD 152	15.2	YSD 153	15.3	YSD 154	15.4	YSD 155	15.5	YSD 156	15.6	YSD 157	15.7	YSD 158	15.8	YSD 159	15.9	YSD 160	16.0	YSD 161	16.1	YSD 163	16.3	YSD 164	16.4	YSD 165	16.5	YSD 166	16.6	YSD 167	16.7	YSD 168	16.8	YSD 169	16.9	YSD 170	17.0	YSD 171	17.1	YSD 172	17.2	YSD 173	17.3	YSD 174	17.4	YSD 175	17.5	YSD 176	17.6	YSD 177	17.7	YSD 178	17.8	YSD 179	17.9	YSD 180	18.0	YSD 181	18.1	YSD 182	18.2	YSD 183	18.3	YSD 184	18.4	YSD 185	18.5	YSD 186	18.6	YSD 187	18.7	YSD 188	18.8	YSD 189	18.9	YSD 190	19.0	YSD 191	19.1	YSD 192	19.2	YSD 193	19.3	YSD 194	19.4	YSD 195	19.5	YSD 196	19.6	YSD 197	19.7	YSD 198	19.8	YSD 199	19.9	YSD 200	20.0																																																																																																																		
YSD 116	11.6	YSD 117	11.7	YSD 118	11.8	YSD 119	11.9	YSD 120	12.0	YSD 121	12.1	YSD 122	12.2	YSD 123	12.3	YSD 124	12.4	YSD 125	12.5	YSD 126	12.6	YSD 127	12.7	YSD 128	12.8	YSD 129	12.9	YSD 130	13.0	YSD 131	13.1	YSD 132	13.2	YSD 133	13.3	YSD 134	13.4	YSD 135	13.5	YSD 136	13.6	YSD 137	13.7	YSD 138	13.8	YSD 139	13.9	YSD 140	14.0	YSD 141	14.1	YSD 142	14.2	YSD 143	14.3	YSD 144	14.4	YSD 145	14.5	YSD 146	14.6	YSD 147	14.7	YSD 148	14.8	YSD 149	14.9	YSD 150	15.0	YSD 151	15.1	YSD 152	15.2	YSD 153	15.3	YSD 154	15.4	YSD 155	15.5	YSD 156	15.6	YSD 157	15.7	YSD 158	15.8	YSD 159	15.9	YSD 160	16.0	YSD 161	16.1	YSD 163	16.3	YSD 164	16.4	YSD 165	16.5	YSD 166	16.6	YSD 167	16.7	YSD 168	16.8	YSD 169	16.9	YSD 170	17.0	YSD 171	17.1	YSD 172	17.2	YSD 173	17.3	YSD 174	17.4	YSD 175	17.5	YSD 176	17.6	YSD 177	17.7	YSD 178	17.8	YSD 179	17.9	YSD 180	18.0	YSD 181	18.1	YSD 182	18.2	YSD 183	18.3	YSD 184	18.4	YSD 185	18.5	YSD 186	18.6	YSD 187	18.7	YSD 188	18.8	YSD 189	18.9	YSD 190	19.0	YSD 191	19.1	YSD 192	19.2	YSD 193	19.3	YSD 194	19.4	YSD 195	19.5	YSD 196	19.6	YSD 197	19.7	YSD 198	19.8	YSD 199	19.9	YSD 200	20.0																																																																																																																				
YSD 117	11.7	YSD 118	11.8	YSD 119	11.9	YSD 120	12.0	YSD 121	12.1	YSD 122	12.2	YSD 123	12.3	YSD 124	12.4	YSD 125	12.5	YSD 126	12.6	YSD 127	12.7	YSD 128	12.8	YSD 129	12.9	YSD 130	13.0	YSD 131	13.1	YSD 132	13.2	YSD 133	13.3	YSD 134	13.4	YSD 135	13.5	YSD 136	13.6	YSD 137	13.7	YSD 138	13.8	YSD 139	13.9	YSD 140	14.0	YSD 141	14.1	YSD 142	14.2	YSD 143	14.3	YSD 144	14.4	YSD 145	14.5	YSD 146	14.6	YSD 147	14.7	YSD 148	14.8	YSD 149	14.9	YSD 150	15.0	YSD 151	15.1	YSD 152	15.2	YSD 153	15.3	YSD 154	15.4	YSD 155	15.5	YSD 156	15.6	YSD 157	15.7	YSD 158	15.8	YSD 159	15.9	YSD 160	16.0	YSD 161	16.1	YSD 163	16.3	YSD 164	16.4	YSD 165	16.5	YSD 166	16.6	YSD 167	16.7	YSD 168	16.8	YSD 169	16.9	YSD 170	17.0	YSD 171	17.1	YSD 172	17.2	YSD 173	17.3	YSD 174	17.4	YSD 175	17.5	YSD 176	17.6	YSD 177	17.7	YSD 178	17.8	YSD 179	17.9	YSD 180	18.0	YSD 181	18.1	YSD 182	18.2	YSD 183	18.3	YSD 184	18.4	YSD 185	18.5	YSD 186	18.6	YSD 187	18.7	YSD 188	18.8	YSD 189	18.9	YSD 190	19.0	YSD 191	19.1	YSD 192	19.2	YSD 193	19.3	YSD 194	19.4	YSD 195	19.5	YSD 196	19.6	YSD 197	19.7	YSD 198	19.8	YSD 199	19.9	YSD 200	20.0																																																																																																																						
YSD 118	11.8	YSD 119	11.9	YSD 120	12.0	YSD 121	12.1	YSD 122	12.2	YSD 123	12.3	YSD 124	12.4	YSD 125	12.5	YSD 126	12.6	YSD 127	12.7	YSD 128	12.8	YSD 129	12.9	YSD 130	13.0	YSD 131	13.1	YSD 132	13.2	YSD 133	13.3	YSD 134	13.4	YSD 135	13.5	YSD 136	13.6	YSD 137	13.7	YSD 138	13.8	YSD 139	13.9	YSD 140	14.0	YSD 141	14.1	YSD 142	14.2	YSD 143	14.3	YSD 144	14.4	YSD 145	14.5	YSD 146	14.6	YSD 147	14.7	YSD 148	14.8	YSD 149	14.9	YSD 150	15.0	YSD 151	15.1	YSD 152	15.2	YSD 153	15.3	YSD 154	15.4	YSD 155	15.5	YSD 156	15.6	YSD 157	15.7	YSD 158	15.8	YSD 159	15.9	YSD 160	16.0	YSD 161	16.1	YSD 163	16.3	YSD 164	16.4	YSD 165	16.5	YSD 166	16.6	YSD 167	16.7	YSD 168	16.8	YSD 169	16.9	YSD 170	17.0	YSD 171	17.1	YSD 172	17.2	YSD 173	17.3	YSD 174	17.4	YSD 175	17.5	YSD 176	17.6	YSD 177	17.7	YSD 178	17.8	YSD 179	17.9	YSD 180	18.0	YSD 181	18.1	YSD 182	18.2	YSD 183	18.3	YSD 184	18.4	YSD 185	18.5	YSD 186	18.6	YSD 187	18.7	YSD 188	18.8	YSD 189	18.9	YSD 190	19.0	YSD 191	19.1	YSD 192	19.2	YSD 193	19.3	YSD 194	19.4	YSD 195	19.5	YSD 196	19.6	YSD 197	19.7	YSD 198	19.8	YSD 199	19.9	YSD 200	20.0																																																																																																																								
YSD 119	11.9	YSD 120	12.0	YSD 121	12.1	YSD 122	12.2	YSD 123	12.3	YSD 124	12.4	YSD 125	12.5	YSD 126	12.6	YSD 127	12.7	YSD 128	12.8	YSD 129	12.9	YSD 130	13.0	YSD 131	13.1	YSD 132	13.2	YSD 133	13.3	YSD 134	13.4	YSD 135	13.5	YSD 136	13.6	YSD 137	13.7	YSD 138	13.8	YSD 139	13.9	YSD 140	14.0	YSD 141	14.1	YSD 142	14.2	YSD 143	14.3	YSD 144	14.4	YSD 145	14.5	YSD 146	14.6	YSD 147	14.7	YSD 148	14.8	YSD 149	14.9	YSD 150	15.0	YSD 151	15.1	YSD 152	15.2	YSD 153	15.3	YSD 154	15.4	YSD 155	15.5	YSD 156	15.6	YSD 157	15.7	YSD 158	15.8	YSD 159	15.9	YSD 160	16.0	YSD 161	16.1	YSD 163	16.3	YSD 164	16.4	YSD 165	16.5	YSD 166	16.6	YSD 167	16.7	YSD 168	16.8	YSD 169	16.9	YSD 170	17.0	YSD 171	17.1	YSD 172	17.2	YSD 173	17.3	YSD 174	17.4	YSD 175	17.5	YSD 176	17.6	YSD 177	17.7	YSD 178	17.8	YSD 179	17.9	YSD 180	18.0	YSD 181	18.1	YSD 182	18.2	YSD 183	18.3	YSD 184	18.4	YSD 185	18.5	YSD 186	18.6	YSD 187	18.7	YSD 188	18.8	YSD 189	18.9	YSD 190	19.0	YSD 191	19.1	YSD 192	19.2	YSD 193	19.3	YSD 194	19.4	YSD 195	19.5	YSD 196	19.6	YSD 197	19.7	YSD 198	19.8	YSD 199	19.9	YSD 200	20.0																																																																																																																										
YSD 120	12.0	YSD 121	12.1	YSD 122	12.2	YSD 123	12.3	YSD 124	12.4	YSD 125	12.5	YSD 126	12.6	YSD 127	12.7	YSD 128	12.8	YSD 129	12.9	YSD 130	13.0	YSD 131	13.1	YSD 132	13.2	YSD 133	13.3	YSD 134	13.4	YSD 135	13.5	YSD 136	13.6	YSD 137	13.7	YSD 138	13.8	YSD 139	13.9	YSD 140	14.0	YSD 141	14.1	YSD 142	14.2	YSD 143	14.3	YSD 144	14.4	YSD 145	14.5	YSD 146	14.6	YSD 147	14.7	YSD 148	14.8	YSD 149	14.9	YSD 150	15.0	YSD 151	15.1	YSD 152	15.2	YSD 153	15.3	YSD 154	15.4	YSD 155	15.5	YSD 156	15.6	YSD 157	15.7	YSD 158	15.8	YSD 159	15.9	YSD 160	16.0	YSD 161	16.1	YSD 163	16.3	YSD 164	16.4	YSD 165	16.5	YSD 166	16.6	YSD 167	16.7	YSD 168	16.8	YSD 169	16.9	YSD 170	17.0	YSD 171	17.1	YSD 172	17.2	YSD 173	17.3	YSD 174	17.4	YSD 175	17.5	YSD 176	17.6	YSD 177	17.7	YSD 178	17.8	YSD 179	17.9	YSD 180	18.0	YSD 181	18.1	YSD 182	18.2	YSD 183	18.3	YSD 184	18.4	YSD 185	18.5	YSD 186	18.6	YSD 187	18.7	YSD 188	18.8	YSD 189	18.9	YSD 190	19.0	YSD 191	19.1	YSD 192	19.2	YSD 193	19.3	YSD 194	19.4	YSD 195	19.5	YSD 196	19.6	YSD 197	19.7	YSD 198	19.8	YSD 199	19.9	YSD 200	20.0																																																																																																																												
YSD 121	12.1	YSD 122	12.2	YSD 123	12.3	YSD 124	12.4	YSD 125	12.5	YSD 126	12.6	YSD 127	12.7	YSD 128	12.8	YSD 129	12.9	YSD 130	13.0	YSD 131	13.1	YSD 132	13.2	YSD 133	13.3	YSD 134	13.4	YSD 135	13.5	YSD 136	13.6	YSD 137	13.7	YSD 138	13.8	YSD 139	13.9	YSD 140	14.0	YSD 141	14.1	YSD 142	14.2	YSD 143	14.3	YSD 144	14.4	YSD 145	14.5	YSD 146	14.6	YSD 147	14.7	YSD 148	14.8	YSD 149	14.9	YSD 150	15.0	YSD 151	15.1	YSD 152	15.2	YSD 153	15.3	YSD 154	15.4	YSD 155	15.5	YSD 156	15.6	YSD 157	15.7	YSD 158	15.8	YSD 159	15.9	YSD 160	16.0	YSD 161	16.1	YSD 163	16.3	YSD 164	16.4	YSD 165	16.5	YSD 166	16.6	YSD 167	16.7	YSD 168	16.8	YSD 169	16.9	YSD 170	17.0	YSD 171	17.1	YSD 172	17.2	YSD 173	17.3	YSD 174	17.4	YSD 175	17.5	YSD 176	17.6	YSD 177	17.7	YSD 178	17.8	YSD 179	17.9	YSD 180	18.0	YSD 181	18.1	YSD 182	18.2	YSD 183	18.3	YSD 184	18.4	YSD 185	18.5	YSD 186	18.6	YSD 187	18.7	YSD 188	18.8	YSD 189	18.9	YSD 190	19.0	YSD 191	19.1	YSD 192	19.2	YSD 193	19.3	YSD 194	19.4	YSD 195	19.5	YSD 196	19.6	YSD 197	19.7	YSD 198	19.8	YSD 199	19.9	YSD 200	20.0																																																																																																																														
YSD 122	12.2	YSD 123	12.3	YSD 124	12.4	YSD 125	12.5	YSD 126	12.6	YSD 127	12.7	YSD 128	12.8	YSD 129	12.9	YSD 130	13.0	YSD 131	13.1	YSD 132	13.2	YSD 133	13.3	YSD 134	13.4	YSD 135	13.5	YSD 136	13.6	YSD 137	13.7	YSD 138	13.8	YSD 139	13.9	YSD 140	14.0	YSD 141	14.1	YSD 142	14.2	YSD 143	14.3	YSD 144	14.4	YSD 145	14.5	YSD 146	14.6	YSD 147	14.7	YSD 148	14.8	YSD 149	14.9	YSD 150	15.0	YSD 151	15.1	YSD 152	15.2	YSD 153	15.3	YSD 154	15.4	YSD 155	15.5	YSD 156	15.6	YSD 157	15.7	YSD 158	15.8	YSD 159	15.9	YSD 160	16.0	YSD 161	16.1	YSD 163	16.3	YSD 164	16.4	YSD 165	16.5	YSD 166	16.6	YSD 167	16.7	YSD 168	16.8	YSD 169	16.9	YSD 170	17.0	YSD 171	17.1	YSD 172	17.2	YSD 173	17.3	YSD 174	17.4	YSD 175	17.5	YSD 176	17.6	YSD 177	17.7	YSD 178	17.8	YSD 179	17.9	YSD 180	18.0	YSD 181	18.1	YSD 182	18.2	YSD 183	18.3	YSD 184	18.4	YSD 185	18.5	YSD 186	18.6	YSD 187	18.7	YSD 188	18.8	YSD 189	18.9	YSD 190	19.0	YSD 191	19.1	YSD 192	19.2	YSD 193	19.3	YSD 194	19.4	YSD 195	19.5	YSD 196	19.6	YSD 197	19.7	YSD 198	19.8	YSD 199	19.9	YSD 200	20.0																																																																																																																																
YSD 123	12.3	YSD 124	12.4	YSD 125	12.5	YSD 126	12.6	YSD 127	12.7	YSD 128	12.8	YSD 129	12.9	YSD 130	13.0	YSD 131	13.1	YSD 132	13.2	YSD 133	13.3	YSD 134	13.4	YSD 135	13.5	YSD 136	13.6	YSD 137	13.7	YSD 138	13.8	YSD 139	13.9	YSD 140	14.0	YSD 141	14.1	YSD 142	14.2	YSD 143	14.3	YSD 144	14.4	YSD 145	14.5	YSD 146	14.6	YSD 147	14.7	YSD 148	14.8	YSD 149	14.9	YSD 150	15.0	YSD 151	15.1	YSD 152	15.2	YSD 153	15.3	YSD 154	15.4	YSD 155	15.5	YSD 156	15.6	YSD 157	15.7	YSD 158	15.8	YSD 159	15.9	YSD 160	16.0	YSD 161	16.1	YSD 163	16.3	YSD 164	16.4	YSD 165	16.5	YSD 166	16.6	YSD 167	16.7	YSD 168	16.8	YSD 169	16.9	YSD 170	17.0	YSD 171	17.1	YSD 172	17.2	YSD 173	17.3	YSD 174	17.4	YSD 175	17.5	YSD 176	17.6	YSD 177	17.7	YSD 178	17.8	YSD 179	17.9	YSD 180	18.0	YSD 181	18.1	YSD 182	18.2	YSD 183	18.3	YSD 184	18.4	YSD 185	18.5	YSD 186	18.6	YSD 187	18.7	YSD 188	18.8	YSD 189	18.9	YSD 190	19.0	YSD 191	19.1	YSD 192	19.2	YSD 193	19.3	YSD 194	19.4	YSD 195	19.5	YSD 196	19.6	YSD 197	19.7	YSD 198	19.8	YSD 199	19.9	YSD 200	20.0																																																																																																																																		
YSD 124	12.4	YSD 125	12.5	YSD 126	12.6	YSD 127	12.7	YSD 128	12.8	YSD 129	12.9	YSD 130	13.0	YSD 131	13.1	YSD 132	13.2	YSD 133	13.3	YSD 134	13.4	YSD 135	13.5	YSD 136	13.6	YSD 137	13.7	YSD 138	13.8	YSD 139	13.9	YSD 140	14.0	YSD 141	14.1	YSD 142	14.2	YSD 143	14.3	YSD 144	14.4	YSD 145	14.5	YSD 146	14.6	YSD 147	14.7	YSD 148	14.8	YSD 149	14.9	YSD 150	15.0	YSD 151	15.1	YSD 152	15.2	YSD 153	15.3	YSD 154	15.4	YSD 155	15.5	YSD 156	15.6	YSD 157	15.7	YSD 158	15.8	YSD 159	15.9	YSD 160	16.0	YSD 161	16.1	YSD 163	16.3	YSD 164	16.4	YSD 165	16.5	YSD 166	16.6	YSD 167	16.7	YSD 168	16.8	YSD 169	16.9	YSD 170	17.0	YSD 171	17.1	YSD 172	17.2	YSD 173	17.3	YSD 174	17.4	YSD 175	17.5	YSD 176	17.6	YSD 177	17.7	YSD 178	17.8	YSD 179	17.9	YSD 180	18.0	YSD 181	18.1	YSD 182	18.2	YSD 183	18.3	YSD 184	18.4	YSD 185	18.5	YSD 186	18.6	YSD 187	18.7	YSD 188	18.8	YSD 189	18.9	YSD 190	19.0	YSD 191	19.1	YSD 192	19.2	YSD 193	19.3	YSD 194	19.4	YSD 195	19.5	YSD 196	19.6	YSD 197	19.7	YSD 198	19.8	YSD 199	19.9	YSD 200	20.0																																																																																																																																				
YSD 125	12.5	YSD 126	12.6	YSD 127	12.7	YSD 128	12.8	YSD 129	12.9	YSD 130	13.0	YSD 131	13.1	YSD 132	13.2	YSD 133	13.3	YSD 134	13.4	YSD 135	13.5	YSD 136	13.6	YSD 137	13.7	YSD 138	13.8	YSD 139	13.9	YSD 140	14.0	YSD 141	14.1	YSD 142	14.2	YSD 143	14.3	YSD 144	14.4	YSD 145	14.5	YSD 146	14.6	YSD 147	14.7	YSD 148	14.8	YSD 149	14.9	YSD 150	15.0	YSD 151	15.1	YSD 152	15.2	YSD 153	15.3	YSD 154	15.4	YSD 155	15.5	YSD 156	15.6	YSD 157	15.7	YSD 158	15.8	YSD 159	15.9	YSD 160	16.0	YSD 161	16.1	YSD 163	16.3	YSD 164	16.4	YSD 165	16.5	YSD 166	16.6	YSD 167	16.7	YSD 168	16.8	YSD 169	16.9	YSD 170	17.0	YSD 171	17.1	YSD 172	17.2	YSD 173	17.3	YSD 174	17.4	YSD 175	17.5	YSD 176	17.6	YSD 177	17.7	YSD 178	17.8	YSD 179	17.9	YSD 180	18.0	YSD 181	18.1	YSD 182	18.2	YSD 183	18.3	YSD 184	18.4	YSD 185	18.5	YSD 186	18.6	YSD 187	18.7	YSD 188	18.8	YSD 189	18.9	YSD 190	19.0	YSD 191	19.1	YSD 192	19.2	YSD 193	19.3	YSD 194	19.4	YSD 195	19.5	YSD 196	19.6	YSD 197	19.7	YSD 198	19.8	YSD 199	19.9	YSD 200	20.0																																																																																																																																						
YSD 126	12.6	YSD 127	12.7	YSD 128	12.8	YSD 129	12.9	YSD 130	13.0	YSD 131	13.1	YSD 132	13.2	YSD 133	13.3	YSD 134	13.4	YSD 135	13.5	YSD 136	13.6	YSD 137	13.7	YSD 138	13.8	YSD 139	13.9	YSD 140	14.0	YSD 141	14.1	YSD 142	14.2	YSD 143	14.3	YSD 144	14.4	YSD 145	14.5	YSD 146	14.6	YSD 147	14.7	YSD 148	14.8	YSD 149	14.9	YSD 150	15.0	YSD 151	15.1	YSD 152	15.2	YSD 153	15.3	YSD 154	15.4	YSD 155	15.5	YSD 156	15.6	YSD 157	15.7	YSD 158	15.8	YSD 159	15.9	YSD 160	16.0	YSD 161	16.1	YSD 163	16.3	YSD 164	16.4	YSD 165	16.5	YSD 166	16.6	YSD 167	16.7	YSD 168	16.8	YSD 169	16.9	YSD 170	17.0	YSD 171	17.1	YSD 172	17.2	YSD 173	17.3	YSD 174	17.4	YSD 175	17.5	YSD 176	17.6	YSD 177	17.7	YSD 178	17.8	YSD 179	17.9	YSD 180	18.0	YSD 181	18.1	YSD 182	18.2	YSD 183	18.3	YSD 184	18.4	YSD 185	18.5	YSD 186	18.6	YSD 187	18.7	YSD 188	18.8	YSD 189	18.9	YSD 190	19.0	YSD 191	19.1	YSD 192	19.2	YSD 193	19.3	YSD 194	19.4	YSD 195	19.5	YSD 196	19.6	YSD 197	19.7	YSD 198	19.8	YSD 199	19.9	YSD 200	20.0																																																																																																																																								
YSD 127	12.7	YSD 128	12.8	YSD 129	12.9	YSD 130	13.0	YSD 131	13.1	YSD 132	13.2	YSD 133	13.3	YSD 134	13.4	YSD 135	13.5	YSD 136	13.6	YSD 137	13.7	YSD 138	13.8	YSD 139	13.9	YSD 140	14.0	YSD 141	14.1	YSD 142	14.2	YSD 143	14.3	YSD 144	14.4	YSD 145	14.5	YSD 146	14.6	YSD 147	14.7	YSD 148	14.8	YSD 149	14.9	YSD 150	15.0	YSD 151	15.1	YSD 152	15.2	YSD 153	15.3	YSD 154	15.4	YSD 155	15.5	YSD 156	15.6	YSD 157	15.7	YSD 158	15.8	YSD 159	15.9	YSD 160	16.0	YSD 161	16.1	YSD 163	16.3	YSD 164	16.4	YSD 165	16.5	YSD 166	16.6	YSD 167	16.7	YSD 168	16.8	YSD 169	16.9	YSD 170	17.0	YSD 171	17.1	YSD 172	17.2	YSD 173	17.3	YSD 174	17.4	YSD 175	17.5	YSD 176	17.6	YSD 177	17.7	YSD 178	17.8	YSD 179	17.9	YSD 180	18.0	YSD 181	18.1	YSD 182	18.2	YSD 183	18.3	YSD 184	18.4	YSD 185	18.5	YSD 186	18.6	YSD 187	18.7	YSD 188	18.8	YSD 189	18.9	YSD 190	19.0	YSD 191	19.1	YSD 192	19.2	YSD 193	19.3	YSD 194	19.4	YSD 195	19.5	YSD 196	19.6	YSD 197	19.7	YSD 198	19.8	YSD 199	19.9	YSD 200	20.0																																																																																																																																										
YSD 128	12.8	YSD 129	12.9	YSD 130	13.0	YSD 131	13.1	YSD 132	13.2	YSD 133	13.3	YSD 134	13.4	YSD 135	13.5	YSD 136	13.6	YSD 137	13.7	YSD 138	13.8	YSD 139	13.9	YSD 140	14.0	YSD 141	14.1	YSD 142	14.2	YSD 143	14.3	YSD 144	14.4	YSD 145	14.5	YSD 146	14.6	YSD 147	14.7	YSD 148	14.8	YSD 149	14.9	YSD 150	15.0	YSD 151	15.1	YSD 152	15.2	YSD 153	15.3	YSD 154	15.4	YSD 155	15.5	YSD 156	15.6	YSD 157	15.7	YSD 158	15.8	YSD 159	15.9	YSD 160	16.0	YSD 161	16.1	YSD 163	16.3	YSD 164	16.4	YSD 165	16.5	YSD 166	16.6	YSD 167	16.7	YSD 168	16.8	YSD 169	16.9	YSD 170	17.0	YSD 171	17.1	YSD 172	17.2	YSD 173	17.3	YSD 174	17.4	YSD 175	17.5	YSD 176	17.6	YSD 177	17.7	YSD 178	17.8	YSD 179	17.9	YSD 180	18.0	YSD 181	18.1	YSD 182	18.2	YSD 183	18.3	YSD 184	18.4	YSD 185	18.5	YSD 186	18.6	YSD 187	18.7	YSD 188	18.8	YSD 189	18.9	YSD 190	19.0	YSD 191	19.1	YSD 192	19.2	YSD 193	19.3	YSD 194	19.4	YSD 195	19.5	YSD 196	19.6	YSD 197	19.7	YSD 198	19.8	YSD 199	19.9	YSD 200	20.0																																																																																																																																												
YSD 129	12.9	YSD 130	13.0	YSD 131	13.1	YSD 132	13.2	YSD 133	13.3	YSD 134	13.4	YSD 135	13.5	YSD 136	13.6	YSD 137	13.7	YSD 138	13.8	YSD 139	13.9	YSD 140	14.0	YSD 141	14.1	YSD 142	14.2	YSD 143	14.3	YSD 144	14.4	YSD 145	14.5	YSD 146	14.6	YSD 147	14.7	YSD 148	14.8	YSD 149	14.9	YSD 150	15.0	YSD 151	15.1	YSD 152	15.2	YSD 153	15.3	YSD 154	15.4	YSD 155	15.5	YSD 156	15.6	YSD 157	15.7	YSD 158	15.8	YSD 159	15.9	YSD 160	16.0	YSD 161	16.1	YSD 163	16.3	YSD 164	16.4	YSD 165	16.5	YSD 166	16.6	YSD 167	16.7	YSD 168	16.8	YSD 169	16.9	YSD 170	17.0	YSD 171	17.1	YSD 172	17.2	YSD 173	17.3	YSD 174	17.4	YSD 175	17.5	YSD 176	17.6	YSD 177	17.7	YSD 178	17.8	YSD 179	17.9	YSD 180	18.0	YSD 181	18.1	YSD 182	18.2	YSD 183	18.3	YSD 184	18.4	YSD 185	18.5	YSD 186	18.6	YSD 187	18.7	YSD 188	18.8	YSD 189	18.9	YSD 190	19.0	YSD 191	19.1	YSD 192	19.2	YSD 193	19.3	YSD 194	19.4	YSD 195	19.5	YSD 196	19.6	YSD 197	19.7	YSD 198	19.8	YSD 199	19.9	YSD 200	20.0																																																																																																																																														
YSD 130	13.0	YSD 131	13.1	YSD 132	13.2	YSD 133	13.3	YSD 134	13.4	YSD 135	13.5	YSD 136	13.6	YSD 137	13.7	YSD 138	13.8	YSD 139	13.9	YSD 140	14.0	YSD 141	14.1	YSD 142	14.2	YSD 143	14.3	YSD 144	14.4	YSD 145	14.5	YSD 146	14.6	YSD 147	14.7	YSD 148	14.8	YSD 149	14.9	YSD 150	15.0	YSD 151	15.1	YSD 152	15.2	YSD 153	15.3	YSD 154	15.4	YSD 155	15.5	YSD 156	15.6	YSD 157	15.7	YSD 158	15.8	YSD 159	15.9	YSD 160	16.0	YSD 161	16.1	YSD 163	16.3	YSD 164	16.4	YSD 165	16.5	YSD 166	16.6	YSD 167	16.7	YSD 168	16.8	YSD 169	16.9	YSD 170	17.0	YSD 171	17.1	YSD 172	17.2	YSD 173	17.3	YSD 174	17.4	YSD 175	17.5	YSD 176	17.6	YSD 177	17.7	YSD 178	17.8	YSD 179	17.9	YSD 180	18.0	YSD 181	18.1	YSD 182	18.2	YSD 183	18.3	YSD 184	18.4	YSD 185	18.5	YSD 186	18.6	YSD 187	18.7	YSD 188	18.8	YSD 189	18.9	YSD 190	19.0	YSD 191	19.1	YSD 192	19.2	YSD 193	19.3	YSD 194	19.4	YSD 195	19.5	YSD 196	19.6	YSD 197	19.7	YSD 198	19.8	YSD 199	19.9	YSD 200	20.0																																																																																																																																																
YSD 131	13.1	YSD 132	13.2	YSD 133	13.3	YSD 134	13.4	YSD 135	13.5	YSD 136	13.6	YSD 137	13.7	YSD 138	13.8	YSD 139	13.9	YSD 140	14.0	YSD 141	14.1	YSD 142	14.2	YSD 143	14.3	YSD 144	14.4	YSD 145	14.5	YSD 146	14.6	YSD 147	14.7	YSD 148	14.8	YSD 149	14.9	YSD 150	15.0	YSD 151	15.1	YSD 152	15.2	YSD 153	15.3	YSD 154	15.4	YSD 155	15.5	YSD 156	15.6	YSD 157	15.7	YSD 158	15.8	YSD 159	15.9	YSD 160	16.0	YSD 161	16.1	YSD 163	16.3	YSD 164	16.4	YSD 165	16.5	YSD 166	16.6	YSD 167	16.7	YSD 168	16.8	YSD 169	16.9	YSD 170	17.0	YSD 171	17.1	YSD 172	17.2	YSD 173	17.3	YSD 174	17.4	YSD 175	17.5	YSD 176	17.6	YSD 177	17.7	YSD 178	17.8	YSD 179	17.9	YSD 180	18.0	YSD 181	18.1	YSD 182	18.2	YSD 183	18.3	YSD 184	18.4	YSD 185	18.5	YSD 186	18.6	YSD 187	18.7	YSD 188	18.8	YSD 189	18.9	YSD 190	19.0	YSD 191	19.1	YSD 192	19.2	YSD 193	19.3	YSD 194	19.4	YSD 195	19.5	YSD 196	19.6	YSD 197	19.7	YSD 198	19.8	YSD 199	19.9	YSD 200	20.0																																																																																																																																																		
YSD 132	13.2	YSD 133	13.3	YSD 134	13.4	YSD 135	13.5	YSD 136	13.6	YSD 137	13.7	YSD 138	13.8	YSD 139	13.9	YSD 140	14.0	YSD 141	14.1	YSD 142	14.2	YSD 143	14.3	YSD 144	14.4	YSD 145	14.5	YSD 146	14.6	YSD 147	14.7	YSD 148	14.8	YSD 149	14.9	YSD 150	15.0	YSD 151	15.1	YSD 152	15.2	YSD 153	15.3	YSD 154	15.4	YSD 155	15.5	YSD 156	15.6	YSD 157	15.7	YSD 158	15.8	YSD 159	15.9	YSD 160	16.0	YSD 161	16.1	YSD 163	16.3	YSD 164	16.4	YSD 165	16.5	YSD 166	16.6	YSD 167	16.7	YSD 168	16.8	YSD 169	16.9	YSD 170	17.0	YSD 171	17.1	YSD 172	17.2	YSD 173	17.3	YSD 174	17.4	YSD 175	17.5	YSD 176	17.6	YSD 177	17.7	YSD 178	17.8	YSD 179	17.9	YSD 180	18.0	YSD 181	18.1	YSD 182	18.2	YSD 183	18.3	YSD 184	18.4	YSD 185	18.5	YSD 186	18.6	YSD 187	18.7	YSD 188	18.8	YSD 189	18.9	YSD 190	19.0	YSD 191	19.1	YSD 192	19.2	YSD 193	19.3	YSD 194	19.4	YSD 195	19.5	YSD 196	19.6	YSD 197	19.7	YSD 198	19.8	YSD 199	19.9	YSD 200	20.0																																																																																																																																																				
YSD 133	13.3	YSD 134	13.4	YSD 135	13.5	YSD 136	13.6	YSD 137	13.7	YSD 138	13.8	YSD 139	13.9	YSD 140	14.0	YSD 141	14.1	YSD 142	14.2	YSD 143	14.3	YSD 144	14.4	YSD 145	14.5	YSD 146	14.6	YSD 147	14.7	YSD 148	14.8	YSD 149	14.9	YSD 150	15.0	YSD 151	15.1	YSD 152	15.2	YSD 153	15.3	YSD 154	15.4	YSD 155	15.5	YSD 156	15.6	YSD 157	15.7	YSD 158	15.8	YSD 159	15.9	YSD 160	16.0	YSD 161	16.1	YSD 163	16.3	YSD 164	16.4	YSD 165	16.5	YSD 166	16.6	YSD 167	16.7	YSD 168	16.8	YSD 169	16.9	YSD 170	17.0	YSD 171	17.1	YSD 172	17.2	YSD 173	17.3	YSD 174	17.4	YSD 175	17.5	YSD 176	17.6	YSD 177	17.7	YSD 178	17.8	YSD 179	17.9	YSD 180	18.0	YSD 181	18.1	YSD 182	18.2	YSD 183	18.3	YSD 184	18.4	YSD 185	18.5	YSD 186	18.6	YSD 187	18.7	YSD 188	18.8	YSD 189	18.9	YSD 190	19.0	YSD 191	19.1	YSD 192	19.2	YSD 193	19.3	YSD 194	19.4	YSD 195	19.5	YSD 196	19.6	YSD 197	19.7	YSD 198	19.8	YSD 199	19.9	YSD 200	20.0																																																																																																																																																						
YSD 134	13.4	YSD 135	13.5	YSD 136	13.6	YSD 137	13.7	YSD 138	13.8	YSD 139	13.9	YSD 140	14.0	YSD 141	14.1	YSD 142	14.2	YSD 143	14.3	YSD 144	14.4	YSD 145	14.5	YSD 146	14.6	YSD 147	14.7	YSD 148	14.8	YSD 149	14.9	YSD 150	15.0	YSD 151	15.1	YSD 152	15.2	YSD 153	15.3	YSD 154	15.4	YSD 155	15.5	YSD 156	15.6	YSD 157	15.7	YSD 158	15.8	YSD 159	15.9	YSD 160	16.0	YSD 161	16.1	YSD 163	16.3	YSD 164	16.4	YSD 165	16.5	YSD 166	16.6	YSD 167	16.7	YSD 168	16.8	YSD 169	16.9	YSD 170	17.0	YSD 171	17.1	YSD 172	17.2	YSD 173	17.3	YSD 174	17.4	YSD 175	17.5	YSD 176	17.6	YSD 177	17.7	YSD 178	17.8	YSD 179	17.9	YSD 180	18.0	YSD 181	18.1	YSD 182	18.2	YSD 183	18.3	YSD 184	18.4	YSD 185	18.5	YSD 186	18.6	YSD 187	18.7	YSD 188	18.8	YSD 189	18.9	YSD 190	19.0	YSD 191	19.1	YSD 192	19.2	YSD 193	19.3	YSD 194	19.4	YSD 195	19.5	YSD 196	19.6	YSD 197	19.7	YSD 198	19.8	YSD 199	19.9	YSD 200	20.0																																																																																																																																																								
YSD 135	13.5	YSD 136	13.6	YSD 137	13.7	YSD 138	13.8	YSD 139	13.9	YSD 140	14.0	YSD 141	14.1	YSD 142	14.2	YSD 143	14.3	YSD 144	14.4	YSD 145	14.5	YSD 146	14.6	YSD 147	14.7	YSD 148	14.8	YSD 149	14.9	YSD 150	15.0	YSD 151	15.1	YSD 152	15.2	YSD 153	15.3	YSD 154	15.4	YSD 155	15.5	YSD 156	15.6	YSD 157	15.7	YSD 158	15.8	YSD 159	15.9	YSD 160	16.0	YSD 161	16.1	YSD 163	16.3	YSD 164	16.4	YSD 165	16.5	YSD 166	16.6	YSD 167	16.7	YSD 168	16.8	YSD 169	16.9	YSD 170	17.0	YSD 171	17.1	YSD 172	17.2	YSD 173	17.3	YSD 174	17.4	YSD 175	17.5	YSD 176	17.6	YSD 177	17.7	YSD 178	17.8	YSD 179	17.9	YSD 180	18.0	YSD 181	18.1	YSD 182	18.2	YSD 183	18.3	YSD 184	18.4	YSD 185	18.5	YSD 186	18.6	YSD 187	18.7	YSD 188	18.8	YSD 189	18.9	YSD 190	19.0	YSD 191	19.1	YSD 192	19.2	YSD 193	19.3	YSD 194	19.4	YSD 195	19.5	YSD 196	19.6	YSD 197	19.7	YSD 198	19.8	YSD 199	19.9	YSD 200	20.0																																																																																																																																																										
YSD 136	13.6	YSD 137	13.7	YSD 138	13.8	YSD 139	13.9	YSD 140	14.0	YSD 141	14.1	YSD 142	14.2	YSD 143	14.3	YSD 144	14.4	YSD 145	14.5	YSD 146	14.6	YSD 147	14.7	YSD 148	14.8	YSD 149	14.9	YSD 150	15.0	YSD 151	15.1	YSD 152	15.2	YSD 153	15.3	YSD 154	15.4	YSD 155	15.5	YSD 156	15.6	YSD 157	15.7	YSD 158	15.8	YSD 159	15.9	YSD 160	16.0	YSD 161	16.1	YSD 163	16.3	YSD 164	16.4	YSD 165	16.5	YSD 166	16.6	YSD 167	16.7	YSD 168	16.8	YSD 169	16.9	YSD 170	17.0	YSD 171	17.1	YSD 172	17.2	YSD 173	17.3	YSD 174	17.4	YSD 175	17.5	YSD 176	17.6	YSD 177	17.7	YSD 178	17.8	YSD 179	17.9	YSD 180	18.0	YSD 181	18.1	YSD 182	18.2	YSD 183	18.3	YSD 184	18.4	YSD 185	18.5	YSD 186	18.6	YSD 187	18.7	YSD 188	18.8	YSD 189	18.9	YSD 190	19.0	YSD 191	19.1	YSD 192	19.2	YSD 193	19.3	YSD 194	19.4	YSD 195	19.5	YSD 196	19.6	YSD 197	19.7	YSD 198	19.8	YSD 199	19.9	YSD 200	20.0																																																																																																																																																												
YSD 137	13.7	YSD 138	13.8	YSD 139	13.9	YSD 140	14.0	YSD 141	14.1	YSD 142	14.2	YSD 143	14.3	YSD 144	14.4	YSD 145	14.5	YSD 146	14.6	YSD 147	14.7	YSD 148	14.8	YSD 149	14.9	YSD 150	15.0	YSD 151	15.1	YSD 152	15.2	YSD 153	15.3	YSD 154	15.4	YSD 155	15.5	YSD 156	15.6	YSD 157	15.7	YSD 158	15.8	YSD 159	15.9	YSD 160	16.0	YSD 161	16.1	YSD 163	16.3	YSD 164	16.4	YSD 165	16.5	YSD 166	16.6	YSD 167	16.7	YSD 168	16.8	YSD 169	16.9	YSD 170	17.0	YSD 171	17.1	YSD 172	17.2	YSD 173	17.3	YSD 174	17.4	YSD 175	17.5	YSD 176	17.6	YSD 177	17.7	YSD 178	17.8	YSD 179	17.9	YSD 180	18.0	YSD 181	18.1	YSD 182	18.2	YSD 183	18.3	YSD 184	18.4	YSD 185	18.5	YSD 186	18.6	YSD 187	18.7	YSD 188	18.8	YSD 189	18.9	YSD 190	19.0	YSD 191	19.1	YSD 192	19.2	YSD 193	19.3	YSD 194	19.4	YSD 195	19.5	YSD 196	19.6	YSD 197	19.7	YSD 198	19.8	YSD 199	19.9	YSD 200	20.0																																																																																																																																																														
YSD 138	13.8	YSD 139	13.9	YSD 140	14.0	YSD 141	14.1	YSD 142	14.2	YSD 143	14.3	YSD 144	14.4	YSD 145	14.5	YSD 146	14.6	YSD 147	14.7	YSD 148	14.8	YSD 149	14.9	YSD 150	15.0	YSD 151	15.1	YSD 152	15.2	YSD 153	15.3	YSD 154	15.4	YSD 155	15.5	YSD 156	15.6	YSD 157	15.7	YSD 158	15.8	YSD 159	15.9	YSD 160	16.0	YSD 161	16.1	YSD 163	16.3	YSD 164	16.4	YSD 165	16.5	YSD 166	16.6	YSD 167	16.7	YSD 168	16.8	YSD 169	16.9	YSD 170	17.0	YSD 171	17.1	YSD 172	17.2	YSD 173	17.3	YSD 174	17.4	YSD 175	17.5	YSD 176	17.6	YSD 177	17.7	YSD 178	17.8	YSD 179	17.9	YSD 180	18.0	YSD 181	18.1	YSD 182	18.2	YSD 183	18.3	YSD 184	18.4	YSD 185	18.5	YSD 186	18.6	YSD 187	18.7	YSD 188	18.8	YSD 189	18.9	YSD 190	19.0	YSD 191	19.1	YSD 192	19.2	YSD 193	19.3	YSD 194	19.4	YSD 195	19.5	YSD 196	19.6	YSD 197	19.7	YSD 198	19.8	YSD 199	19.9	YSD 200	20.0																																																																																																																																																																
YSD 139	13.9	YSD 140	14.0	YSD 141	14.1	YSD 142	14.2	YSD 143	14.3	YSD 144	14.4	YSD 145	14.5	YSD 146	14.6	YSD 147	14.7	YSD 148	14.8	YSD 149	14.9	YSD 150	15.0	YSD 151	15.1	YSD 152	15.2	YSD 153	15.3	YSD 154	15.4	YSD 155	15.5	YSD 156	15.6	YSD 157	15.7	YSD 158	15.8	YSD 159	15.9	YSD 160	16.0	YSD 161	16.1	YSD 163	16.3	YSD 164	16.4	YSD 165	16.5	YSD 166	16.6	YSD 167	16.7	YSD 168	16.8	YSD 169	16.9	YSD 170	17.0	YSD 171	17.1	YSD 172	17.2	YSD 173	17.3	YSD 174	17.4	YSD 175	17.5	YSD 176	17.6	YSD 177	17.7	YSD 178	17.8	YSD 179	17.9	YSD 180	18.0	YSD 181	18.1	YSD 182	18.2	YSD 183	18.3	YSD 184	18.4	YSD 185	18.5	YSD 186	18.6	YSD 187	18.7	YSD 188	18.8	YSD 189	18.9	YSD 190	19.0	YSD 191	19.1	YSD 192	19.2	YSD 193	19.3	YSD 194	19.4	YSD 195	19.5	YSD 196	19.6	YSD 197	19.7	YSD 198	19.8	YSD 199	19.9	YSD 200	20.0																																																																																																																																																																		
YSD 140	14.0	YSD 141	14.1	YSD 142	14.2	YSD 143	14.3	YSD 144	14.4	YSD 145	14.5	YSD 146	14.6	YSD 147	14.7	YSD 148	14.8	YSD 149	14.9	YSD 150	15.0	YSD 151	15.1	YSD 152	15.2	YSD 153	15.3	YSD 154	15.4	YSD 155	15.5	YSD 156	15.6	YSD 157	15.7	YSD 158	15.8	YSD 159	15.9	YSD 160	16.0	YSD 161	16.1	YSD 163	16.3	YSD 164	16.4	YSD 165	16.5	YSD 166	16.6	YSD 167	16.7	YSD 168	16.8	YSD 169	16.9	YSD 170	17.0	YSD 171	17.1	YSD 172	17.2	YSD 173	17.3	YSD 174	17.4	YSD 175	17.5	YSD 176	17.6	YSD 177	17.7	YSD 178	17.8	YSD 179	17.9	YSD 180	18.0	YSD 181	18.1	YSD 182	18.2	YSD 183	18.3	YSD 184	18.4	YSD 185	18.5	YSD 186	18.6	YSD 187	18.7	YSD 188	18.8	YSD 189	18.9	YSD 190	19.0	YSD 191	19.1	YSD 192	19.2	YSD 193	19.3	YSD 194	19.4	YSD 195	19.5	YSD 196	19.6	YSD 197	19.7	YSD 198	19.8	YSD 199	19.9	YSD 200	20.0																																																																																																																																																																				
YSD 141	14.1	YSD 142	14.2	YSD 143	14.3	YSD 144	14.4	YSD 145	14.5	YSD 146	14.6	YSD 147	14.7	YSD 148	14.8	YSD 149	14.9	YSD 150	15.0	YSD 151	15.1	YSD 152	15.2	YSD 153	15.3	YSD 154	15.4	YSD 155	15.5	YSD 156	15.6	YSD 157	15.7	YSD 158	15.8	YSD 159	15.9	YSD 160	16.0	YSD 161	16.1	YSD 163	16.3	YSD 164	16.4	YSD 165	16.5	YSD 166	16.6	YSD 167	16.7	YSD 168	16.8	YSD 169	16.9	YSD 170	17.0	YSD 171	17.1	YSD 172	17.2	YSD 173	17.3	YSD 174	17.4	YSD 175	17.5	YSD 176	17.6	YSD 177	17.7	YSD 178	17.8	YSD 179	17.9	YSD 180	18.0	YSD 181	18.1	YSD 182	18.2	YSD 183	18.3	YSD 184	18.4	YSD 185	18.5	YSD 186	18.6	YSD 187	18.7	YSD 188	18.8	YSD 189	18.9	YSD 190	19.0	YSD 191	19.1	YSD 192	19.2	YSD 193	19.3	YSD 194	19.4	YSD 195	19.5	YSD 196	19.6	YSD 197	19.7	YSD 198	19.8	YSD 199	19.9	YSD 200	20.0																																																																																																																																																																						
YSD 142	14.2	YSD 143	14.3	YSD 144	14.4	YSD 145	14.5	YSD 146	14.6	YSD 147	14.7	YSD 148	14.8	YSD 149	14.9	YSD 150	15.0	YSD 151	15.1	YSD 152	15.2	YSD 153	15.3	YSD 154	15.4	YSD 155	15.5	YSD 156	15.6	YSD 157	15.7	YSD 158	15.8	YSD 159	15.9	YSD 160	16.0	YSD 161	16.1	YSD 163	16.3	YSD 164	16.4	YSD 165	16.5	YSD 166	16.6	YSD 167	16.7	YSD 168	16.8	YSD 169	16.9	YSD 170	17.0	YSD 171	17.1	YSD 172	17.2	YSD 173	17.3	YSD 174	17.4	YSD 175	17.5	YSD 176	17.6	YSD 177	17.7	YSD 178	17.8	YSD 179	17.9	YSD 180	18.0	YSD 181	18.1	YSD 182	18.2	YSD 183	18.3	YSD 184	18.4	YSD 185	18.5	YSD 186	18.6	YSD 187	18.7	YSD 188	18.8	YSD 189	18.9	YSD 190	19.0	YSD 191	19.1	YSD 192	19.2	YSD 193	19.3	YSD 194	19.4	YSD 195	19.5	YSD 196	19.6	YSD 197	19.7	YSD 198	19.8	YSD 199	19.9	YSD 200	20.0																																																																																																																																																																								
YSD 143	14.3	YSD 144	14.4	YSD 145	14.5	YSD 146	14.6	YSD 147	14.7	YSD 148	14.8	YSD 149	14.9	YSD 150	15.0	YSD 151	15.1	YSD 152	15.2	YSD 153	15.3	YSD 154	15.4	YSD 155	15.5	YSD 156	15.6	YSD 157	15.7	YSD 158	15.8	YSD 159	15.9	YSD 160	16.0	YSD 161	16.1	YSD 163	16.3	YSD 164	16.4	YSD 165	16.5	YSD 166	16.6	YSD 167	16.7	YSD 168	16.8	YSD 169	16.9	YSD 170	17.0	YSD 171	17.1	YSD 172	17.2	YSD 173	17.3	YSD 174	17.4	YSD 175	17.5	YSD 176	17.6	YSD 177	17.7	YSD 178	17.8	YSD 179	17.9	YSD 180	18.0	YSD 181	18.1	YSD 182	18.2	YSD 183	18.3	YSD 184	18.4	YSD 185	18.5	YSD 186	18.6	YSD 187	18.7	YSD 188	18.8	YSD 189	18.9	YSD 190	19.0	YSD 191	19.1	YSD 192	19.2	YSD 193	19.3	YSD 194	19.4	YSD 195	19.5	YSD 196	19.6	YSD 197	19.7	YSD 198	19.8	YSD 199	19.9	YSD 200	20.0																																																																																																																																																																										
YSD 144	14.4	YSD 145	14.5	YSD 146	14.6	YSD 147	14.7	YSD 148	14.8	YSD 149	14.9	YSD 150	15.0	YSD 151	15.1	YSD 152	15.2	YSD 153	15.3	YSD 154	15.4	YSD 155	15.5	YSD 156	15.6	YSD 157	15.7	YSD 158	15.8	YSD 159	15.9	YSD 160	16.0	YSD 161	16.1	YSD 163	16.3	YSD 164	16.4	YSD 165	16.5	YSD 166	16.6	YSD 167	16.7	YSD 168	16.8	YSD 169	16.9	YSD 170	17.0	YSD 171	17.1	YSD 172	17.2	YSD 173	17.3	YSD 174	17.4	YSD 175	17.5	YSD 176	17.6	YSD 177	17.7	YSD 178	17.8	YSD 179	17.9	YSD 180	18.0	YSD 181	18.1	YSD 182	18.2	YSD 183	18.3	YSD 184	18.4	YSD 185	18.5	YSD 186	18.6	YSD 187	18.7	YSD 188	18.8	YSD 189	18.9	YSD 190	19.0	YSD 191	19.1	YSD 192	19.2	YSD 193	19.3	YSD 194	19.4	YSD 195	19.5	YSD 196	19.6	YSD 197	19.7	YSD 198	19.8	YSD 199	19.9	YSD 200	20.0																																																																																																																																																																												
YSD 145	14.5	YSD 146	14.6	YSD 147	14.7	YSD 148	14.8	YSD 149	14.9	YSD 150	15.0	YSD 151	15.1	YSD 152	15.2	YSD 153	15.3	YSD 154	15.4	YSD 155	15.5	YSD 156	15.6	YSD 157	15.7	YSD 158	15.8	YSD 159	15.9	YSD 160	16.0	YSD 161	16.1	YSD 163	16.3	YSD 164	16.4	YSD 165	16.5	YSD 166	16.6	YSD 167	16.7	YSD 168	16.8	YSD 169	16.9	YSD 170	17.0	YSD 171	17.1	YSD 172	17.2	YSD 173	17.3	YSD 174	17.4	YSD 175	17.5	YSD 176	17.6	YSD 177	17.7	YSD 178	17.8	YSD 179	17.9	YSD 180	18.0	YSD 181	18.1	YSD 182	18.2	YSD 183	18.3	YSD 184	18.4	YSD 185	18.5	YSD 186	18.6	YSD 187	18.7	YSD 188	18.8	YSD 189	18.9	YSD 190	19.0	YSD 191	19.1	YSD 192	19.2	YSD 193	19.3	YSD 194	19.4	YSD 195	19.5	YSD 196	19.6	YSD 197	19.7	YSD 198	19.8	YSD 199	19.9	YSD 200	20.0																																																																																																																																																																														
YSD 146	14.6	YSD 147	14.7	YSD 148	14.8	YSD 149	14.9	YSD 150	15.0	YSD 151	15.1	YSD 152	15.2	YSD 153	15.3	YSD 154	15.4	YSD 155	15.5	YSD 156	15.6	YSD 157	15.7	YSD 158	15.8	YSD 159	15.9	YSD 160	16.0	YSD 161	16.1	YSD 163	16.3	YSD 164	16.4	YSD 165	16.5	YSD 166	16.6	YSD 167	16.7	YSD 168	16.8	YSD 169	16.9	YSD 170	17.0	YSD 171	17.1	YSD 172	17.2	YSD 173	17.3	YSD 174	17.4	YSD 175	17.5	YSD 176	17.6	YSD 177	17.7	YSD 178	17.8	YSD 179	17.9	YSD 180	18.0	YSD 181	18.1	YSD 182	18.2	YSD 183	18.3	YSD 184	18.4	YSD 185	18.5	YSD 186	18.6	YSD 187	18.7	YSD 188	18.8	YSD 189	18.9	YSD 190	19.0	YSD 191	19.1	YSD 192	19.2	YSD 193	19.3	YSD 194	19.4	YSD 195	19.5	YSD 196	19.6	YSD 197	19.7	YSD 198	19.8	YSD 199	19.9	YSD 200	20.0																																																																																																																																																																																
YSD 147	14.7	YSD 148	14.8	YSD 149	14.9	YSD 150	15.0	YSD 151	15.1	YSD 152	15.2	YSD 153	15.3	YSD 154	15.4	YSD 155	15.5	YSD 156	15.6	YSD 157	15.7	YSD 158	15.8	YSD 159	15.9	YSD 160	16.0	YSD 161	16.1	YSD 163	16.3	YSD 164	16.4	YSD 165	16.5	YSD 166	16.6	YSD 167	16.7	YSD 168	16.8	YSD 169	16.9	YSD 170	17.0	YSD 171	17.1	YSD 172	17.2	YSD 173	17.3	YSD 174	17.4	YSD 175	17.5	YSD 176	17.6	YSD 177	17.7	YSD 178	17.8	YSD 179	17.9	YSD 180	18.0	YSD 181	18.1	YSD 182	18.2	YSD 183	18.3	YSD 184	18.4	YSD 185	18.5	YSD 186	18.6	YSD 187	18.7	YSD 188	18.8	YSD 189	18.9	YSD 190	19.0	YSD 191	19.1	YSD 192	19.2	YSD 193	19.3	YSD 194	19.4	YSD 195	19.5	YSD 196	19.6	YSD 197	19.7	YSD 198	19.8	YSD 199	19.9	YSD 200	20.0																																																																																																																																																																																		
YSD 148	14.8	YSD 149	14.9	YSD 150	15.0	YSD 151	15.1	YSD 152	15.2	YSD 153	15.3	YSD 154	15.4	YSD 155	15.5	YSD 156	15.6	YSD 157	15.7	YSD 158	15.8	YSD 159	15.9	YSD 160	16.0	YSD 161	16.1	YSD 163	16.3	YSD 164	16.4	YSD 165	16.5	YSD 166	16.6	YSD 167	16.7	YSD 168	16.8	YSD 169	16.9	YSD 170	17.0	YSD 171	17.1	YSD 172	17.2	YSD 173	17.3	YSD 174	17.4	YSD 175	17.5	YSD 176	17.6	YSD 177	17.7	YSD 178	17.8	YSD 179	17.9	YSD 180	18.0	YSD 181	18.1	YSD 182	18.2	YSD 183	18.3	YSD 184	18.4	YSD 185	18.5	YSD 186	18.6	YSD 187	18.7	YSD 188	18.8	YSD 189	18.9	YSD 190	19.0	YSD 191	19.1	YSD 192	19.2	YSD 193	19.3	YSD 194	19.4	YSD 195	19.5	YSD 196	19.6	YSD 197	19.7	YSD 198	19.8	YSD 199	19.9	YSD 200	20.0																																																																																																																																																																																				
YSD 149	14.9	YSD 150	15.0	YSD 151	15.1	YSD 152	15.2	YSD 153	15.3	YSD 154	15.4	YSD 155	15.5	YSD 156	15.6	YSD 157	15.7	YSD 158	15.8	YSD 159	15.9	YSD 160	16.0	YSD 161	16.1	YSD 163	16.3	YSD 164	16.4	YSD 165	16.5	YSD 166	16.6	YSD 167	16.7	YSD 168	16.8	YSD 169	16.9	YSD 170	17.0	YSD 171	17.1	YSD 172	17.2	YSD 173	17.3	YSD 174	17.4	YSD 175	17.5	YSD 176	17.6	YSD 177	17.7	YSD 178	17.8	YSD 179	17.9	YSD 180	18.0	YSD 181	18.1	YSD 182	18.2	YSD 183	18.3	YSD 184	18.4	YSD 185	18.5	YSD 186	18.6	YSD 187	18.7	YSD 188	18.8	YSD 189	18.9	YSD 190	19.0	YSD 191	19.1	YSD 192	19.2	YSD 193	19.3	YSD 194	19.4	YSD 195	19.5	YSD 196	19.6	YSD 197	19.7	YSD 198	19.8	YSD 199	19.9	YSD 200	20.0																																																																																																																																																																																						
YSD 150	15.0	YSD 151	15.1	YSD 152	15.2	YSD 153	15.3	YSD 154	15.4	YSD 155	15.5	YSD 156	15.6	YSD 157	15.7	YSD 158	15.8	YSD 159	15.9	YSD 160	16.0	YSD 161	16.1	YSD 163	16.3	YSD 164	16.4	YSD 165	16.5	YSD 166	16.6	YSD 167	16.7	YSD 168	16.8	YSD 169	16.9	YSD 170	17.0	YSD 171	17.1	YSD 172	17.2	YSD 173	17.3	YSD 174	17.4	YSD 175	17.5	YSD 176	17.6	YSD 177	17.7	YSD 178	17.8	YSD 179	17.9	YSD 180	18.0	YSD 181	18.1	YSD 182	18.2	YSD 183	18.3	YSD 184	18.4	YSD 185	18.5	YSD 186	18.6	YSD 187	18.7	YSD 188	18.8	YSD 189	18.9	YSD 190	19.0	YSD 191	19.1	YSD 192	19.2	YSD 193	19.3	YSD 194	19.4	YSD 195	19.5	YSD 196	19.6	YSD 197	19.7	YSD 198	19.8	YSD 199	19.9	YSD 200	20.0																																																																																																																																																																																								
YSD 151	15.1	YSD 152	15.2	YSD 153	15.3	YSD 154	15.4	YSD 155	15.5	YSD 156	15.6	YSD 157	15.7	YSD 158	15.8	YSD 159	15.9	YSD 160	16.0	YSD 161	16.1	YSD 163	16.3	YSD 164	16.4	YSD 165	16.5	YSD 166	16.6	YSD 167	16.7	YSD 168	16.8	YSD 169	16.9	YSD 170	17.0	YSD 171	17.1	YSD 172	17.2	YSD 173	17.3	YSD 174	17.4	YSD 175	17.5	YSD 176	17.6	YSD 177	17.7	YSD 178	17.8	YSD 179	17.9	YSD 180	18.0	YSD 181	18.1	YSD 182	18.2	YSD 183	18.3	YSD 184	18.4	YSD 185	18.5	YSD 186	18.6	YSD 187	18.7	YSD 188	18.8	YSD 189	18.9	YSD 190	19.0	YSD 191	19.1	YSD 192	19.2	YSD 193	19.3	YSD 194	19.4	YSD 195	19.5	YSD 196	19.6	YSD 197	19.7	YSD 198	19.8	YSD 199	19.9	YSD 200	20.0																																																																																																																																																																																										
YSD 152	15.2	YSD 153	15.3	YSD 154	15.4	YSD 155	15.5	YSD 156	15.6	YSD 157	15.7	YSD 158	15.8	YSD 159	15.9	YSD 160	16.0	YSD 161	16.1	YSD 163	16.3	YSD 164	16.4	YSD 165	16.5	YSD 166	16.6	YSD 167	16.7	YSD 168	16.8	YSD 169	16.9	YSD 170	17.0	YSD 171	17.1	YSD 172	17.2	YSD 173	17.3	YSD 174	17.4	YSD 175	17.5	YSD 176	17.6	YSD 177	17.7	YSD 178	17.8	YSD 179	17.9	YSD 180	18.0	YSD 181	18.1	YSD 182	18.2	YSD 183	18.3	YSD 184	18.4	YSD 185	18.5	YSD 186	18.6	YSD 187	18.7	YSD 188	18.8	YSD 189	18.9	YSD 190	19.0	YSD 191	19.1	YSD 192	19.2	YSD 193	19.3	YSD 194	19.4	YSD 195	19.5	YSD 196	19.6	YSD 197	19.7	YSD 198	19.8	YSD 199	19.9	YSD 200	20.0																																																																																																																																																																																												
YSD 153	15.3	YSD 154	15.4	YSD 155	15.5	YSD 156	15.6	YSD 157	15.7	YSD 158	15.8	YSD 159	15.9	YSD 160	16.0	YSD 161	16.1	YSD 163	16.3	YSD 164	16.4	YSD 165	16.5	YSD 166	16.6	YSD 167	16.7	YSD 168	16.8	YSD 169	16.9	YSD 170	17.0	YSD 171	17.1	YSD 172	17.2	YSD 173	17.3	YSD 174	17.4	YSD 175	17.5	YSD 176	17.6	YSD 177	17.7	YSD 178	17.8	YSD 179	17.9	YSD 180	18.0	YSD 181	18.1	YSD 182	18.2	YSD 183	18.3	YSD 184	18.4	YSD 185	18.5	YSD 186	18.6	YSD 187	18.7	YSD 188	18.8	YSD 189	18.9	YSD 190	19.0	YSD 191	19.1	YSD 192	19.2	YSD 193	19.3	YSD 194	19.4	YSD 195	19.5	YSD 196	19.6	YSD 197	19.7	YSD 198	19.8	YSD 199	19.9	YSD 200	20.0																																																																																																																																																																																														
YSD 154	15.4	YSD 155	15.5	YSD 156	15.6	YSD 157	15.7	YSD 158	15.8	YSD 159	15.9	YSD 160	16.0	YSD 161	16.1	YSD 163	16.3	YSD 164	16.4	YSD 165	16.5	YSD 166	16.6	YSD 167	16.7	YSD 168	16.8	YSD 169	16.9	YSD 170	17.0	YSD 171	17.1	YSD 172	17.2	YSD 173	17.3	YSD 174	17.4	YSD 175	17.5	YSD 176	17.6	YSD 177	17.7	YSD 178	17.8	YSD 179	17.9	YSD 180	18.0	YSD 181	18.1	YSD 182	18.2	YSD 183	18.3	YSD 184	18.4	YSD 185	18.5	YSD 186	18.6	YSD 187	18.7	YSD 188	18.8	YSD 189	18.9	YSD 190	19.0	YSD 191	19.1	YSD 192	19.2	YSD 193	19.3	YSD 194	19.4	YSD 195	19.5	YSD 196	19.6	YSD 197	19.7	YSD 198	19.8	YSD 199	19.9	YSD 200	20.0																																																																																																																																																																																																
YSD 155	15.5	YSD 156	15.6	YSD 157	15.7	YSD 158	15.8	YSD 159	15.9	YSD 160	16.0	YSD 161	16.1	YSD 163	16.3	YSD 164	16.4	YSD 165	16.5	YSD 166	16.6	YSD 167	16.7	YSD 168	16.8	YSD 169	16.9	YSD 170	17.0	YSD 171	17.1	YSD 172	17.2	YSD 173	17.3	YSD 174	17.4	YSD 175	17.5	YSD 176	17.6	YSD 177	17.7	YSD 178	17.8	YSD 179	17.9	YSD 180	18.0	YSD 181	18.1	YSD 182	18.2	YSD 183	18.3	YSD 184	18.4	YSD 185	18.5	YSD 186	18.6	YSD 187	18.7	YSD 188	18.8	YSD 189	18.9	YSD 190	19.0	YSD 191	19.1	YSD 192	19.2	YSD 193	19.3	YSD 194	19.4	YSD 195	19.5	YSD 196	19.6	YSD 197	19.7	YSD 198	19.8	YSD 199	19.9	YSD 200	20.0																																																																																																																																																																																																		
YSD 156	15.6	YSD 157	15.7	YSD 158	15.8	YSD 159	15.9	YSD 160	16.0	YSD 161	16.1	YSD 163	16.3	YSD 164	16.4	YSD 165	16.5	YSD 166	16.6	YSD 167	16.7	YSD 168	16.8	YSD 169	16.9	YSD 170	17.0	YSD 171	17.1	YSD 172	17.2	YSD 173	17.3	YSD 174	17.4	YSD 175	17.5	YSD 176	17.6	YSD 177	17.7	YSD 178	17.8	YSD 179	17.9	YSD 180	18.0	YSD 181	18.1	YSD 182	18.2	YSD 183	18.3	YSD 184	18.4	YSD 185	18.5	YSD 186	18.6	YSD 187	18.7	YSD 188	18.8	YSD 189	18.9	YSD 190	19.0	YSD 191	19.1	YSD 192	19.2	YSD 193	19.3	YSD 194	19.4	YSD 195	19.5	YSD 196	19.6	YSD 197	19.7	YSD 198	19.8	YSD 199	19.9	YSD 200	20.0																																																																																																																																																																																																				
YSD 157	15.7	YSD 158	15.8	YSD 159	15.9	YSD 160	16.0	YSD 161	16.1	YSD 163	16.3	YSD 164	16.4	YSD 165	16.5	YSD 166	16.6	YSD 167	16.7	YSD 168	16.8	YSD 169	16.9	YSD 170	17.0	YSD 171	17.1	YSD 172	17.2	YSD 173	17.3	YSD 174	17.4	YSD 175	17.5	YSD 176	17.6	YSD 177	17.7	YSD 178	17.8	YSD 179	17.9	YSD 180	18.0	YSD 181	18.1	YSD 182	18.2	YSD 183	18.3	YSD 184	18.4	YSD 185	18.5	YSD 186	18.6	YSD 187	18.7	YSD 188	18.8	YSD 189	18.9	YSD 190	19.0	YSD 191	19.1	YSD 192	19.2	YSD 193	19.3	YSD 194	19.4	YSD 195	19.5	YSD 196	19.6	YSD 197	19.7	YSD 198	19.8	YSD 199	19.9	YSD 200	20.0																																																																																																																																																																																																						
YSD 158	15.8	YSD 159	15.9	YSD 160	16.0	YSD 161	16.1	YSD 163	16.3	YSD 164	16.4	YSD 165	16.5	YSD 166	16.6	YSD 167	16.7	YSD 168	16.8	YSD 169	16.9	YSD 170	17.0	YSD 171	17.1	YSD 172	17.2	YSD 173	17.3	YSD 174	17.4	YSD 175	17.5	YSD 176	17.6	YSD 177	17.7	YSD 178	17.8	YSD 179	17.9	YSD 180	18.0	YSD 181	18.1	YSD 182	18.2	YSD 183	18.3	YSD 184	18.4	YSD 185	18.5	YSD 186	18.6	YSD 187	18.7	YSD 188	18.8	YSD 189	18.9	YSD 190	19.0	YSD 191	19.1	YSD 192	19.2	YSD 193	19.3	YSD 194	19.4	YSD 195	19.5	YSD 196	19.6	YSD 197	19.7	YSD 198	19.8	YSD 199	19.9	YSD 200	20.0																																																																																																																																																																																																								
YSD 159	15.9	YSD 160	16.0	YSD 161	16.1	YSD 163	16.3	YSD 164	16.4	YSD 165	16.5	YSD 166	16.6	YSD 167	16.7	YSD 168	16.8	YSD 169	16.9	YSD 170	17.0	YSD 171	17.1	YSD 172	17.2	YSD 173	17.3	YSD 174	17.4	YSD 175	17.5	YSD 176	17.6	YSD 177	17.7	YSD 178	17.8	YSD 179	17.9	YSD 180	18.0	YSD 181	18.1	YSD 182	18.2	YSD 183	18.3	YSD 184	18.4	YSD 185	18.5	YSD 186	18.6	YSD 187	18.7	YSD 188	18.8	YSD 189	18.9	YSD 190	19.0	YSD 191	19.1	YSD 192	19.2	YSD 193	19.3	YSD 194	19.4	YSD 195	19.5	YSD 196	19.6	YSD 197	19.7	YSD 198	19.8	YSD 199	19.9	YSD 200	20.0																																																																																																																																																																																																										
YSD 160	16.0	YSD 161	16.1	YSD 163	16.3	YSD 164	16.4	YSD 165	16.5	YSD 166	16.6	YSD 167	16.7	YSD 168	16.8	YSD 169	16.9	YSD 170	17.0	YSD 171	17.1	YSD 172	17.2	YSD 173	17.3	YSD 174	17.4	YSD 175	17.5	YSD 176	17.6	YSD 177	17.7	YSD 178	17.8	YSD 179	17.9	YSD 180	18.0	YSD 181	18.1	YSD 182	18.2	YSD 183	18.3	YSD 184	18.4	YSD 185	18.5	YSD 186	18.6	YSD 187	18.7	YSD 188	18.8	YSD 189	18.9	YSD 190	19.0	YSD 191	19.1	YSD 192	19.2	YSD 193	19.3	YSD 194	19.4	YSD 195	19.5	YSD 196	19.6	YSD 197	19.7	YSD 198	19.8	YSD 199	19.9	YSD 200	20.0																																																																																																																																																																																																												
YSD 161	16.1	YSD 163	16.3	YSD 164	16.4	YSD 165	16.5	YSD 166	16.6	YSD 167	16.7	YSD 168	16.8	YSD 169	16.9	YSD 170	17.0	YSD 171	17.1	YSD 172	17.2	YSD 173	17.3	YSD 174	17.4	YSD 175	17.5	YSD 176	17.6	YSD 177	17.7	YSD 178	17.8	YSD 179	17.9	YSD 180	18.0	YSD 181	18.1	YSD 182	18.2	YSD 183	18.3	YSD 184	18.4	YSD 185	18.5	YSD 186	18.6	YSD 187	18.7	YSD 188	18.8	YSD 189	18.9	YSD 190	19.0	YSD 191	19.1	YSD 192	19.2	YSD 193	19.3	YSD 194	19.4	YSD 195	19.5	YSD 196	19.6	YSD 197	19.7	YSD 198	19.8	YSD 199	19.9	YSD 200	20.0																																																																																																																																																																																																														
YSD 163	16.3	YSD 164	16.4	YSD 165	16.5	YSD 166	16.6	YSD 167	16.7	YSD 168	16.8	YSD 169	16.9	YSD 170	17.0	YSD 171	17.1	YSD 172	17.2	YSD 173	17.3	YSD 174	17.4	YSD 175	17.5	YSD 176	17.6	YSD 177	17.7	YSD 178	17.8	YSD 179	17.9	YSD 180	18.0	YSD 181	18.1	YSD 182	18.2	YSD 183	18.3	YSD 184	18.4	YSD 185	18.5	YSD 186	18.6	YSD 187	18.7	YSD 188	18.8	YSD 189	18.9	YSD 190	19.0	YSD 191	19.1	YSD 192	19.2	YSD 193	19.3	YSD 194	19.4	YSD 195	19.5	YSD 196	19.6	YSD 197	19.7	YSD 198	19.8	YSD 199	19.9	YSD 200	20.0																																																																																																																																																																																																																
YSD 164	16.4	YSD 165	16.5	YSD 166	16.6	YSD 167	16.7	YSD 168	16.8	YSD 169	16.9	YSD 170	17.0	YSD 171	17.1	YSD 172	17.2	YSD 173	17.3	YSD 174	17.4	YSD 175	17.5	YSD 176	17.6	YSD 177	17.7	YSD 178	17.8	YSD 179	17.9	YSD 180	18.0	YSD 181	18.1	YSD 182	18.2	YSD 183	18.3	YSD 184	18.4	YSD 185	18.5	YSD 186	18.6	YSD 187	18.7	YSD 188	18.8	YSD 189	18.9	YSD 190	19.0	YSD 191	19.1	YSD 192	19.2	YSD 193	19.3	YSD 194	19.4	YSD 195	19.5	YSD 196	19.6	YSD 197	19.7	YSD 198	19.8	YSD 199	19.9	YSD 200	20.0																																																																																																																																																																																																																		
YSD 165	16.5	YSD 166	16.6	YSD 167	16.7	YSD 168	16.8	YSD 169	16.9	YSD 170	17.0	YSD 171	17.1	YSD 172	17.2	YSD 173	17.3	YSD 174	17.4	YSD 175	17.5	YSD 176	17.6	YSD 177	17.7	YSD 178	17.8	YSD 179	17.9	YSD 180	18.0	YSD 181	18.1	YSD 182	18.2	YSD 183	18.3	YSD 184	18.4	YSD 185	18.5	YSD 186	18.6	YSD 187	18.7	YSD 188	18.8	YSD 189	18.9	YSD 190	19.0	YSD 191	19.1	YSD 192	19.2	YSD 193	19.3	YSD 194	19.4	YSD 195	19.5	YSD 196	19.6	YSD 197	19.7	YSD 198	19.8	YSD 199	19.9	YSD 200	20.0																																																																																																																																																																																																																				
YSD 166	16.6	YSD 167	16.7	YSD 168	16.8	YSD 169	16.9	YSD 170	17.0	YSD 171	17.1	YSD 172	17.2	YSD 173	17.3	YSD 174	17.4	YSD 175	17.5	YSD 176	17.6	YSD 177	17.7	YSD 178	17.8	YSD 179	17.9	YSD 180	18.0	YSD 181	18.1	YSD 182	18.2	YSD 183	18.3	YSD 184	18.4	YSD 185	18.5	YSD 186	18.6	YSD 187	18.7	YSD 188	18.8	YSD 189	18.9	YSD 190	19.0	YSD 191	19.1	YSD 192	19.2	YSD 193	19.3	YSD 194	19.4	YSD 195	19.5	YSD 196	19.6	YSD 197	19.7	YSD 198	19.8	YSD 199	19.9	YSD 200	20.0																																																																																																																																																																																																																						
YSD 167	16.7	YSD 168	16.8	YSD 169	16.9	YSD 170	17.0	YSD 171	17.1	YSD 172	17.2	YSD 173	17.3	YSD 174	17.4	YSD 175	17.5	YSD 176	17.6	YSD 177	17.7	YSD 178	17.8	YSD 179	17.9	YSD 180	18.0	YSD 181	18.1	YSD 182	18.2	YSD 183	18.3	YSD 184	18.4	YSD 185	18.5	YSD 186	18.6	YSD 187	18.7	YSD 188	18.8	YSD 189	18.9	YSD 190	19.0	YSD 191	19.1	YSD 192	19.2	YSD 193	19.3	YSD 194	19.4	YSD 195	19.5	YSD 196	19.6	YSD 197	19.7	YSD 198	19.8	YSD 199	19.9	YSD 200	20.0																																																																																																																																																																																																																								
YSD 168	16.8	YSD 169	16.9	YSD 170	17.0	YSD 171	17.1	YSD 172	17.2	YSD 173	17.3	YSD 174	17.4	YSD 175	17.5	YSD 176	17.6	YSD 177	17.7	YSD 178	17.8	YSD 179	17.9	YSD 180	18.0	YSD 181	18.1	YSD 182	18.2	YSD 183	18.3	YSD 184	18.4	YSD 185	18.5	YSD 186	18.6	YSD 187	18.7	YSD 188	18.8	YSD 189	18.9	YSD 190	19.0	YSD 191	19.1	YSD 192	19.2	YSD 193	19.3	YSD 194	19.4	YSD 195	19.5	YSD 196	19.6	YSD 197	19.7	YSD 198	19.8	YSD 199	19.9	YSD 200	20.0																																																																																																																																																																																																																										
YSD 169	16.9	YSD 170	17.0	YSD 171	17.1	YSD 172	17.2	YSD 173	17.3	YSD 174	17.4	YSD 175	17.5	YSD 176	17.6	YSD 177	17.7	YSD 178	17.8	YSD 179	17.9	YSD 180	18.0	YSD 181	18.1	YSD 182	18.2	YSD 183	18.3	YSD 184	18.4	YSD 185	18.5	YSD 186	18.6	YSD 187	18.7	YSD 188	18.8	YSD 189	18.9	YSD 190	19.0	YSD 191	19.1	YSD 192	19.2	YSD 193	19.3	YSD 194	19.4	YSD 195	19.5	YSD 196	19.6	YSD 197	19.7	YSD 198	19.8	YSD 199	19.9	YSD 200	20.0																																																																																																																																																																																																																												
YSD 170	17.0	YSD 171	17.1	YSD 172	17.2	YSD 173	17.3	YSD 174	17.4	YSD 175	17.5	YSD 176	17.6	YSD 177	17.7	YSD 178	17.8	YSD 179	17.9	YSD 180	18.0	YSD 181	18.1	YSD 182	18.2	YSD 183	18.3	YSD 184	18.4	YSD 185	18.5	YSD 186	18.6	YSD 187	18.7	YSD 188	18.8	YSD 189	18.9	YSD 190	19.0	YSD 191	19.1	YSD 192	19.2	YSD 193	19.3	YSD 194	19.4	YSD 195	19.5	YSD 196	19.6	YSD 197	19.7	YSD 198	19.8	YSD 199	19.9	YSD 200	20.0																																																																																																																																																																																																																														
YSD 171	17.1	YSD 172	17.2	YSD 173	17.3	YSD 174	17.4	YSD 175	17.5	YSD 176	17.6	YSD 177	17.7	YSD 178	17.8	YSD 179	17.9	YSD 180	18.0	YSD 181	18.1	YSD 182	18.2	YSD 183	18.3	YSD 184	18.4	YSD 185	18.5	YSD 186	18.6	YSD 187	18.7	YSD 188	18.8	YSD 189	18.9	YSD 190	19.0	YSD 191	19.1	YSD 192	19.2	YSD 193	19.3	YSD 194	19.4	YSD 195	19.5	YSD 196	19.6	YSD 197	19.7	YSD 198	19.8	YSD 199	19.9	YSD 200	20.0																																																																																																																																																																																																																																
YSD 172	17.2	YSD 173	17.3	YSD 174	17.4	YSD 175	17.5	YSD 176	17.6	YSD 177	17.7	YSD 178	17.8	YSD 179	17.9	YSD 180	18.0	YSD 181	18.1	YSD 182	18.2	YSD 183	18.3	YSD 184	18.4	YSD 185	18.5	YSD 186	18.6	YSD 187	18.7	YSD 188	18.8	YSD 189	18.9	YSD 190	19.0	YSD 191	19.1	YSD 192	19.2	YSD 193	19.3	YSD 194	19.4	YSD 195	19.5	YSD 196	19.6	YSD 197	19.7	YSD 198	19.8	YSD 199	19.9	YSD 200	20.0																																																																																																																																																																																																																																		
YSD 173	17.3	YSD 174	17.4	YSD 175	17.5	YSD 176	17.6	YSD 177	17.7	YSD 178	17.8	YSD 179	17.9	YSD 180	18.0	YSD 181	18.1	YSD 182	18.2	YSD 183	18.3	YSD 184	18.4	YSD 185	18.5	YSD 186	18.6	YSD 187	18.7	YSD 188	18.8	YSD 189	18.9	YSD 190	19.0	YSD 191	19.1	YSD 192	19.2	YSD 193	19.3	YSD 194	19.4	YSD 195	19.5	YSD 196	19.6	YSD 197	19.7	YSD 198	19.8	YSD 199	19.9	YSD 200	20.0																																																																																																																																																																																																																																				
YSD 174	17.4	YSD 175	17.5	YSD 176	17.6	YSD 177	17.7	YSD 178	17.8	YSD 179	17.9	YSD 180	18.0	YSD 181	18.1	YSD 182	18.2	YSD 183	18.3	YSD 184	18.4	YSD 185	18.5	YSD 186	18.6	YSD 187	18.7	YSD 188	18.8	YSD 189	18.9	YSD 190	19.0	YSD 191	19.1	YSD 192	19.2	YSD 193	19.3	YSD 194	19.4	YSD 195	19.5	YSD 196	19.6	YSD 197	19.7	YSD 198	19.8	YSD 199	19.9	YSD 200	20.0																																																																																																																																																																																																																																						
YSD 175	17.5	YSD 176	17.6	YSD 177	17.7	YSD 178	17.8	YSD 179	17.9	YSD 180	18.0	YSD 181	18.1	YSD 182	18.2	YSD 183	18.3	YSD 184	18.4	YSD 185	18.5	YSD 186	18.6	YSD 187	18.7	YSD 188	18.8	YSD 189	18.9	YSD 190	19.0	YSD 191	19.1	YSD 192	19.2	YSD 193	19.3	YSD 194	19.4	YSD 195	19.5	YSD 196	19.6	YSD 197	19.7	YSD 198	19.8	YSD 199	19.9	YSD 200	20.0																																																																																																																																																																																																																																								
YSD 176	17.6	YSD 177	17.7	YSD 178	17.8	YSD 179	17.9	YSD 180	18.0	YSD 181	18.1	YSD 182	18.2	YSD 183	18.3	YSD 184	18.4	YSD 185	18.5	YSD 186	18.6	YSD 187	18.7	YSD 188	18.8	YSD 189	18.9	YSD 190	19.0	YSD 191	19.1	YSD 192	19.2	YSD 193	19.3	YSD 194	19.4	YSD 195	19.5	YSD 196	19.6	YSD 197	19.7	YSD 198	19.8	YSD 199	19.9	YSD 200	20.0																																																																																																																																																																																																																																										
YSD 177	17.7	YSD 178	17.8	YSD 179	17.9	YSD 180	18.0	YSD 181	18.1	YSD 182	18.2	YSD 183	18.3	YSD 184	18.4	YSD 185	18.5	YSD 186	18.6	YSD 187	18.7	YSD 188	18.8	YSD 189	18.9	YSD 190	19.0	YSD 191	19.1	YSD 192	19.2	YSD 193	19.3	YSD 194	19.4	YSD 195	19.5	YSD 196	19.6	YSD 197	19.7	YSD 198	19.8	YSD 199	19.9	YSD 200	20.0																																																																																																																																																																																																																																												
YSD 178	17.8	YSD 179	17.9	YSD 180	18.0	YSD 181	18.1	YSD 182	18.2	YSD 183	18.3	YSD 184	18.4	YSD 185	18.5	YSD 186	18.6	YSD 187	18.7	YSD 188	18.8	YSD 189	18.9	YSD 190	19.0	YSD 191	19.1	YSD 192	19.2	YSD 193	19.3	YSD 194	19.4	YSD 195	19.5	YSD 196	19.6	YSD 197	19.7	YSD 198	19.8	YSD 199	19.9	YSD 200	20.0																																																																																																																																																																																																																																														
YSD 179	17.9	YSD 180	18.0	YSD 181	18.1	YSD 182	18.2	YSD 183	18.3	YSD 184	18.4	YSD 185	18.5	YSD 186	18.6	YSD 187	18.7	YSD 188	18.8	YSD 189	18.9	YSD 190	19.0	YSD 191	19.1	YSD 192	19.2	YSD 193	19.3	YSD 194	19.4	YSD 195	19.5	YSD 196	19.6	YSD 197	19.7	YSD 198	19.8	YSD 199	19.9	YSD 200	20.0																																																																																																																																																																																																																																																
YSD 180	18.0	YSD 181	18.1	YSD 182	18.2	YSD 183	18.3	YSD 184	18.4	YSD 185	18.5	YSD 186	18.6	YSD 187	18.7	YSD 188	18.8	YSD 189	18.9	YSD 190	19.0	YSD 191	19.1	YSD 192	19.2	YSD 193	19.3	YSD 194	19.4	YSD 195	19.5	YSD 196	19.6	YSD 197	19.7	YSD 198	19.8	YSD 199	19.9	YSD 200	20.0																																																																																																																																																																																																																																																		
YSD 181	18.1	YSD 182	18.2	YSD 183	18.3	YSD 184	18.4	YSD 185	18.5	YSD 186	18.6	YSD 187	18.7	YSD 188	18.8	YSD 189	18.9	YSD 190	19.0	YSD 191	19.1	YSD 192	19.2	YSD 193	19.3	YSD 194	19.4	YSD 195	19.5	YSD 196	19.6	YSD 197	19.7	YSD 198	19.8	YSD 199	19.9	YSD 200	20.0																																																																																																																																																																																																																																																				
YSD 182	18.2	YSD 183	18.3	YSD 184	18.4	YSD 185	18.5	YSD 186	18.6	YSD 187	18.7	YSD 188	18.8	YSD 189	18.9	YSD 190	19.0	YSD 191	19.1	YSD 192	19.2	YSD 193	19.3	YSD 194	19.4	YSD 195	19.5	YSD 196	19.6	YSD 197	19.7	YSD 198	19.8	YSD 199	19.9	YSD 200	20.0																																																																																																																																																																																																																																																						
YSD 183	18.3	YSD 184	18.4	YSD 185	18.5	YSD 186	18.6	YSD 187	18.7	YSD 188	18.8	YSD 189	18.9	YSD 190	19.0	YSD 191	19.1	YSD 192	19.2	YSD 193	19.3	YSD 194	19.4	YSD 195	19.5	YSD 196	19.6	YSD 197	19.7	YSD 198	19.8	YSD 199	19.9	YSD 200	20.0																																																																																																																																																																																																																																																								
YSD 184	18.4	YSD 185	18.5	YSD 186	18.6	YSD 187	18.7	YSD 188	18.8	YSD 189	18.9	YSD 190	19.0	YSD 191	19.1	YSD 192	19.2	YSD 193	19.3	YSD 194	19.4	YSD 195	19.5	YSD 196	19.6	YSD 197	19.7	YSD 198	19.8	YSD 199	19.9	YSD 200	20.0																																																																																																																																																																																																																																																										
YSD 185	18.5	YSD 186	18.6	YSD 187	18.7	YSD 188	18.8	YSD 189	18.9	YSD 190	19.0	YSD 191	19.1	YSD 192	19.2	YSD 193	19.3	YSD 194	19.4	YSD 195	19.5	YSD 196	19.6	YSD 197	19.7	YSD 198	19.8	YSD 199	19.9	YSD 200	20.0																																																																																																																																																																																																																																																												
YSD 186	18.6	YSD 187	18.7	YSD 188	18.8	YSD 189	18.9	YSD 190	19.0	YSD 191	19.1	YSD 192	19.2	YSD 193	19.3	YSD 194	19.4	YSD 195	19.5	YSD 196	19.6	YSD 197	19.7	YSD 198	19.8	YSD 199	19.9	YSD 200	20.0																																																																																																																																																																																																																																																														
YSD 187	18.7	YSD 188	18.8	YSD 189	18.9	YSD 190	19.0	YSD 191	19.1	YSD 192	19.2	YSD 193	19.3	YSD 194	19.4	YSD 195	19.5	YSD 196	19.6	YSD 197	19.7	YSD 198	19.8	YSD 199	19.9	YSD 200	20.0																																																																																																																																																																																																																																																																
YSD 188	18.8	YSD 189	18.9	YSD 190	19.0	YSD 191	19.1	YSD 192	19.2	YSD 193	19.3	YSD 194	19.4	YSD 195	19.5	YSD 196	19.6	YSD 197	19.7	YSD 198	19.8	YSD 199	19.9	YSD 200	20.0																																																																																																																																																																																																																																																																		
YSD 189	18.9	YSD 190	19.0	YSD 191	19.1	YSD 192	19.2	YSD 193	19.3	YSD 194	19.4	YSD 195	19.5	YSD 196	19.6	YSD 197	19.7	YSD 198	19.8	YSD 199	19.9	YSD 200	20.0																																																																																																																																																																																																																																																																				
YSD 190	19.0	YSD 191	19.1	YSD 192	19.2	YSD 193	19.3	YSD 194	19.4	YSD 195	19.5	YSD 196	19.6	YSD 197	19.7	YSD 198	19.8	YSD 199	19.9	YSD 200	20.0																																																																																																																																																																																																																																																																						
YSD 191	19.1	YSD 192	19.2	YSD 193	19.3	YSD 194	19.4	YSD 195	19.5	YSD 196	19.6	YSD 197	19.7	YSD 198	19.8	YSD 199	19.9	YSD 200	20.0																																																																																																																																																																																																																																																																								
YSD 192	19.2	YSD 193	19.3	YSD 194	19.4	YSD 195	19.5	YSD 196	19.6	YSD 197	19.7	YSD 198	19.8	YSD 199	19.9	YSD 200	20.0																																																																																																																																																																																																																																																																										
YSD 193	19.3	YSD 194	19.4	YSD 195	19.5	YSD 196	19.6	YSD 197	19.7	YSD 198	19.8	YSD 199	19.9	YSD 200	20.0																																																																																																																																																																																																																																																																												
YSD 194	19.4	YSD 195	19.5	YSD 196	19.6	YSD 197	19.7	YSD 198	19.8	YSD 199	19.9	YSD 200	20.0																																																																																																																																																																																																																																																																														
YSD 195	19.5	YSD 196	19.6	YSD 197	19.7	YSD 198	19.8	YSD 199	19.9	YSD 200	20.0																																																																																																																																																																																																																																																																																
YSD 196	19.6	YSD 197	19.7	YSD 198	19.8	YSD 199	19.9	YSD 200	20.0																																																																																																																																																																																																																																																																																		
YSD 197	19.7	YSD 198	19.8	YSD 199	19.9	YSD 200	20.0																																																																																																																																																																																																																																																																																				
YSD 198	19.8	YSD 199	19.9	YSD 200	20.0																																																																																																																																																																																																																																																																																						
YSD 199	19.9	YSD 200	20.0																																																																																																																																																																																																																																																																																								
YSD 200	20.0																																																																																																																																																																																																																																																																																										

# Solid Carbide Drill, Inch



YSD TiN



YSD TiAlN

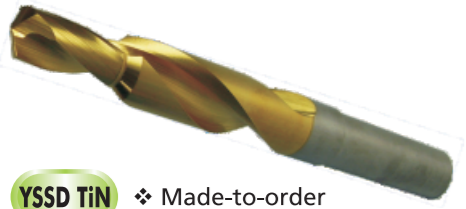

YSSD TiN ❖ Made-to-order

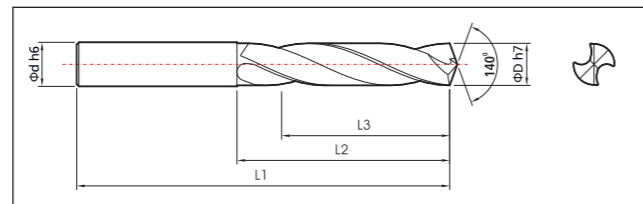

## Model : YSD

- ▶ Solid Carbide drill, Yes standard length, Plain cylindrical HA shank.
- ▶ Effective cutting depth 3xDia. Whistle notch HE shank available on request)
- ▶ 140° self-centering point for accurate hole positioning. regular helix angle : 28° ~ 30°.
- ▶ Manufactured with heavy duty construction and excellent chip evacuation.
- ▶ High performance carbide drill and re-sharpening & re-conditioning available

## Carbide substrate

- ▶ Ultra-fine Micro Grain, PVD TiN, TiAlN coated as standard stock.

## Application

- ▶ To eliminate the need for center drilling and partially reaming. Highest hole quality and tolerance.
- ▶ Specially designed for machining center or CNC application.
- ▶ Broad range application from general to tough material.

## Inch Size

Code No.	D	d	L1	L2	L3
YSD .1250	1/8	3/16	2.16	0.78	0.59
YSD .1562	5/32		2.44	1.25	1
YSD .1875	3/16				
YSD .2188	7/32	1/4	2.91	1.65	1.25
YSD .2500	1/4				
YSD .2656	17/64	5/16	3.11	1.81	1.33
YSD .2812	9/32				
YSD .2969	19/64				
YSD .3125	5/16				
YSD .3281	21/64	3/8	3.5	2.08	1.5
YSD .3438	11/32				
YSD .3594	23/64				
YSD .3750	3/8				

## Inch Size

Code No.	D	d	L1	L2	L3
YSD .3906	25/64	7/16	3.74	2.16	1.57
YSD .4062	13/32				
YSD .4219	27/64				
YSD .4375	7/16				
YSD .4531	29/64	1/2	4.01	2.44	1.65
YSD .4688	15/32				
YSD .4844	31/64				
YSD .5000	1/2				
YSD .5625	9/16	9/16	4.37	2.63	1.77
YSD .6250	5/8	5/8	4.52	2.71	
YSD .6875	11/16	11/16	4.84	2.91	1.85
YSD .7500	3/4	3/4	5	2.99	1.88

# Solid Carbide Drill, Long Series, Metric



YSDL TiN



YSDL TiAlN



YSSD TiN ❖ Made-to-order

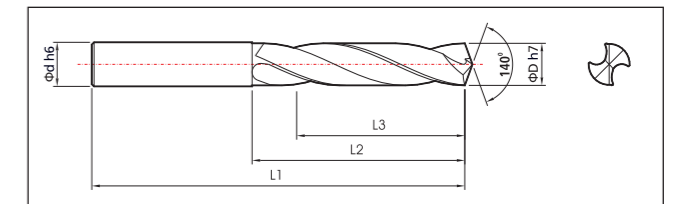

## Model : YSDL

- ▶ Solid Carbide drill, Yes standard length, Plain cylindrical HA shank.
- ▶ Effective cutting depth 5xDia. Whistle notch HE shank available on request)
- ▶ 140° self-centering point for accurate hole positioning. regular helix angle : 28° ~ 30°.
- ▶ Manufactured with heavy duty construction and excellent chip evacuation.
- ▶ High performance carbide drill and re-sharpening & re-conditioning available

## Carbide substrate

- ▶ Ultra-fine Micro Grain, PVD TiN, TiAlN coated as standard stock.

## Application

- ▶ To eliminate the need for center drilling and partially reaming. Highest hole quality and tolerance.
- ▶ Specially designed for machining center or CNC application.
- ▶ Broad range application from general to tough material.

Code No.	D	d	L1	L2	L3
YSDL 030	3.0	4.0	80	45	40
YSDL 031	3.1				
YSDL 032	3.2				
YSDL 033	3.3				
YSDL 034	3.4				
YSDL 035	3.5				
YSDL 036	3.6				39
YSDL 037	3.7				
YSDL 038	3.8				
YSDL 039	3.9				
YSDL 040	4.0				
YSDL 041	4.1				

Code No.	D	d	L1	L2	L3
YSDL 042	4.2	5.0	80	45	38
YSDL 043	4.3				
YSDL 044	4.4				
YSDL 045	4.5				
YSDL 046	4.6				
YSDL 047	4.7				
YSDL 048	4.8				
YSDL 049	4.9				
YSDL 050	5.0				
YSDL 051	5.1				

Code No.	D	d	L1	L2	L3
YSDL 052	5.2	6.0	83	50	41
YSDL 053	5.3				
YSDL 054	5.4				
YSDL 055	5.5				
YSDL 056	5.6				
YSDL 057	5.7				
YSDL 058	5.8				
YSDL 059	5.9				
YSDL 060	6.0				
YSDL 061	6.1				



# Solid Carbide Drill, Long Series, **Metric**

Code No.	D	d	L1	L2	L3	Code No.	D	d	L1	L2	L3	Code No.	D	d	L1	L2	L3
YSDL 062	6.2	7.0	85	53	43	YSDL 108	10.8	11.0	110	73	57	YSDL 154	15.4	16.0			88
YSDL 063	6.3					YSDL 109	10.9					YSDL 155	15.5				
YSDL 064	6.4					YSDL 110	11.0					YSDL 156	15.6				
YSDL 065	6.5					YSDL 111	11.1					YSDL 157	15.7				
YSDL 066	6.6					YSDL 112	11.2					YSDL 158	15.8				
YSDL 067	6.7					YSDL 113	11.3	YSDL 159	15.9								
YSDL 068	6.8					YSDL 114	11.4	YSDL 160	16.0								
YSDL 069	6.9					YSDL 115	11.5	YSDL 161	16.1								
YSDL 070	7.0					YSDL 116	11.6	YSDL 162	16.2								
YSDL 071	7.1					YSDL 117	11.7	YSDL 163	16.3								
YSDL 072	7.2	8.0	90	58	46	YSDL 118	11.8	12.0	120	80	62	YSDL 164	16.4	17.0			87
YSDL 073	7.3					YSDL 119	11.9					YSDL 165	16.5				
YSDL 074	7.4					YSDL 120	12.0					YSDL 166	16.6				
YSDL 075	7.5					YSDL 121	12.1					YSDL 167	16.7				
YSDL 076	7.6					YSDL 122	12.2					YSDL 168	16.8				
YSDL 077	7.7					YSDL 123	12.3	YSDL 169	16.9								
YSDL 078	7.8					YSDL 124	12.4	YSDL 170	17.0								
YSDL 079	7.9					YSDL 125	12.5	YSDL 171	17.1								
YSDL 080	8.0					YSDL 126	12.6	YSDL 172	17.2								
YSDL 081	8.1					YSDL 127	12.7	YSDL 173	17.3								
YSDL 082	8.2	9.0	98	64	51	YSDL 128	12.8	13.0	137	90	71	YSDL 174	17.4	18.0	160	112	85
YSDL 083	8.3					YSDL 129	12.9					YSDL 175	17.5				
YSDL 084	8.4					YSDL 130	13.0					YSDL 176	17.6				
YSDL 085	8.5					YSDL 131	13.1					YSDL 177	17.7				
YSDL 086	8.6					YSDL 132	13.2					YSDL 178	17.8				
YSDL 087	8.7					YSDL 133	13.3	YSDL 179	17.9								
YSDL 088	8.8					YSDL 134	13.4	YSDL 180	18.0								
YSDL 089	8.9					YSDL 135	13.5	YSDL 181	18.1								
YSDL 090	9.0					YSDL 136	13.6	YSDL 182	18.2								
YSDL 091	9.1					YSDL 137	13.7	YSDL 183	18.3								
YSDL 092	9.2	10.0	105	68	53	YSDL 138	13.8	14.0	147	96	75	YSDL 184	18.4	19.0			84
YSDL 093	9.3					YSDL 139	13.9					YSDL 185	18.5				
YSDL 094	9.4					YSDL 140	14.0					YSDL 186	18.6				
YSDL 095	9.5					YSDL 141	14.1					YSDL 187	18.7				
YSDL 096	9.6					YSDL 142	14.2					YSDL 188	18.8				
YSDL 097	9.7					YSDL 143	14.3	YSDL 189	18.9								
YSDL 098	9.8					YSDL 144	14.4	YSDL 190	19.0								
YSDL 099	9.9					YSDL 145	14.5	YSDL 191	19.1								
YSDL 100	10.0					YSDL 146	14.6	YSDL 192	19.2								
YSDL 101	10.1					YSDL 147	14.7	YSDL 193	19.3								
YSDL 102	10.2	11.0	110	73	57	YSDL 148	14.8	15.0	153	100	78	YSDL 194	19.4	20.0			82
YSDL 103	10.3					YSDL 149	14.9					YSDL 195	19.5				
YSDL 104	10.4					YSDL 150	15.0					YSDL 196	19.6				
YSDL 105	10.5					YSDL 151	15.1					YSDL 197	19.7				
YSDL 106	10.6					YSDL 152	15.2					YSDL 198	19.8				
YSDL 107	10.7					YSDL 153	15.3	YSDL 199	19.9								
						YSDL 154	15.4	YSDL 200	20.0								

# Solid Carbide Drill, Long Series, **Inch**

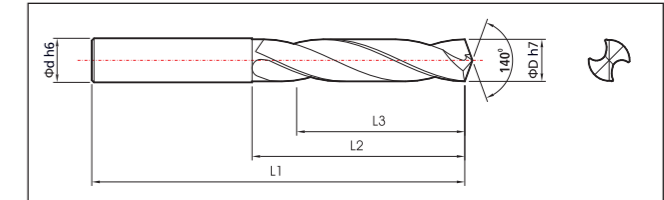

### Model : YSDL

- ▶ Solid Carbide drill, Yes standard length, Plain cylindrical HA shank.
- ▶ Effective cutting depth 5xDia. Whistle notch HE shank available on request
- ▶ 140° self-centering point for accurate hole positioning. regular helix angle : 28° ~ 30°.
- ▶ Manufactured with heavy duty construction and excellent chip evacuation.
- ▶ High performance carbide drill and re-sharpening & re-conditioning available

### Carbide substrate

- ▶ Ultra-fine Micro Grain, PVD TiN, TiAlN coated as standard stock.

### Application

- ▶ To eliminate the need for center drilling and partially reaming. Highest hole quality and tolerance.
- ▶ Specially designed for machining center or CNC application.
- ▶ Broad range application from general to tough material.

### Inch Size

Code No.	D	d	L1	L2	L3
YSDL .1250	1/8	3/16	3.15	1.77	1.57
YSDL .1562	5/32				
YSDL .1875	3/16				
YSDL .2188	7/32	1/4	3.26	2.08	1.69
YSDL .2500	1/4				
YSDL .2656	17/64	5/16	3.54	2.28	1.81
YSDL .2812	9/32				
YSDL .2969	19/64				
YSDL .3125	5/16				
YSDL .3281	21/64				
YSDL .3438	11/32				
YSDL .3594	23/64	3/8	4.13	2.67	2.08
YSDL .3750	3/8				

### Inch Size

Code No.	D	d	L1	L2	L3
YSDL .3906	25/64	7/16	4.33	2.87	2.24
YSDL .4062	13/32				
YSDL .4219	27/64				
YSDL .4375	7/16	1/2	5.39	3.54	2.79
YSDL .4531	29/64				
YSDL .4688	15/32				
YSDL .4844	31/64	11/16	6.29	4.4	3.46
YSDL .5000	1/2				
YSDL .5625	9/16				
YSDL .6250	5/8				
YSDL .6875	11/16	3/4	3/4		
YSDL .7500	3/4				

# Solid Carbide Coolant Drill, Metric

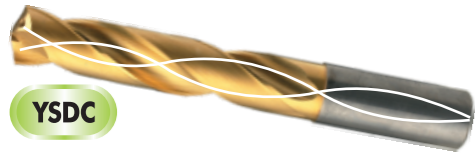

YSDC

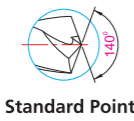

Standard Point

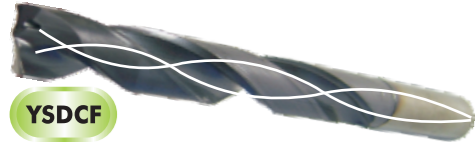

YSDCF

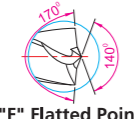

"F" Flatted Point



YSDCP

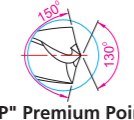

"P" Premium Point

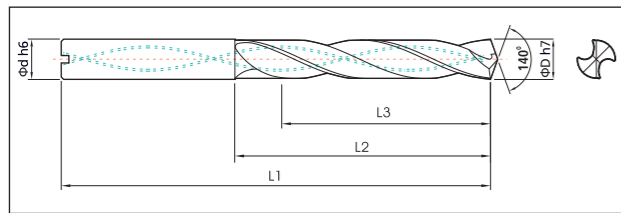

## Model : YSDC

- ▶ Solid Carbide Coolant hole drill, HA shank
- ▶ 140° self-centering point for accurate hole positioning. regular helix angle : 28° ~ 30°.
- ▶ Manufactured with heavy duty construction and excellent chip evacuation.

## Carbide substrate:

- ▶ Micro Grain Carbide, TiN & TiAlN

## Application

- ▶ High productivity. Coolant fed design efficiently cools the workpiece and provides good chip removal.
- ▶ To eliminate the need for center drilling and partially reaming. Highest hole quality and tolerance.
- ▶ Specially designed for machining center or CNC application.

Code No.	D	d	L1	L2	L3
YSDC 050	5.0	5.0	72	42	35
YSDC 051	5.1				
YSDC 052	5.2				
YSDC 053	5.3				
YSDC 054	5.4				
YSDC 055	5.5	33			
YSDC 056	5.6				
YSDC 057	5.7				
YSDC 058	5.8				
YSDC 059	5.9				
YSDC 060	6.0				

Code No.	D	d	L1	L2	L3
YSDC 061	6.1	6.0	72	42	33
YSDC 062	6.2	7.0	97	60	50
YSDC 063	6.3				
YSDC 064	6.4				
YSDC 065	6.5				
YSDC 066	6.6				
YSDC 067	6.7				
YSDC 068	6.8				
YSDC 069	6.9				
YSDC 070	7.0				
YSDC 071	7.1				

Code No.	D	d	L1	L2	L3
YSDC 072	7.2	8.0	97	60	48
YSDC 073	7.3				
YSDC 074	7.4				
YSDC 075	7.5				
YSDC 076	7.6				
YSDC 077	7.7				
YSDC 078	7.8				
YSDC 079	7.9				
YSDC 080	8.0				
YSDC 081	8.1				

Code No.	D	d	L1	L2	L3
YSDC 082	8.2	9.0	97	60	47
YSDC 083	8.3				
YSDC 084	8.4				
YSDC 085	8.5				
YSDC 086	8.6				
YSDC 087	8.7				
YSDC 088	8.8				
YSDC 089	8.9				
YSDC 090	9.0				
YSDC 091	9.1				
YSDC 092	9.2	10.0			
YSDC 093	9.3				
YSDC 094	9.4				
YSDC 095	9.5				
YSDC 096	9.6				
YSDC 097	9.7				
YSDC 098	9.8				
YSDC 099	9.9				
YSDC 100	10.0				
YSDC 101	10.1				
YSDC 102	10.2	11.0			
YSDC 103	10.3				
YSDC 104	10.4				
YSDC 105	10.5				
YSDC 106	10.6				
YSDC 107	10.7				
YSDC 108	10.8				
YSDC 109	10.9				
YSDC 110	11.0				
YSDC 111	11.1				
YSDC 112	11.2	12.0	140	100	
YSDC 113	11.3				
YSDC 114	11.4				
YSDC 115	11.5				
YSDC 116	11.6				
YSDC 117	11.7				
YSDC 118	11.8				
YSDC 119	11.9				
YSDC 120	12.0				
YSDC 121	12.1				

Code No.	D	d	L1	L2	L3
YSDC 122	12.2	13.0			83
YSDC 123	12.3				
YSDC 124	12.4				
YSDC 125	12.5				
YSDC 126	12.6				
YSDC 127	12.7				
YSDC 128	12.8				
YSDC 129	12.9				
YSDC 130	13.0				
YSDC 131	13.1				
YSDC 132	13.2	14.0			81
YSDC 133	13.3				
YSDC 134	13.4				
YSDC 135	13.5				
YSDC 136	13.6				
YSDC 137	13.7				
YSDC 138	13.8				
YSDC 139	13.9				
YSDC 140	14.0				
YSDC 141	14.1				
YSDC 142	14.2	15.0	143	102	
YSDC 143	14.3				
YSDC 144	14.4				
YSDC 145	14.5				
YSDC 146	14.6				
YSDC 147	14.7				
YSDC 148	14.8				
YSDC 149	14.9				
YSDC 150	15.0				
YSDC 151	15.1				
YSDC 152	15.2	16.0			80
YSDC 153	15.3				
YSDC 154	15.4				
YSDC 155	15.5				
YSDC 156	15.6				
YSDC 157	15.7				
YSDC 158	15.8				
YSDC 159	15.9				
YSDC 160	16.0				
YSDC 161	16.1				

Code No.	D	d	L1	L2	L3
YSDC 162	16.2	17.0			79
YSDC 163	16.3				
YSDC 164	16.4				
YSDC 165	16.5				
YSDC 166	16.6				
YSDC 167	16.7				
YSDC 168	16.8				
YSDC 169	16.9				
YSDC 170	17.0				
YSDC 171	17.1				
YSDC 172	17.2	18.0			77
YSDC 173	17.3				
YSDC 174	17.4				
YSDC 175	17.5				
YSDC 176	17.6				
YSDC 177	17.7				
YSDC 178	17.8				
YSDC 179	17.9				
YSDC 180	18.0				
YSDC 181	18.1				
YSDC 182	18.2	19.0	146	104	
YSDC 183	18.3				
YSDC 184	18.4				
YSDC 185	18.5				
YSDC 186	18.6				
YSDC 187	18.7				
YSDC 188	18.8				
YSDC 189	18.9				
YSDC 190	19.0				
YSDC 191	19.1				
YSDC 192	19.2	20.0			76
YSDC 193	19.3				
YSDC 194	19.4				
YSDC 195	19.5				
YSDC 196	19.6				
YSDC 197	19.7				
YSDC 198	19.8				
YSDC 199	19.9				
YSDC 200	20.0				

❖ Available small dia. below 5.0 and special step coolant drill on request.

❖ YSDCP & YSDCF available upon request only



# Solid Carbide Coolant Drill, Inch

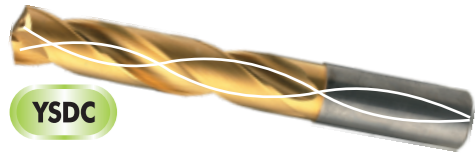

YSDC

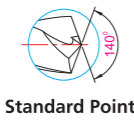

Standard Point

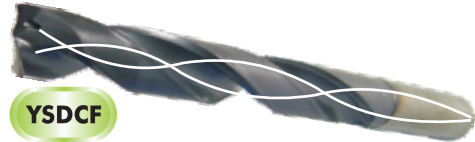

YSDCF

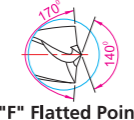

"F" Flatted Point



YSDCP



"P" Premium Point

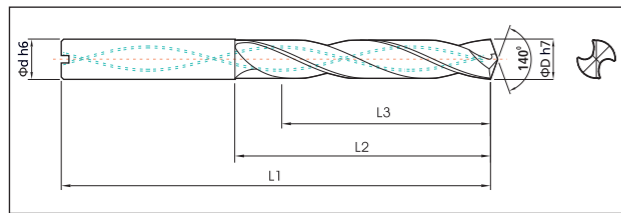

## Model : YSDC

- ▶ Solid Carbide Coolant hole drill, HA shank
- ▶ 140° self-centering point for accurate hole positioning. regular helix angle : 28° ~ 30°.
- ▶ Manufactured with heavy duty construction and excellent chip evacuation.

## Carbide substrate:

- ▶ Micro Grain Carbide, TiN & TiAlN

## Application

- ▶ High productivity. Coolant fed design efficiently cools the workpiece and provides good chip removal.
- ▶ To eliminate the need for center drilling and partially reaming. Highest hole quality and tolerance.
- ▶ Specially designed for machining center or CNC application.

## Inch Size

## Inch Size

Code No.	D	d	L1	L2	L3
YSDC .1875	3/16	3/16	3.22		1.54
YSDC .2188	7/32	1/4	3.23	1.73	1.34
YSDC .2500	1/4				
YSDC .2656	17/64	5/16	3.58	2.08	1.61
YSDC .2812	9/32				
YSDC .2969	19/64				
YSDC .3125	5/16				
YSDC .3281	21/64				
YSDC .3438	11/32	3/8	4.05	2.4	1.81
YSDC .3594	23/64				
YSDC .3750	3/8				

Code No.	D	d	L1	L2	L3
YSDC .3906	25/64	7/16	4.37	2.63	2
YSDC .4062	13/32				
YSDC .4219	27/64				
YSDC .4375	7/16	1/2	4.64	2.79	2.05
YSDC .4531	29/64				
YSDC .4688	15/32				
YSDC .4844	31/64				
YSDC .5000	1/2	9/16	4.88	3.03	2.17
YSDC .5625	9/16				
YSDC .6250	5/8				
YSDC .6875	11/16				
YSDC .7500	3/4				

# Solid Carbide Coolant Drill, Reinforced Shank

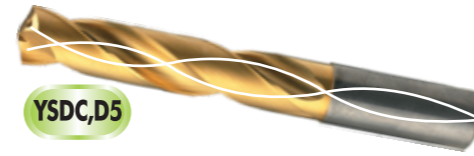

YSDC,D5

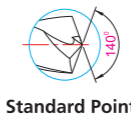

Standard Point

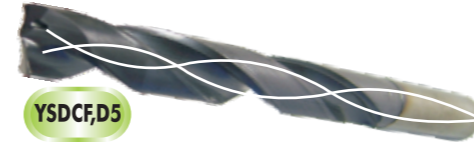

YSDCF,D5

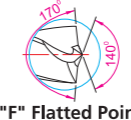

"F" Flatted Point



YSDCP,D5

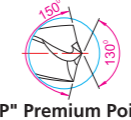

"P" Premium Point

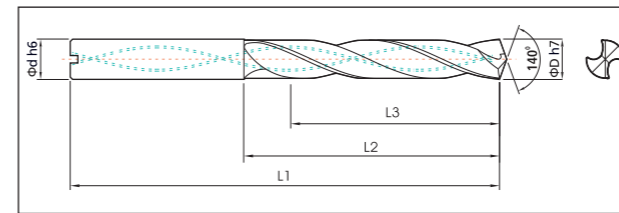

## Model : YSDC, D5

- ▶ Solid Carbide Coolant hole drill, Whistle notch DIN6535 HE shank, effective cutting depth 5xDia.
- ▶ Cylindrical HA shank is available on request.
- ▶ 140° self-centering point for accurate hole positioning. regular helix angle : 28° ~ 30°.
- ▶ Manufactured with heavy duty construction and excellent chip evacuation.

## Carbide substrate:

- ▶ Micro Grain Carbide, TiN & TiAlN

## Application

- ▶ High productivity. Coolant fed design efficiently cools the workpiece and provides good chip removal.
- ▶ To eliminate the need for center drilling and partially reaming. Highest hole quality and tolerance.
- ▶ Specially designed for machining center or CNC application.

Code No.	D	d	L1	L2	L3
YSDC 050D5	5.0	6.0	82	44	35
YSDC 051D5	5.1				
YSDC 052D5	5.2				
YSDC 053D5	5.3				
YSDC 054D5	5.4				
YSDC 055D5	5.5				
YSDC 056D5	5.6				
YSDC 057D5	5.7				
YSDC 058D5	5.8				
YSDC 059D5	5.9				
YSDC 060D5	6.0	8.0	91	53	43
YSDC 061D5	6.1				
YSDC 062D5	6.2				
YSDC 063D5	6.3				
YSDC 064D5	6.4				
YSDC 065D5	6.5				

Code No.	D	d	L1	L2	L3
YSDC 066D5	6.6	8.0	91	53	41
YSDC 067D5	6.7				
YSDC 068D5	6.8				
YSDC 069D5	6.9				
YSDC 070D5	7.0				
YSDC 071D5	7.1				
YSDC 072D5	7.2				
YSDC 073D5	7.3				
YSDC 074D5	7.4				
YSDC 075D5	7.5				
YSDC 076D5	7.6	10.0	103	61	48
YSDC 077D5	7.7				
YSDC 078D5	7.8				
YSDC 079D5	7.9				
YSDC 080D5	8.0				
YSDC 081D5	8.1				

Code No.	D	d	L1	L2	L3
YSDC 082D5	8.2	10.0	103	61	46
YSDC 083D5	8.3				
YSDC 084D5	8.4				
YSDC 085D5	8.5				
YSDC 086D5	8.6				
YSDC 087D5	8.7				
YSDC 088D5	8.8				
YSDC 089D5	8.9				
YSDC 090D5	9.0				
YSDC 091D5	9.1				
YSDC 092D5	9.2	10.0	103	61	48
YSDC 093D5	9.3				
YSDC 094D5	9.4				
YSDC 095D5	9.5				
YSDC 096D5	9.6				
YSDC 097D5	9.7				

# Solid Carbide Coolant Drill, Reinforced Shank

Code No.	D	d	L1	L2	L3	Code No.	D	d	L1	L2	L3	Code No.	D	d	L1	L2	L3
YSDC 098D5	9.8	10.0	103	61	46	YSDC 132D5	13.2	14.0	124	77	56	YSDC 166D5	16.6	18.0	143	93	68
YSDC 099D5	9.9					YSDC 133D5	13.3					YSDC 167D5	16.7				
YSDC 100D5	10.0					YSDC 134D5	13.4					YSDC 168D5	16.8				
YSDC 101D5	10.1	12.0	118	71	55	YSDC 135D5	13.5	16.0	133	83	53	YSDC 169D5	16.9	20.0	153	101	66
YSDC 102D5	10.2					YSDC 136D5	13.6					YSDC 170D5	17.0				
YSDC 103D5	10.3					YSDC 137D5	13.7					YSDC 171D5	17.1				
YSDC 104D5	10.4					YSDC 138D5	13.8					YSDC 172D5	17.2				
YSDC 105D5	10.5					YSDC 139D5	13.9					YSDC 173D5	17.3				
YSDC 106D5	10.6					YSDC 140D5	14.0					YSDC 174D5	17.4				
YSDC 107D5	10.7					YSDC 141D5	14.1					YSDC 175D5	17.5				
YSDC 108D5	10.8					YSDC 142D5	14.2					YSDC 176D5	17.6				
YSDC 109D5	10.9					YSDC 143D5	14.3					YSDC 177D5	17.7				
YSDC 110D5	11.0					YSDC 144D5	14.4					YSDC 178D5	17.8				
YSDC 111D5	11.1	12.0	118	71	53	YSDC 145D5	14.5	16.0	133	83	53	YSDC 179D5	17.9	20.0	153	101	66
YSDC 112D5	11.2					YSDC 146D5	14.6					YSDC 180D5	18.0				
YSDC 113D5	11.3					YSDC 147D5	14.7					YSDC 181D5	18.1				
YSDC 114D5	11.4					YSDC 148D5	14.8					YSDC 182D5	18.2				
YSDC 115D5	11.5					YSDC 149D5	14.9					YSDC 183D5	18.3				
YSDC 116D5	11.6					YSDC 150D5	15.0					YSDC 184D5	18.4				
YSDC 117D5	11.7					YSDC 151D5	15.1					YSDC 185D5	18.5				
YSDC 118D5	11.8					YSDC 152D5	15.2					YSDC 186D5	18.6				
YSDC 119D5	11.9					YSDC 153D5	15.3					YSDC 187D5	18.7				
YSDC 120D5	12.0					YSDC 154D5	15.4					YSDC 188D5	18.8				
YSDC 121D5	12.1	14.0	124	77	58	YSDC 155D5	15.5	18.0	143	93	68	YSDC 189D5	18.9	20.0	153	101	63
YSDC 122D5	12.2					YSDC 156D5	15.6					YSDC 190D5	19.0				
YSDC 123D5	12.3					YSDC 157D5	15.7					YSDC 191D5	19.1				
YSDC 124D5	12.4					YSDC 158D5	15.8					YSDC 192D5	19.2				
YSDC 125D5	12.5					YSDC 159D5	15.9					YSDC 193D5	19.3				
YSDC 126D5	12.6					YSDC 160D5	16.0					YSDC 194D5	19.4				
YSDC 127D5	12.7					YSDC 161D5	16.1					YSDC 195D5	19.5				
YSDC 128D5	12.8					YSDC 162D5	16.2					YSDC 196D5	19.6				
YSDC 129D5	12.9					YSDC 163D5	16.3					YSDC 197D5	19.7				
YSDC 130D5	13.0					YSDC 164D5	16.4					YSDC 198D5	19.8				
YSDC 131D5	13.1	YSDC 165D5	16.5	YSDC 199D5	19.9												
						YSDC 200D5	20.0										

❖ Available small dia. below 5.0mm & coolant step drill on request.  
❖ YSDC, D5 with plain cylindrical HA shank available on request.

# Solid Carbide Coolant Drill, Long series (8xD)

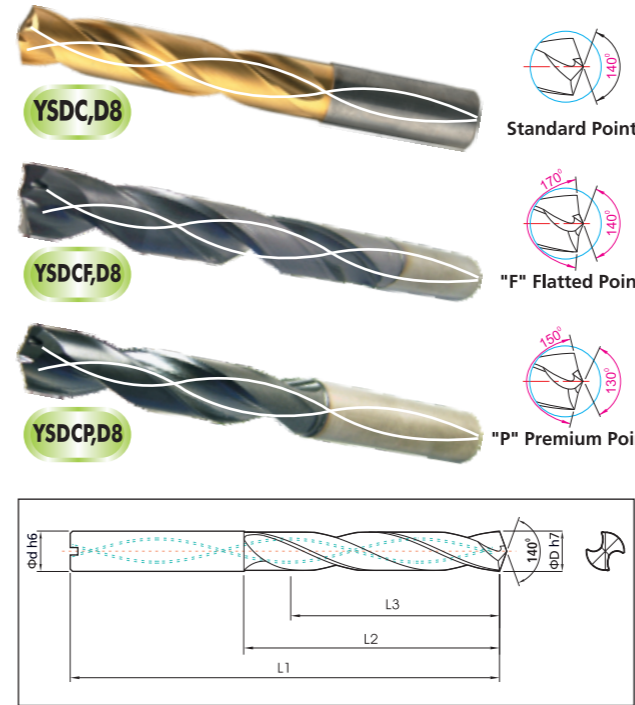

### Model : YSDC, D8

- ▶ Solid Carbide Coolant hole drill, Whistle notch DIN6535 HE shank, effective cutting depth 8xDia.
- ▶ Cylindrical HA shank is available on request.
- ▶ 140° self-centering point for accurate hole positioning. regular helix angle : 28° ~ 30°.
- ▶ Manufactured with heavy duty construction and excellent chip evacuation.

### Carbide substrate:

- ▶ Micro Grain Carbide , TiN & TiAlN

### Application

- ▶ High productivity. Coolant fed design efficiently cools the workpiece and provides good chip removal.
- ▶ To eliminate the need for center drilling and partially reaming. Highest hole quality and tolerance.
- ▶ Specially designed for machining center or CNC application.

Code No.	D	d	L1	L2	L3	Code No.	D	d	L1	L2	L3	Code No.	D	d	L1	L2	L3
YSDC 050D8	5.0	6.0	95	57	48	YSDC 066D8	6.6	8.0	114	76	66	YSDC 082D8	8.2	10.0	137	95	82
YSDC 051D8	5.1					YSDC 067D8	6.7					YSDC 083D8	8.3				
YSDC 052D8	5.2					YSDC 068D8	6.8					YSDC 084D8	8.4				
YSDC 053D8	5.3	8.0	114	76	64	YSDC 069D8	6.9	20.0	153	101	63	YSDC 085D8	8.5	24.0	171	109	70
YSDC 054D8	5.4					YSDC 070D8	7.0					YSDC 086D8	8.6				
YSDC 055D8	5.5					YSDC 071D8	7.1					YSDC 087D8	8.7				
YSDC 056D8	5.6					YSDC 072D8	7.2					YSDC 088D8	8.8				
YSDC 057D8	5.7					YSDC 073D8	7.3					YSDC 089D8	8.9				
YSDC 058D8	5.8					YSDC 074D8	7.4					YSDC 090D8	9.0				
YSDC 059D8	5.9					YSDC 075D8	7.5					YSDC 091D8	9.1				
YSDC 060D8	6.0					YSDC 076D8	7.6					YSDC 092D8	9.2				
YSDC 061D8	6.1					YSDC 077D8	7.7					YSDC 093D8	9.3				
YSDC 062D8	6.2					YSDC 078D8	7.8					YSDC 094D8	9.4				
YSDC 063D8	6.3	8.0	114	76	66	YSDC 079D8	7.9	24.0	171	109	70	YSDC 095D8	9.5	28.0	189	117	78
YSDC 064D8	6.4					YSDC 080D8	8.0					YSDC 096D8	9.6				
YSDC 065D8	6.5					YSDC 081D8	8.1					YSDC 097D8	9.7				

Continued ▶▶



# Solid Carbide Coolant Drill, Long series (8xD)

Code No.	D	d	L1	L2	L3	Code No.	D	d	L1	L2	L3	Code No.	D	d	L1	L2	L3													
YSDC 098D8	9.8	10.0	137	95	80	YSDC 132D8	13.2	14.0	180	133	112	YSDC 166D8	16.6	18.0	221	171	146													
YSDC 099D8	9.9					YSDC 133D8	13.3					YSDC 167D8	16.7																	
YSDC 100D8	10.0					YSDC 134D8	13.4					YSDC 168D8	16.8																	
YSDC 101D8	10.1	YSDC 135D8	13.5	YSDC 169D8	16.9																									
YSDC 102D8	10.2	YSDC 136D8	13.6	YSDC 170D8	17.0																									
YSDC 103D8	10.3	YSDC 137D8	13.7	YSDC 171D8	17.1																									
YSDC 104D8	10.4	12.0	161	114	98	YSDC 138D8	13.8	16.0	202	152	124	YSDC 172D8	17.2					20.0	242	190	144									
YSDC 105D8	10.5					YSDC 139D8	13.9					YSDC 173D8	17.3																	
YSDC 106D8	10.6					YSDC 140D8	14.0					YSDC 174D8	17.4																	
YSDC 107D8	10.7					YSDC 141D8	14.1					YSDC 175D8	17.5																	
YSDC 108D8	10.8					YSDC 142D8	14.2					YSDC 176D8	17.6																	
YSDC 109D8	10.9					YSDC 143D8	14.3					YSDC 177D8	17.7																	
YSDC 110D8	11.0					96	114	96	YSDC 144D8	14.4	16.0	202	152	124	YSDC 178D8	17.8	7.0					74	37	30	11	25	YCH 070			
YSDC 111D8	11.1								YSDC 145D8	14.5					YSDC 179D8	17.9														
YSDC 112D8	11.2								YSDC 146D8	14.6					YSDC 180D8	18.0														
YSDC 113D8	11.3								YSDC 147D8	14.7					YSDC 181D8	18.1														
YSDC 114D8	11.4								YSDC 148D8	14.8					YSDC 182D8	18.2														
YSDC 115D8	11.5								YSDC 149D8	14.9					YSDC 183D8	18.3														
YSDC 116D8	11.6	14.0	180	133	114				YSDC 150D8	15.0	18.0	221	171	146	YSDC 184D8	18.4		9.0	84	45	36							14	31	YCH 090
YSDC 117D8	11.7								YSDC 151D8	15.1					YSDC 185D8	18.5														
YSDC 118D8	11.8								YSDC 152D8	15.2					YSDC 186D8	18.6														
YSDC 119D8	11.9								YSDC 153D8	15.3					YSDC 187D8	18.7														
YSDC 120D8	12.0								YSDC 154D8	15.4					YSDC 188D8	18.8														
YSDC 121D8	12.1								YSDC 155D8	15.5					YSDC 189D8	18.9														
YSDC 122D8	12.2	14.0	180	133	114	YSDC 156D8	15.6	18.0	221	171	146	YSDC 190D8	19.0	10.0	88	48	42					16	33	YCH 102						
YSDC 123D8	12.3					YSDC 157D8	15.7					YSDC 191D8	19.1																	
YSDC 124D8	12.4					YSDC 158D8	15.8					YSDC 192D8	19.2																	
YSDC 125D8	12.5					YSDC 159D8	15.9					YSDC 193D8	19.3																	
YSDC 126D8	12.6					YSDC 160D8	16.0					YSDC 194D8	19.4																	
YSDC 127D8	12.7					YSDC 161D8	16.1					YSDC 195D8	19.5																	
YSDC 128D8	12.8	14.0	180	133	114	YSDC 162D8	16.2	18.0	221	171	146	YSDC 196D8	19.6					11.0	92	50	44				18	35	YCH 104			
YSDC 129D8	12.9					YSDC 163D8	16.3					YSDC 197D8	19.7																	
YSDC 130D8	13.0					YSDC 164D8	16.4					YSDC 198D8	19.8																	
YSDC 131D8	13.1					YSDC 165D8	16.5					YSDC 199D8	19.9																	
												YSDC 200D8	20.0																	

❖ Available small dia. below 5.0mm & coolant step drill on request.  
❖ Plain cylindrical HA shank available on request.

# Solid Carbide Chamfer Drill, Metric



YCD

(The above picture illustrate YCD + YCH complete kit.)

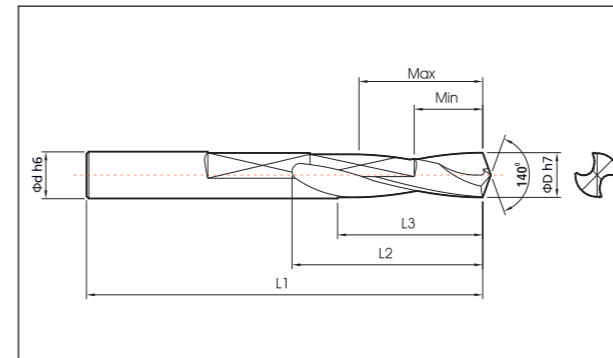

### Model : YCD

- ▶ Solid Carbide Chamfer drill, Plain cylindrical shank with flat grinding to fit YCH holder.
- ▶ 140° self-centering point for accurate hole positioning. Slow helix angle : 15° spiral(to adjust cutting depth).
- ▶ YCD is used with combination YCH chamfer holder and carbide insert XCGX1102.
- ▶ Holder can be moved back and forth by one locking screw to adjust cutting depth.

### Carbide substrate:

- ▶ Ultra-fine Micro Grain, TiN(standard stock), TiAlN

### Application

- ▶ Economically drilling and chamfering(or countersinking) in one operation
- ▶ To eliminate the need for center drilling and partially reaming. Specially designed for machining center or CNC application.
- ▶ Broad range application from general to tough material.

Code No.	D	d	L1	L2	L3	Hole depth		Applicable Holder							
						Min	Max								
YCD 051	5.1	6.0	66	30	24	9	20	YCH 060							
YCD 052	5.2														
YCD 053	5.3														
YCD 054	5.4														
YCD 055	5.5														
YCD 056	5.6														
YCD 057	5.7														
YCD 058	5.8														
YCD 059	5.9														
YCD 060	6.0														
YCD 061	6.1								7.0	74	37	30	11	25	YCH 070
YCD 062	6.2														
YCD 063	6.3														
YCD 064	6.4														
YCD 065	6.5														
YCD 066	6.6														
YCD 067	6.7														
YCD 068	6.8														
YCD 069	6.9														
YCD 070	7.0														

Code No.	D	d	L1	L2	L3	Hole depth		Applicable Holder							
						Min	Max								
YCD 071	7.1	8.0	79	41	33	12	28	YCH 080							
YCD 072	7.2														
YCD 073	7.3														
YCD 074	7.4														
YCD 075	7.5														
YCD 076	7.6														
YCD 077	7.7														
YCD 078	7.8														
YCD 079	7.9														
YCD 080	8.0														
YCD 081	8.1								9.0	84	45	36	14	31	YCH 090
YCD 082	8.2														
YCD 083	8.3														
YCD 084	8.4														
YCD 085	8.5														
YCD 086	8.6														
YCD 087	8.7														
YCD 088	8.8														
YCD 089	8.9														
YCD 090	9.0														

# Solid Carbide Chamfer Drill, **Metric**

Code No.	D	d	L1	L2	L3	Hole depth		Applicable Holder
						Min	Max	
YCD 091	9.1	10.0	89	49	39	16	34	YCH 100
YCD 092	9.2							
YCD 093	9.3							
YCD 094	9.4							
YCD 095	9.5							
YCD 096	9.6							
YCD 097	9.7							
YCD 098	9.8							
YCD 099	9.9							
YCD 100	10.0							
YCD 101	10.1	11.0	95	47	36	17	31	YCH 110
YCD 102	10.2							
YCD 103	10.3							
YCD 104	10.4							
YCD 105	10.5							
YCD 106	10.6							
YCD 107	10.7							
YCD 108	10.8							
YCD 109	10.9							
YCD 110	11.0							
YCD 111	11.1	12.0	102	53	41	19	35	YCH 120
YCD 112	11.2							
YCD 113	11.3							
YCD 114	11.4							
YCD 115	11.5							
YCD 116	11.6							
YCD 117	11.7							
YCD 118	11.8							
YCD 119	11.9							
YCD 120	12.0							
YCD 121	12.1	13.0	102	54	41	19	35	YCH 130
YCD 122	12.2							
YCD 123	12.3							
YCD 124	12.4							
YCD 125	12.5							
YCD 126	12.6							
YCD 127	12.7							
YCD 128	12.8							
YCD 129	12.9							
YCD 130	13.0							
YCD 131	13.1	14.0	107	58	44	20	38	YCH 140
YCD 132	13.2							
YCD 133	13.3							
YCD 134	13.4							
YCD 135	13.5							
YCD 136	13.6							
YCD 137	13.7							
YCD 138	13.8							
YCD 139	13.9							
YCD 140	14.0							
YCD 141	14.1	15.0	111	62	47	24	41	YCH 150
YCD 142	14.2							
YCD 143	14.3							
YCD 144	14.4							
YCD 145	14.5							

Code No.	D	d	L1	L2	L3	Hole depth		Applicable Holder
						Min	Max	
YCD 146	14.6	15.0	111	62	47	24	41	YCH 150
YCD 147	14.7							
YCD 148	14.8							
YCD 149	14.9							
YCD 150	15.0							
YCD 151	15.1							
YCD 152	15.2							
YCD 153	15.3							
YCD 154	15.4							
YCD 155	15.5							
YCD 156	15.6	16.0	115	65	49	25	43	YCH 160
YCD 157	15.7							
YCD 158	15.8							
YCD 159	15.9							
YCD 160	16.0							
YCD 161	16.1							
YCD 162	16.2							
YCD 163	16.3							
YCD 164	16.4							
YCD 165	16.5							
YCD 166	16.6	17.0	119	69	52	26	46	YCH 170
YCD 167	16.7							
YCD 168	16.8							
YCD 169	16.9							
YCD 170	17.0							
YCD 171	17.1							
YCD 172	17.2							
YCD 173	17.3							
YCD 174	17.4							
YCD 175	17.5							
YCD 176	17.6	18.0	123	73	55	27	48	YCH 180
YCD 177	17.7							
YCD 178	17.8							
YCD 179	17.9							
YCD 180	18.0							
YCD 181	18.1							
YCD 182	18.2							
YCD 183	18.3							
YCD 184	18.4							
YCD 185	18.5							
YCD 186	18.6	19.0	127	76	57	28	50	YCH 190
YCD 187	18.7							
YCD 188	18.8							
YCD 189	18.9							
YCD 190	19.0							
YCD 191	19.1							
YCD 192	19.2							
YCD 193	19.3							
YCD 194	19.4							
YCD 195	19.5							
YCD 196	19.6	20.0	131	80	60	30	53	YCH 200
YCD 197	19.7							
YCD 198	19.8							
YCD 199	19.9							
YCD 200	20.0							

# Solid Carbide Chamfer Drill, **Inch**

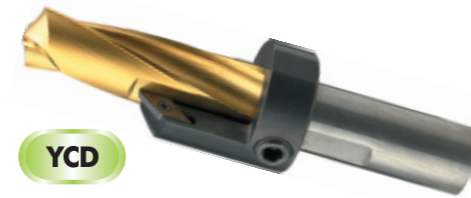

(The above picture illustrate YCD + YCH complete kit.)

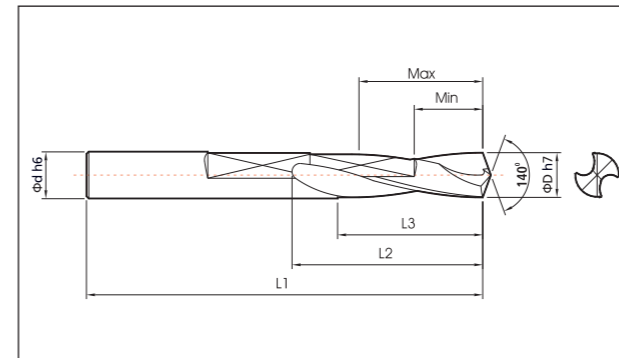

### Model : YCD

- ▶ Solid Carbide Chamfer drill, Plain cylindrical shank with flat grinding to fit YCH holder.
- ▶ 140° self-centering point for accurate hole positioning. Slow helix angle : 15° spiral(to adjust cutting depth).
- ▶ YCD is used with combination YCH chamfer holder and carbide insert XCGX1102.
- ▶ Holder can be moved back and forth by one locking screw to adjust cutting depth.

### Carbide substrate:

- ▶ Ultra-fine Micro Grain, TiN(standard stock), TiAlN

### Application

- ▶ Economically drilling and chamfering(or countersinking) in one operation
- ▶ To eliminate the need for center drilling and partially reaming. Specially designed for machining center or CNC application.
- ▶ Broad range application from general to tough material.

### Inch Size

Code No.	D	d	L1	L2	L3	Hole depth		Applicable Holder
						Min	Max	
YCD .2010	#7	1/4	2.59	1.18	0.94	0.35	0.78	YCH.2500
YCD .2130	#3							
YCD .2570	F							
YCD .2720	I	5/16	3.11	1.61	1.29	1.1	YCH.3125	
YCD .3125	5/16							
YCD .3320	Q	3/8	3.5	1.92	1.53	1.33	YCH.3750	
YCD .3680	U							
YCD .3906	25/64							
YCD .4219	25/64	7/16	3.74	1.85	1.41	0.66	1.22	YCH.4375

### Inch Size

Code No.	D	d	L1	L2	L3	Hole depth		Applicable Holder
						Min	Max	
YCD .4531	29/64	7/16	3.74	1.85	1.41	0.66	1.22	YCH.4375
YCD .4844	31/64	1/2	4.01	2.12	1.61	0.74	1.37	YCH.5000
YCD .5156	33/64							
YCD .5312	17/32	9/16	4.21	2.28	1.73	0.78	1.49	YCH.5625
YCD .5781	37/64							
YCD .6562	21/32	11/16	4.68	2.71	2.04	1.02	1.81	YCH.6875
YCD .6875	11/16							
YCD .7656	49/64	3/4	5.15	3.14	2.36	1.18	2.08	YCH.7500
YCD .8125	13/16							



# Chamfer Holder, Metric

YCH



## Model : YCH

- ▶ Specially designed to work with Solid Chamfer Drill (YCD) & Insert XCGX1102.
- ▶ Drilling and chamfering in one operation economically.
- ▶ Carbide Insert XCGX1102 has two cutting edges for economic use.
- ▶ Holder moveable back and forth to adjust cutting depth by SS bolt.

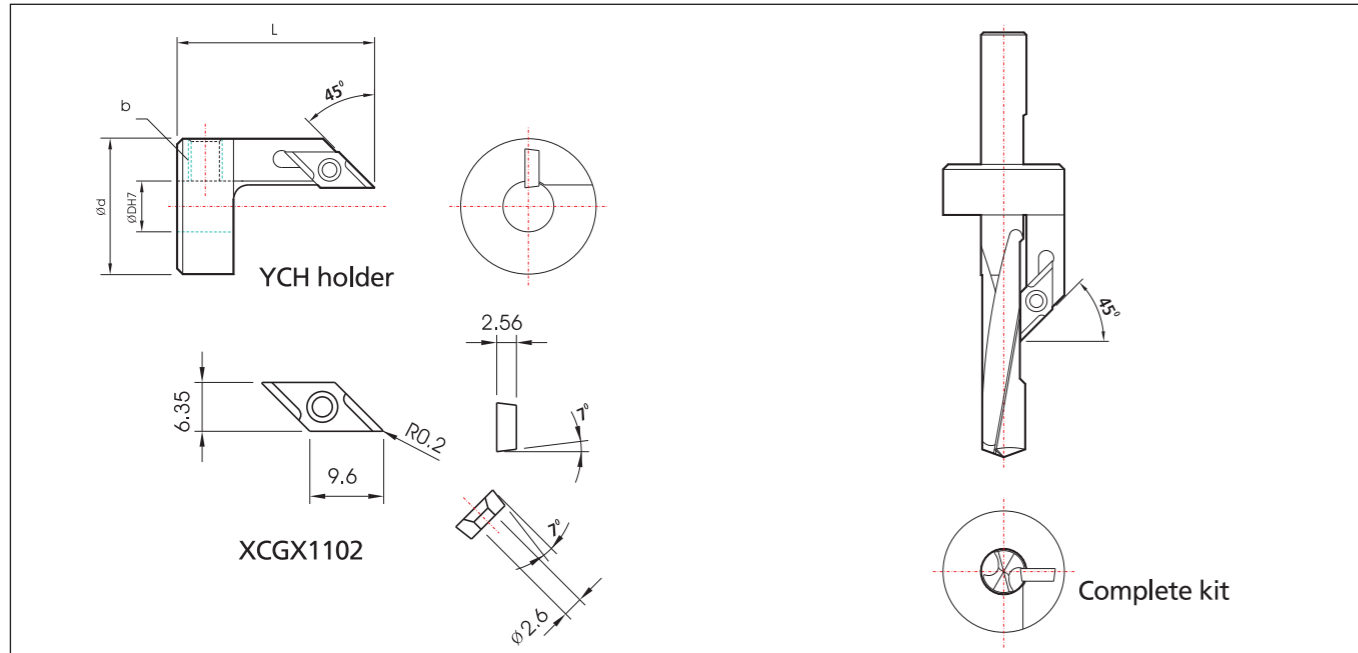

Code No.	D	d	L	Socket Screw Bolt size (b)	Applicable size range(YCD model)
YCH 060	6.0	21	29	M6 x 1.0P	YCD 051~060
YCH 070	7.0	22	32		YCD 061~070
YCH 080	8.0	23	34		YCD 071~080
YCH 090	9.0	24	35		YCD 081~090
YCH 100	10.0	25	36	M8 x 1.25P	YCD 091~100
YCH 110	11.0	26	34		YCD 101~110
YCH 120	12.0	27	36		YCD 111~120
YCH 130	13.0	28	36		YCD 121~130
YCH 140	14.0	29	38	M10 x 1.5P	YCD 131~140
YCH 150	15.0	30	39		YCD 141~150
YCH 160	16.0	31	40		YCD 151~160
YCH 170	17.0	32	42		YCD 161~170
YCH 180	18.0	33	43		YCD 171~180
YCH 190	19.0	34	44		YCD 181~190
YCH 200	20.0	35	45		YCD 191~200

❖ See page 61 of applicable YCD drill together with this model.

# Chamfer Holder, Inch

YCH

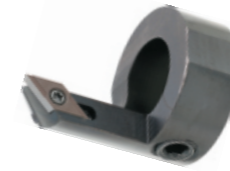

## Model : YCH

- ▶ Specially designed to work with Solid Chamfer Drill (YCD) & Insert XCGX1102.
- ▶ Drilling and chamfering in one operation economically.
- ▶ Carbide Insert XCGX1102 has two cutting edges for economic use.
- ▶ Holder moveable back and forth to adjust cutting depth by SS bolt.

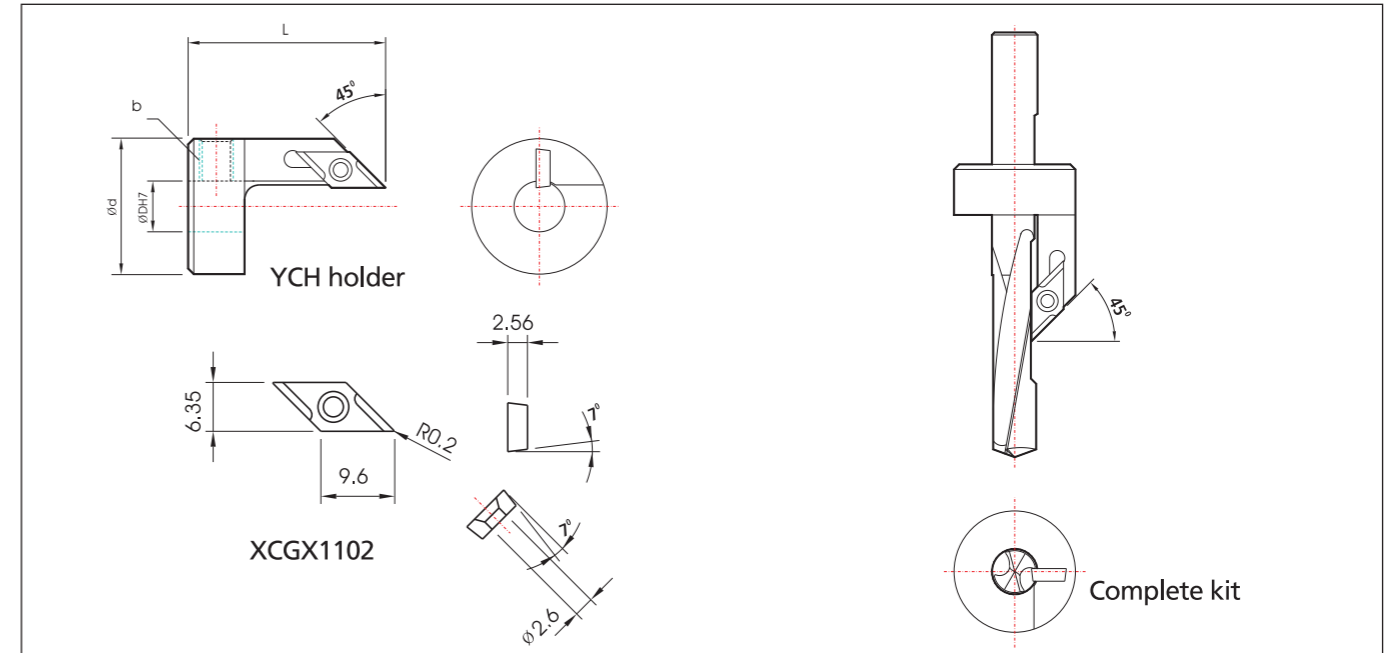

Code No.	D	d	L	Socket Screw Bolt size (b)	Applicable size range(YCD model)
YCH .2500	.2500	0.83	1.14	M6 x 1.0P	YCD .2010~.2720
YCH .3125	.3125	0.91	1.34		YCD .3125~.3320
YCH .3750	.3750	0.98	1.42		YCD .3680~.3906
YCH .4375	.4375	1.02	1.34	M8 x 1.25P	YCD .4219~.4531
YCH .5000	.5000	1.1	1.42		YCD .4844~.5156
YCH .5625	.5625	1.14	1.5		YCD .5312~.5781
YCH .6875	.6875	1.26	1.65	M10 x 1.5P	YCD .6562~.6875
YCH .7500	.7500	1.34	1.73		YCD .7656~.8125

❖ See page 63 of applicable YCD drill together with this model.

- YTEI** Indexable "ECO-Cutter" system
- IB,R** Carbide Ball radius Inserts
- IB,HR** Carbide Ball half-radius Inserts
- IE,R** Carbide End mill Inserts
- ICD** Carbide Center drill Inserts, 60°, 90°
- YSET** Solid Carbide End Mills
- YSEL** Solid Carbide End Mills, Long series
- YSET/HH** Solid Carbide High Helix End Mills
- YSER** Solid Carbide Roughing End Mills
- YSEB** Solid Carbide Ball End Mills
- YSEBL** Solid Carbide Ball End Mills, Long series
- YSEBG** Solid Carbide Ball End Mills for Graphite

# Carbide End Mills and Cutters



## Indexable "ECO-Cutter" system



**YTEI** "ECO-Cutter" Long Body



**YTEI,S** "ECO-Cutter" Short Body

**Model : YTEI**

- ▶ 5 Different insert cutters interchangeable in YTEI body
- ▶ Strong clamping with two locking screws
- ▶ New design with center stem(pin) on the insert to keep better centralization and run-out
- ▶ Body consists of heat-treated tool steel
- ▶ All carbide inserts ground completely by CNC & TiAlN
- ▶ Ball radius IB insert has precise helical fluted marginal cutting edge like drill to enable copy milling smoothly.
- ▶ Higher speed & feed available than conventional end mills.
- ▶ Dual purpose of roughing & finishing job

- IB, R** Ball radius 2 flute insert with round(oval)
- IB,HR** Ball radius 2 flute insert with half round
- IE, R** 2 flute end mill with corner radius
- ICD,90°** Center & chamfer drill insert with 90° point (dual point with 120°+90° for safer centering)
- ICD,60°** Center & chamfer drill insert with 60° point (dual point with 120°+60° for safer centering)

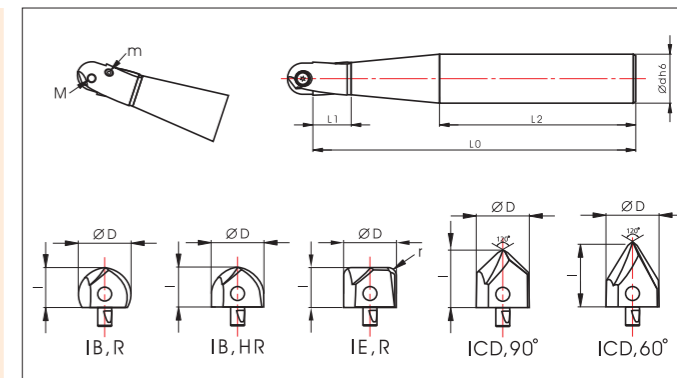

**ECO-Cutter recommended cutting data**

Work-piece	Cutting speed range (Vc=m/min.)	feed rate per flute (fz=mm/rev.)	IB,R/IB,HR Ball radius insert		Work-piece	Cutting speed range (Vc=m/min.)	feed rate per flute (fz=mm/rev.)	IE Flat milling insert	
			Ball Radius milling	Slot & Shoulder milling				Slot & Shoulder milling	Slot & Shoulder milling
			Φ8-12	Φ16-32				Φ8-20	Φ25-32
Cast Iron	100~200	0.3~0.4	Vc=150m/min. fz=0.35mm/flute ap=0.025mm, ae=0.1xD(Φ)	Vc=160m/min. fz=0.35mm/flute ap=0.05mm, ae=0.1xD(Φ)	Alloy & Carbon steel (Hardness below HRC40)	50~130	0.08~0.15	Vc=90m/min. fz=0.12mm/flute ap=0.5mm, ae=0.6xD(Φ)	Vc=90m/min. fz=0.12mm/flute ap=0.5mm, ae=0.6xD(Φ)
Die & Tool steel(Hardness HRC30~40)	60~100	0.1~0.15	Vc=90m/min. fz=0.1mm/flute ap=0.03mm, ae=0.1xD(Φ)	Vc=80m/min. fz=0.15mm/flute ap=0.05mm, ae=0.1xD(Φ)	Alloy & Carbon steel (Hardness below HRC30)	60~160	0.1~0.15	Vc=130m/min. fz=0.2mm/flute ap=0.5mm, ae=0.6xD(Φ)	Vc=130m/min. fz=0.2mm/flute ap=0.5mm, ae=0.6xD(Φ)
Alloy & Carbon steel (Hardness HRC30~40)	70~150	0.2~0.3	Vc=130m/min. fz=0.2mm/flute ap=0.03mm, ae=0.1xD(Φ)	Vc=110m/min. fz=0.3mm/flute ap=0.05mm, ae=0.1xD(Φ)	Normal Mild steel(Hardness below HB 200)	70~200	0.1~0.15	Vc=150m/min. fz=0.2mm/flute ap=1mm, ae=0.6xD(Φ)	Vc=150m/min. fz=0.2mm/flute ap=1mm, ae=0.6xD(Φ)
Alloy & Carbon steel (Hardness below HRC30)	100~200	0.2~0.3	Vc=150m/min. fz=0.2mm/flute ap=0.03mm, ae=0.1xD(Φ)	Vc=150m/min. fz=0.25mm/flute ap=0.06mm, ae=0.1xD(Φ)					
Hardened steel(Hardness HRC50~60)	200~250	0.2~0.4	Vc=200m/min. fz=0.25mm/flute ap=0.01mm, ae=0.1xD(Φ)	Vc=220m/min. fz=0.35mm/flute ap=0.01mm, ae=0.02xD(Φ)					

Work-piece	Cutting speed range (Vc=m/min.)	ICD Centering & Chamfering insert			
		Centering(Spotting)		Chamfering	
		Φ8-20	Φ25-32	Φ8-20	Φ25-32
Alloy & Carbon steel (Hardness below HRC40)	40~60	Vc=50m/min. f=0.1~0.15 mm/rev.	Vc=50m/min. f=0.1~0.15 mm/rev.	Vc=50m/min. fz=0.05mm/ flute	Vc=50m/min. fz=0.1mm/ flute
Alloy & Carbon steel (Hardness below HRC30)	50~80	Vc=70m/min f=0.1~0.2 mm/rev.	Vc=70m/min f=0.1~0.2 mm/rev.	Vc=70m/min fz=0.1mm/ flute	Vc=70m/min fz=0.12mm/ flute
Normal Mild steel(Hardness below HB 200)	80~200	Vc=120m/min f=0.1~0.3 mm/rev.	Vc=120m/min f=0.1~0.3 mm/rev.	Vc=120m/min fz=0.1mm/ flute	Vc=120m/min fz=0.15mm/ flute

Carbide End Mills and Cutters



# "ECO-Cutter" Long Body system

Body	Insert	ΦD	Φd	L0	L1	L2	I	R	r	M	m
YTEI 080	IB 080 R	8.0	10	94	12	60	6.19	4.0	-	M2	m2.5
	IB 080 HR										
	IE 080										
	ICD 080-90										
	ICD 080-60										
YTEI 100	IB 100 R	10.0	12	107	12	70	7.86	5.0	-	M2.5	m2.5
	IB 100 HR										
	IE 100										
	ICD 100-90										
	ICD 100-60										
YTEI 120	IB 120 R	12.0	16	131	11	90	9.16	6.0	-	M3	m3
	IB 120 HR										
	IE 120										
	ICD 120-90										
	ICD 120-60										
YTEI 160	IB 160 R	16.0	20	158	18	95	12.13	8.0	-	M4	m3
	IB 160 HR										
	IE 160										
	ICD 160-90										
	ICD 160-60										
YTEI 200	IB 200 R	20.0	25	165	20	100	15.10	10.0	-	M5	m4
	IB 200 HR										
	IE 200										
	ICD 200-90										
	ICD 200-60										
YTEI 250	IB 250 R	25.0	32	191	21	110	18.71	12.5	-	M6	m4
	IB 250 HR										
	IE 250										
	ICD 250-90										
	ICD 250-60										
YTEI 300	IB 300 R	30.0	32	227	32	120	22.74	15.0	-	M8	m5
	IB 300 HR										
	IE 300										
	ICD 300-90										
	ICD 300-60										
YTEI 320	IB 320 R	32.0	32	326	32	250	24.01	16.0	-	M8	m6
	IB 320 HR										
	IE 320										
	ICD 320-90										
	ICD 320-60										

# "ECO-Cutter" Short body system

Body	Insert	ΦD	Φd	L0	L1	L2	I	R	r	M	m
YTEI 080S	IB 080 R	8	8	74	12	50	6.19	4.0	-	M2	m2.5
	IB 080 HR										
	IE 080										
	ICD 080-90										
	ICD 080-60										
YTEI 090S	IB 090 R	9	10	93	13	65	6.83	4.5	-	M2	m2.5
	IB 090 HR										
	IE 090										
	ICD 090-90										
	ICD 090-60										
YTEI 100S	IB 100 R	10	10	92	12	65	7.86	5.0	-	M2.5	m2.5
	IB 100 HR										
	IE 100										
	ICD 100-90										
	ICD 100-60										
YTEI 110S	IB 110 R	11	12	99	16	68	8.51	5.5	-	M2.5	m2.5
	IB 110 HR										
	IE 110										
	ICD 110-90										
	ICD 110-60										
YTEI 120S	IB 120 R	12	12	99	16	68	9.16	6.0	-	M3	m3
	IB 120 HR										
	IE 120										
	ICD 120-90										
	ICD 120-60										
YTEI 130S	IB 130 R	13	16	98	15	68	9.80	6.5	-	M3	m3
	IB 130 HR										
	IE 130										
	ICD 130-90										
	ICD 130-60										
YTEI 140S	IB 140 R	14	16	98	15	68	10.43	7.0	-	M3	m3
	IB 140 HR										
	IE 140										
	ICD 140-90										
	ICD 140-60										
YTEI 150S	IB 150 R	15	16	109	19	75	11.49	7.5	-	M4	m3
	IB 150 HR										
	IE 150										
	ICD 150-90										
	ICD 150-60										
YTEI 160S	IB 160 R	16	16	108	18	75	12.13	8.0	-	M4	m3
	IB 160 HR										
	IE 160										
	ICD 160-90										
	ICD 160-60										
YTEI 170S	IB 170 R	17	16	107	17	70	12.77	8.5	-	M4	m3
	IB 170 HR										
	IE 170										
	ICD 170-90										
	ICD 170-60										
YTEI 180S	IB 180 R	18	16	106	21	70	13.82	9.0	-	M4	m3
	IB 180 HR										
	IE 180										
	ICD 180-90										
	ICD 180-60										
YTEI 190S	IB 190 R	19	16	106	21	70	14.46	9.5	-	M5	m3
	IB 190 HR										
	IE 190										
	ICD 190-90										
	ICD 190-60										
YTEI 200S	IB 200 R	20	16	105	20	70	15.10	10.0	-	M5	m3
	IB 200 HR										
	IE 200										
	ICD 200-90										
	ICD 200-60										
YTEI 250S	IB 250 R	25	25	141	21	105	18.71	12.5	-	M6	m4
	IB 250 HR										
	IE 250										
	ICD 250-90										
	ICD 250-60										
YTEI 300S	IB 300 R	30	25	137	32	90	22.74	15.0	-	M8	m5
	IB 300 HR										
	IE 300										
	ICD 300-90										
	ICD 300-60										
YTEI 320S	IB 320 R	32	25	136	31	90	24.01	16.0	-	M8	m6
	IB 320 HR										
	IE 320										
	ICD 320-90										
	ICD 320-60										



This body dimension is similar to conventional solid end mill. Same insert can be fit for both long & short body

Carbide End Mills and Cutters

Carbide End Mills and Cutters

# Solid Carbide End Mills

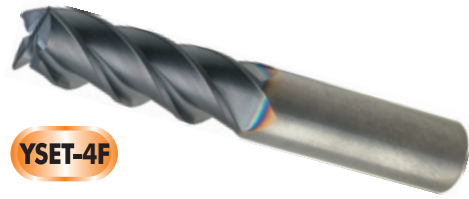

YSET-4F

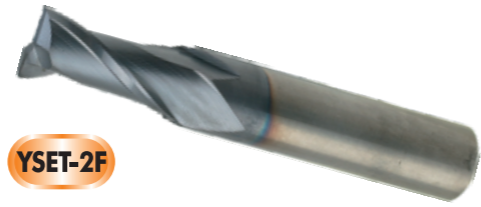

YSET-2F

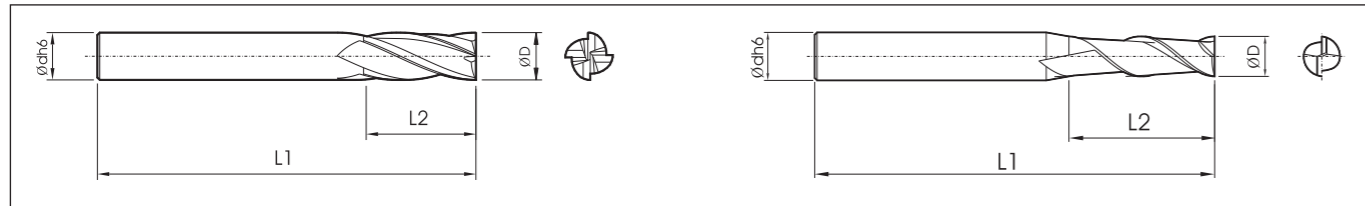

## Model : YSET, YSEL

- ▶ Standard length(YSET) & Long length(YSEL)
- ▶ Extra fine Micro grain carbide, PVD TiAlN coated to provide strength, lubricity, wear resistance and freer cutting action.
- ▶ 30° regular helix spiral, square end, 2 & 4 flutes configuration
- ▶ Suitable for high performance and high productivity machining
- ▶ Applicable to wide range materials

\* Ordering : Please mark number of flutes in the square blank.

(unit : mm)

Code No.	ΦD	Φd	L1	L2	Available flutes
<b>* Standard Length 2F, 4F</b>					
YSET 2020	2.0	6.0	40	6	2
YSET 2025	2.5			8	
YSET 2030	3.0		45	10	
YSET 2040	4.0			12	
YSET □050	5.0		50	15	
YSET □060	6.0				
YSET 2070	7.0	8.0	60	20	2
YSET □080	8.0				2, 4
YSET 2090	9.0	10.0	70	25	2
YSET □100	10.0				2, 4
YSET 2110	11.0	12.0	75	30	2
YSET □120	12.0				
YSET □140	14.0	16.0	80	35	2, 4
YSET □150	15.0				
YSET □160	16.0				
YSET □180	18.0	20.0	100	40	
YSET □200	20.0				
<b>* Long Length 2F, 4F</b>					
YSEL 2060	6.0	6.0	70	30	2
YSEL 2080	8.0	8.0	80	35	
YSEL 4100	10.0	10.0	108	40	4
YSEL 4120	12.0	12.0		45	
YSEL 4160	16.0	16.0	120	55	
YSEL 4200	20.0	20.0		60	
YSEL 4250	25.0	25.0	160	70	

# Carbide High Helix End Mills



YSET/HH

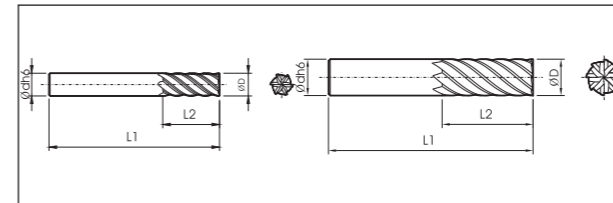

## Model : YSET, Multi-flutes

- ▶ Standard length, High helix 40°, multi-flutes 6F & 8F configuration
- ▶ Extra fine Micro grain carbide, PVD TiAlN coated to provide strength, lubricity, wear resistance and freer cutting action.
- ▶ Finish milling operation
- ▶ Suitable for high performance and high productivity machining
- ▶ Applicable to wide range of material up to HRC60

Code No.	ΦD	Φd	L1	L2	Number of flute
YSET 6060	6.0	6.0	50	15	6
YSET 6080	8.0	8.0	60	20	
YSET 6100	10.0	10.0	70	25	
YSET 6120	12.0	12.0	75	30	
YSET 6140	14.0	16.0	80	35	
YSET 8160	16.0		90	40	
YSET 8200	20.0	20.0	105	45	8
YSET 8250	25.0	25.0	130	50	
YSET 8320	32.0	32.0	150	65	

# Carbide Roughing End Mills



YSER

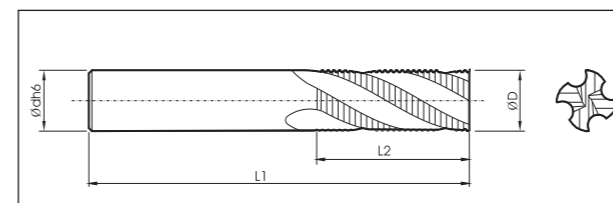

## Model : YSER

- ▶ Standard length, Regular helix 30°, 3, 4, 6 flute configuration
- ▶ Extra fine Micro grain carbide, PVD TiAlN coated to provide strength, lubricity, wear resistance and freer cutting action.
- ▶ Strongest cutting edge and smooth operation
- ▶ Applicable high feed rate in shoulder milling and slotting operation

Code No.	ΦD	Φd	L1	L2	Number of flute
YSER 3060	6.0	6.0	50	15	3
YSER 3080	8.0	8.0	60	20	
YSER 3100	10.0	10.0	70	25	
YSER 4120	12.0	12.0	75	30	4
YSER 4140	14.0	16.0	80	35	
YSER 4160	16.0		90	40	
YSER 6200	20.0	20.0	105	45	6
YSER 6250	25.0	25.0	130	50	



# Carbide Ball End Mills



**YSEB**   **YSEBL**

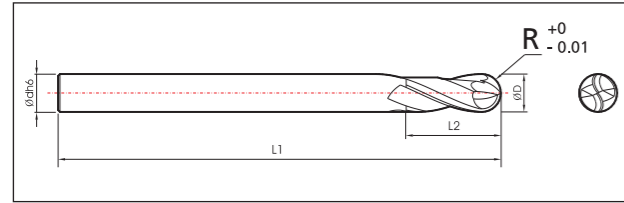

## Model : YSEB, YSEBL

- ▶ Ball nose End Mill, Standard length(YSEB) & Long/Extra Long length(YSEBL)
- ▶ Extra fine Micro grain carbide, PVD TiAlN coated to Provide Strength, lubricity, wear resistance and freer cutting action
- ▶ 30° regular helix spiral, 2 flutes configuration
- ▶ Special geometry with eccentric cutting edge, high tolerance radius +0 ~ - 0.01 mm
- ▶ Applicable to wide range of material up to HRC60
- ▶ Suitable for high performance and high productivity machining

(unit : mm)

Code No.	D	R	d	L1	L2
<b>* Standard Length</b>					
YSEB 1.0R	2.0	1.0	6	60	5
YSEB 1.5R	3.0	1.5			7
YSEB 2.0R	4.0	2.0			8
YSEB 2.5R	5.0	2.5			10
YSEB 3.0R	6.0	3.0	8	80	16
YSEB 3.5R	7.0	3.5			18
YSEB 4.0R	8.0	4.0	10	90	20
YSEB 4.5R	9.0	4.5			22
YSEB 5.0R	10.0	5.0	16	100	25
YSEB 6.0R	12.0	6.0			30
YSEB 7.0R	14.0	7.0	120	108	32
YSEB 8.0R	16.0	8.0			35
YSEB 10.0R	20.0	10.0	160	120	40
YSEB 12.5R	25.0	12.5			50
YSEB 16.0R	32.0	16.0	32	160	60
<b>* Long/Extra long Length</b>					
YSEBL 3.0R110	6.0	3.0	6	110	20
YSEBL 3.0R160				160	25
YSEBL 4.0R160	8.0	4.0	8	160	30
YSEBL 4.0R200				200	35
YSEBL 5.0R160	10.0	5.0	10	160	40
YSEBL 5.0R200				200	45
YSEBL 6.0R160	12.0	6.0	12	160	50
YSEBL 6.0R200				200	55
YSEBL 8.0R160	16.0	8.0	16	160	60
YSEBL 8.0R200				200	65
YSEBL 10.0R160	20.0	10.0	20	160	70
YSEBL 10.0R200				200	75
YSEBL 12.5R200	25.0	12.5	25	200	85
YSEBL 16.0R200	32.0	16.0	32	200	95

# Carbide Long Ball End Mills For graphite

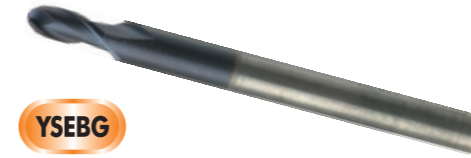

**YSEBG**

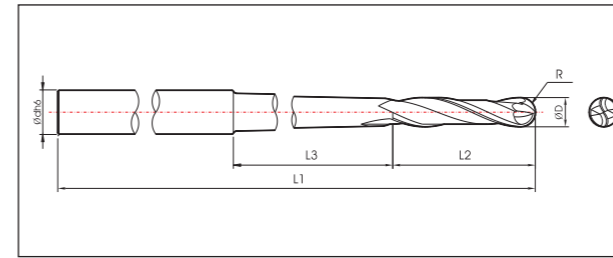

## Model : YSEBG

- ▶ Ball nose End Mill, Long length exclusively used for Graphite material
- ▶ Extra fine Micro grain carbide, PVD TiAlN coated to provide strength, lubricity, wear resistance and freer cutting action.
- ▶ 30° regular helix spiral, 2 flutes configuration
- ▶ Special geometry with eccentric cutting edge, high tolerance radius +0 ~ - 0.01mm
- ▶ Suitable for high performance and high productivity machining
- ▶ High strength TRS 4,300N/mm

(unit : mm)

Code No.	D	R	d	L1	L2	L3
YSEBG 1.0R160	2.0	1.0	6.0	160	6	95
YSEBG 1.5R160	3.0	1.5			8	80
YSEBG 2.0R160	4.0	2.0	10		85	
YSEBG 3.0R160	6.0	3.0	20		80	
YSEBG 3.0R200	3.0	1.5	10.0	200		
YSEBG 4.0R160	8.0	4.0	12.0	160	30	70
YSEBG 4.0R200				200		
YSEBG 5.0R160	10.0	5.0	12.0	160	40	55
YSEBG 5.0R200				200		
YSEBG 6.0R160	12.0	6.0	16.0	160	50	80
YSEBG 6.0R200				200		
YSEBG 8.0R200	16.0	8.0	20.0	200	60	85

Description	Page
Concentricity	85
Collant supply	85
Cutting Data for YTDI, YTD	86
Cutting Data for YSD, YSDC(D5)	87
Cutting Data for YSET	88
Cutting Data for YSET/HH, YSER	89
Speed Formula	90
Drilling for Stacked Plate	90
Chip Formation	90
Speed examples	91
Maximum Wear	91
Power Requirement	92
Trouble Shooting	93
Resharpener Guide	94
Test Report Form (English)	96
Test Report Form (Korean)	97

## Concentricity

► To achieve the tolerance required or eliminate trouble, total run out between the center line of tool and workpiece must not exceed the below value.

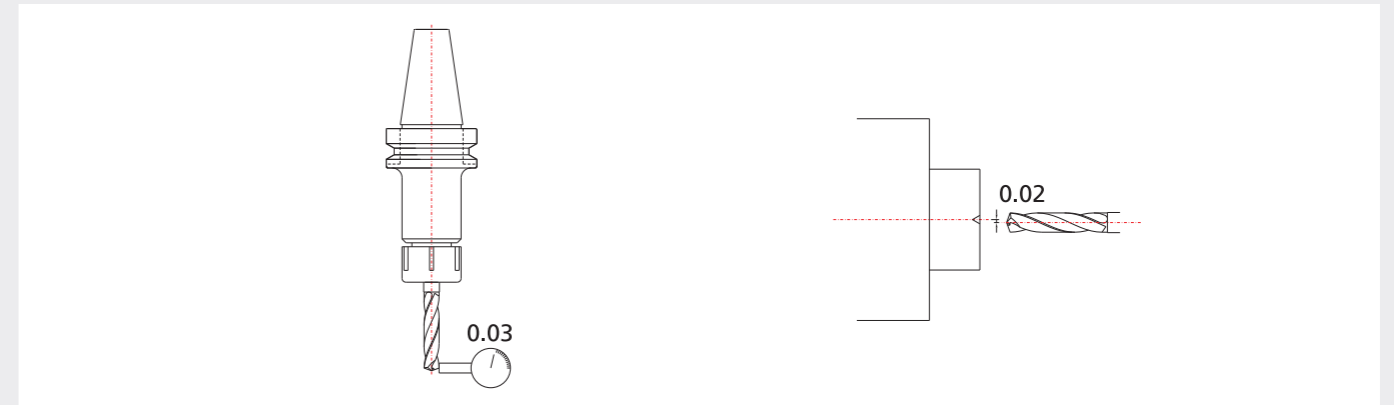

## External coolant supply

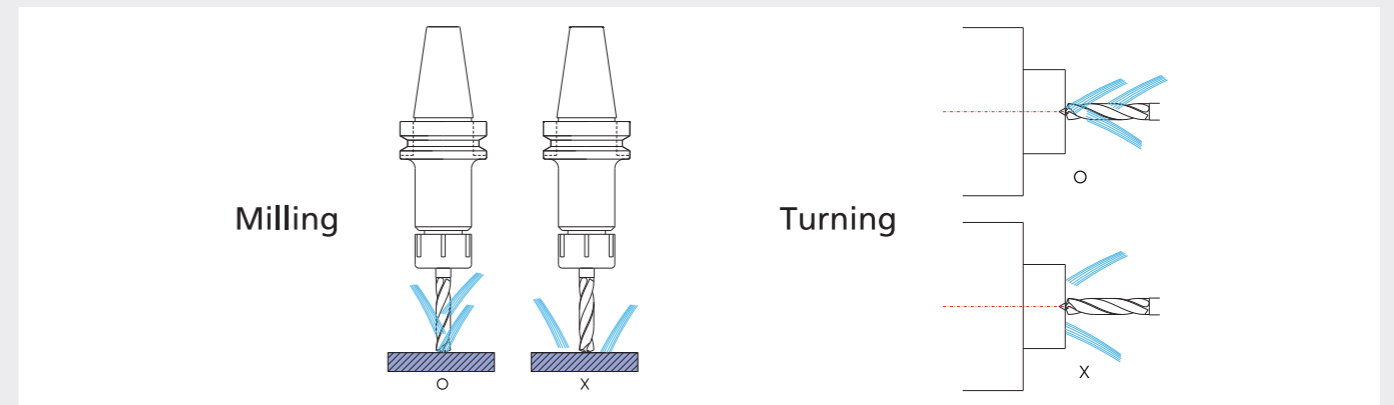

## Internal Coolant supply

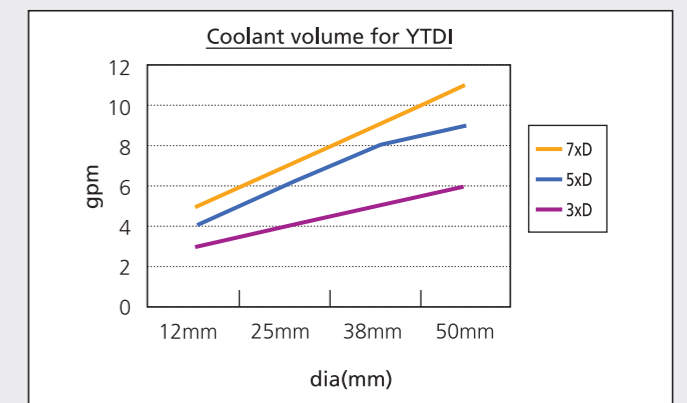
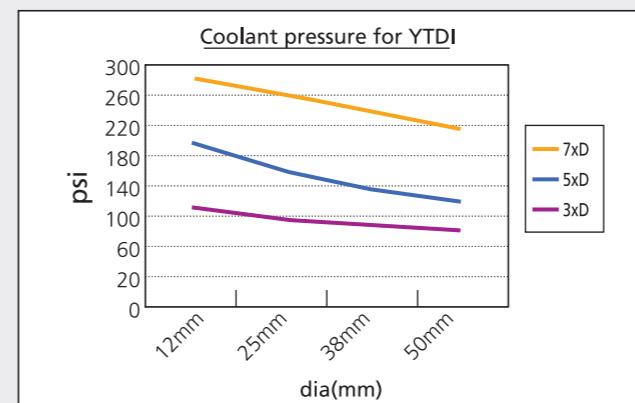

Coolant Pressure(psi) for YTDI drill

	12mm	25mm	38mm	50mm
3xD	116	109	102	94
5xD	218	210	203	196
7xD	290	276	260	247

Coolant Volume(gpm) for YTDI drill

	12mm	25mm	38mm	50mm
3xD	3	4	5	6
5xD	4	6	8	9
7xD	5	7	9	11



# Recommended Cutting Data

► Feeds and Speed for starting point only. It is recommended to use these values as a starting point until optimal results are obtained.

## YTDI Indexable Drills, Metric

Material Group	Drill Dia.	8~16mm		16~25mm		25~32mm		32~40mm		40~50mm	
		Speed (m/min)	Feed (mm/rev)	Speed (m/min)	Feed (mm/rev)	Speed (m/min)	Feed (mm/rev)	Speed (m/min)	Feed (mm/rev)	Speed (m/min)	Feed (mm/rev)
Grey cast iron (FC)		50~70	0.20~0.30	50~70	0.25~0.45	50~80	0.35~0.55	60~90	0.34~0.58	80~100	0.38~0.60
Nodular cast iron (FCD)		40~65	0.15~0.25	40~65	0.22~0.45	45~75	0.32~0.52	50~80	0.35~0.62	70~100	0.38~0.60
Carbon steel (S45C)		55~70	0.15~0.30	55~70	0.16~0.40	60~85	0.20~0.40	70~90	0.22~0.48	75~95	0.25~0.54
Alloy steel (SCM440)		50~75	0.15~0.30	50~75	0.15~0.40	55~80	0.18~0.40	60~90	0.25~0.47	65~95	0.27~0.52
Hardened steel (SKD11)		40~50	0.10~0.20	40~50	0.12~0.28	40~50	0.16~0.35	40~60	0.20~0.38	40~60	0.22~0.42
Stainless steel (SUS)		30~40	0.10~0.20	35~50	0.10~0.22	35~50	0.15~0.28	40~55	0.18~0.30	40~55	0.22~0.32
Aluminum 130HB (AL)		80~100	0.20~0.30	80~100	0.25~0.40	90~110	0.30~0.45	90~110	0.30~0.45	90~120	0.30~0.50

► The data is recommended for 3xDia. and should be slightly reduced for 5xD & 7xD drills.

## YTDI Indexable Drills, Inches

Material Group	Drill Dia.	.3150~.6299		.6299~.9843		.9843~1.2598		1.2598~1.5748		1.5748~1.9685	
		Speed (SFM)	Feed (IPR)	Speed (SFM)	Feed (IPR)	Speed (SFM)	Feed (IPR)	Speed (SFM)	Feed (IPR)	Speed (SFM)	Feed (IPR)
Grey cast iron (FC)		160~230	0.008~0.012	160~230	0.010~0.018	160~260	0.014~0.022	200~300	0.013~0.023	260~330	0.015~0.024
Nodular cast iron (FCD)		130~210	0.006~0.010	130~210	0.009~0.018	150~240	0.013~0.021	160~260	0.014~0.025	230~330	0.015~0.024
Carbon steel (S45C)		180~230	0.006~0.012	180~230	0.006~0.016	200~280	0.008~0.016	230~300	0.009~0.019	240~310	0.010~0.021
Alloy steel (SCM440)		160~240	0.006~0.012	160~240	0.006~0.016	180~260	0.007~0.016	200~300	0.010~0.009	210~310	0.011~0.021
Hardened steel (SKD11)		130~160	0.004~0.008	130~160	0.005~0.011	130~160	0.006~0.014	130~200	0.008~0.015	130~200	0.009~0.017
Stainless steel (SUS)		100~130	0.004~0.008	110~160	0.004~0.009	110~160	0.006~0.011	130~160	0.007~0.012	130~180	0.009~0.013
Aluminum 130HB (AL)		260~330	0.008~0.01	260~330	0.010~0.016	300~360	0.012~0.018	300~360	0.012~0.018	300~390	0.012~0.020

## YTD Carbide Brazed Tipped Drills, Metric

Material Group	Drill Dia.	13.5~15.0mm		~20.0mm		~41.5mm	
		Speed (m/min)	Feed (mm/rev)	Speed (m/min)	Feed (mm/rev)	Speed (m/min)	Feed (mm/rev)
Grey cast iron (FC)		50~80	0.20~0.35	50~80	0.20~0.40	50~80	0.25~0.50
Nodular cast iron (FCD)		50~70	0.20~0.35	50~70	0.20~0.40	50~70	0.25~0.50
Carbon steel (S45C)		40~65	0.15~0.30	40~65	0.20~0.40	40~65	0.20~0.45
Alloy steel (SCM440)		40~60	0.10~0.25	40~60	0.15~0.35	40~60	0.20~0.40
Hardened steel (SKD11)		30~40	0.10~0.25	30~40	0.15~0.30	30~40	0.20~0.35
Stainless steel (SUS)		30~40	0.10~0.20	30~40	0.15~0.25	30~40	0.20~0.30

## YSD, YSDF, YSDP, YCD Solid Carbide Drills

Material Group	Drill Dia.	3~5mm		5~8mm		8~10mm		10~12mm		12~14mm		14~20mm	
		Speed	Feed	Speed	Feed	Speed	Feed	Speed	Feed	Speed	Feed	Speed	Feed
Grey cast iron (FC)		80~85	0.1~0.25	80~90	0.2~0.3	85~95	0.2~0.35	90~95	0.2~0.4	90~100	0.2~0.4	95~100	0.2~0.5
Nodular cast iron (FCD)		80~85	0.1~0.25	80~85	0.2~0.3	80~85	0.2~0.35	80~90	0.2~0.4	80~90	0.2~0.4	80~90	0.2~0.5
Carbon steel (S45C)		60~65	0.1~0.2	65~70	0.15~0.25	70~75	0.15~0.25	70~80	0.2~0.3	70~80	0.25~0.3	75~80	0.3~0.4
Alloy steel (SCM440)		50~55	0.1~0.25	55~60	0.15~0.25	60~65	0.15~0.3	60~70	0.2~0.35	65~70	0.25~0.35	65~70	0.3~0.45
Hardened steel (SKD11)		25~30	0.06~0.12	25~30	0.1~0.15	30~35	0.1~0.2	30~35	0.1~0.25	30~35	0.1~0.25	30~35	0.1~0.25
Stainless steel (SUS)		20~25	0.05~0.1	20~25	0.1~0.15	25~30	0.1~0.2	25~30	0.1~0.25	25~30	0.1~0.25	25~30	0.1~0.25

## YSDC(D5), YSDCF(D5), YSDCP(D5) Solid Coolant Hole Drills

Materials	speed (V) (m/min)	Feed rate in dia.				
		3~8mm	8~12mm	12~16mm	16~20mm	
Unalloyed steel	Carbon < 0.25%	80~100	0.1~0.2	0.15~0.25	0.2~0.4	0.25~0.5
	Carbon : 0.25~0.55%	80~100	0.1~0.2	0.15~0.25	0.2~0.4	0.25~0.5
	High Carbon & Carbon tool steel	80~100	0.1~0.2	0.15~0.25	0.2~0.4	0.25~0.5
Low alloyed steel	Non hardened HB 150~260	70~100	0.1~0.2	0.2~0.3	0.2~0.35	0.25~0.4
High alloyed steel	Annealed HSS HB 150~270	40~70	0.08~0.15	0.12~0.22	0.2~0.4	0.25~0.4
Stainless steel	Austenitic Ni>8%, C=18~25%	35~50	0.08~0.15	0.12~0.25	0.15~0.3	0.2~0.35
Malleable cast iron	Ferritic	80~100	0.15~0.3	0.25~0.35	0.3~0.4	0.3~0.45
	Pearlitic	70~90	0.1~0.25	0.2~0.4	0.25~0.4	0.25~0.5
Grey cast iron	Low tensile strength	80~100	0.1~0.25	0.25~0.35	0.3~0.45	0.35~0.55
	High tensile strength	70~90	0.1~0.22	0.2~0.33	0.3~0.4	0.35~0.5



1. YES Carbide drill is not recommended to operate in low powered equipment.
2. Check spindle, machine and fixture rigidity before operation.
3. Make sure that coincide drill point with the center of material when lathe operation.
4. Feed enough cutting fluids.

# Recommended Cutting Data

## YSET Carbide End Mills

Diameter (mm)	Condition Flutes	Carbon steel (S50C) (Speed = 40m/min)			Alloy steel (SCM, SKD, SUS) (Speed = 30m/min)		
		rpm	Feed(mm/min)		rpm	Feed(mm/min)	
			Slot	Shoulder		Slot	Shoulder
2.0	2	5,600	80	200	4,800	60	150
2.5	2	4,500	80	200	3,800	60	150
3.0	2	3,700	80	200	3,200	60	150
4.0	2	2,800	80	200	2,400	60	150
5.0	2	2,200	80	200	1,900	60	150
	4		-	300		-	230
6.0	2	1,900	80	200	1,600	60	150
	4		-	300		-	230
7.0	2	1,600	80	200	1,400	60	150
8.0	2	1,400	80	200	1,200	60	150
	4		-	300		-	230
9.0	2	1,200	80	200	1,100	60	150
10.0	2	1,100	80	200	950	60	150
	4		-	300		-	230
11.0	2	1,000	80	200	870	60	150
12.0	2	930	80	200	800	60	150
	4		-	300		-	230
14.0	2	800	80	200	680	60	150
	4		-	300		-	230
15.0	2	750	80	200	640	60	150
	4		-	300		-	230
16.0	2	700	80	200	600	60	150
	4		-	300		-	230
18.0	2	620	80	200	530	60	150
	4		-	300		-	230
20.0	2	560	80	200	480	60	150
	4		-	300		-	230

## YSET Carbide Roughing End Mills

Diameter	Condition	Carbon steel (S50C) (Speed = 40m/min)		Alloy steel (SCM, SKD, SUS) (Speed = 30m/min)			
		rpm	Feed(mm/min)		rpm	Feed(mm/min)	
			Slot	Shoulder		Slot	Shoulder
6		2100	120	300	1600	100	250
8		1600	120	300	1200	100	250
10		1300	120	300	950	100	250
12		1100	120	300	800	100	250
14		900	120	300	680	100	250
16		800	120	300	600	100	250
20		640	100	250	480	80	200
25		510	100	250	380	80	200

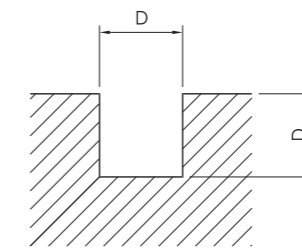

Slot Milling

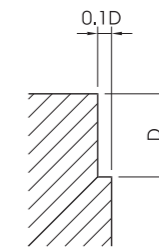

Shoulder Milling

## YSET/HH Carbide High Helix End Mills

Diameter	Condition	HRC 55 v=25m/min		HRC 60 v=20m/min		HRC 65 v=15m/min		HRC 70 v=12m/min	
		rpm	Feed	rpm	Feed	rpm	Feed	rpm	Feed
6		1300	200	1100	160	800	120	640	100
8		1000	200	800	160	600	120	480	100
10		800	200	640	160	480	120	380	100
12		600	200	530	160	400	120	320	100
16		500	200	400	160	300	120	240	100
20		400	200	320	160	240	120	200	100
25		320	200	250	160	190	120	150	100
32		270	200	210	160	160	120	130	100



# Speed formula, Drilling of stacked plate, Chip formation

## Major Cutting speed formula

### Cutting Speed

$$V = \frac{\pi \times D \times N}{1000} \text{ (m/min)}$$

- V : Cutting speed (m/min)
- D : Drill diameter (mm)
- N : Revolution per minute (rpm)
- $\pi$  : Circular constant (3.14)

### Feed

$$f = \frac{F}{N} \text{ (mm/rev)}$$

- f : Feed rate (mm/rev)
- F : Depth of cut per minute (mm/min)
- N : Revolution per minute (rpm)

## Recommended application for stacked plate by Yes Carbide Drills

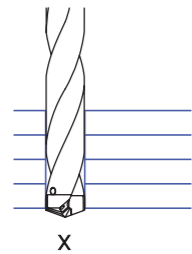

One operation is possible subject to closely tightend stacked plate without any room.

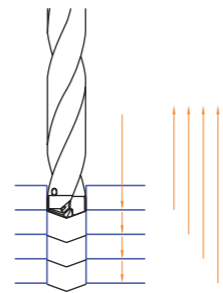

"Woodpecker" method recommended in case of certain aperture in the stacked plate.

## Good chip formation

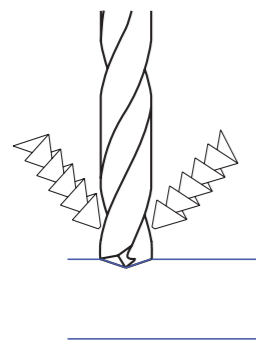

(initial drilling)

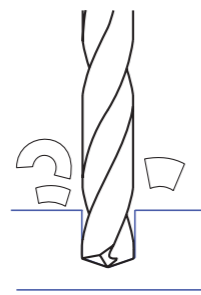

(drilling through)

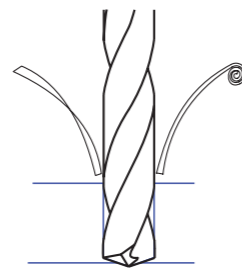

(bottoming)

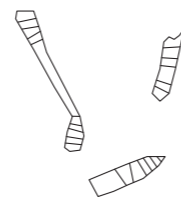

(long Stringy chip)

# Speed Examples, Maximum Wear

## Cutting speed examples for different workpieces by Yes Carbide drills

<p>Φ13 x depth 10mm</p>	<p><b>FCD45</b> <b>YCD 130</b> N=1592rpm V=65m/min F=318mm/min f=0.2mm/rev</p>	<p>Φ20 x depth 70mm</p>	<p><b>S50C</b> <b>YTDI 200 P</b> N=876rpm V=55m/min F=263mm/min f=0.3mm/rev</p>
<p>Φ24 x depth 63mm</p>	<p><b>SS41</b> <b>YTDI 240 T</b> N=796rpm V=60m/min F=239mm/min f=0.3mm/rev</p>	<p>Φ12 x depth 12mm</p>	<p><b>SCM440</b> <b>YSD 120</b> N=1194rpm V=45m/min F=179mm/min f=0.15mm/rev</p>
<p>Φ10 x depth 15mm</p>	<p><b>SUS304</b> <b>YSDC 100</b> N=1115rpm V=35m/min F=112mm/min f=0.1mm/rev</p>	<p>Φ15 x depth 8mm</p>	<p><b>FC25</b> <b>YTD 150</b> N=1592rpm V=75m/min F=557mm/min f=0.35mm/rev</p>

## How to find maximum wear

1. When long and stringy chip formation without broken chip, require to change new tool or regrinding
2. Below pictures show the time of regrinding

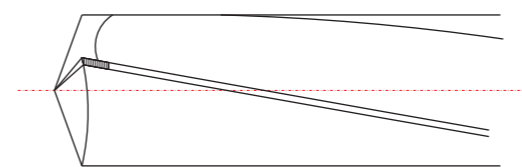

Need to change new tool or regrinding

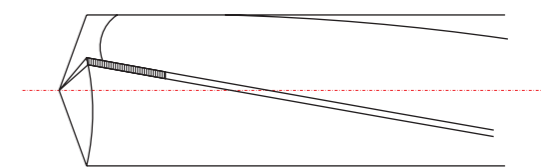

Excessive wear

## Power requirement for YES Carbide Drills

$$\text{Power(P)} = \frac{D \times f \times V \times k_s}{24,480 \times 0.7} \text{ (kw)}$$

ex)

$$\text{Power(P)} = \frac{11.5 \times 0.2 \times 60 \times 230}{24,480 \times 0.7} = 1.852 \text{kw}$$

- D = drill diameter (mm)
- f = feed (mm/rev)
- V = cutting speed (m/min)
- ks = specific cutting force (kg/mm)
- η = constants of performance(0.7~0.85)

### Specific cutting force (ks)

Material	Condition	HB	ks(kg/mm)	
Steel	Unalloyed steel	C = 0.15%	100~150	195
		C = 0.35%	120~180	215
		C = 0.60%	200~250	230
	Low alloy steel	Non hardened	120~200	215
		Hardened & Tempered	250~300	265
		Hardened & Tempered	300~350	290
	High alloy steel	Annealed	150~250	265
		Hardened	300~350	290
	Stainless steel	Martensitic/ ferritic	175~225	235
		Austenitic	150~200	250
	Steel casting	Unalloyed	150~200	205
		Low alloyed	175~225	255
High alloyed		200~250	275	
Hard steel	Hardened steel	HRc 55	460	
Cast iron	Grey casting iron	Low tensile strength	150~225	110
		High tensile strength	200~300	150
	Malleable cast iron		110~250	115
	Nodular cast iron	Ferritic	125~200	115
		Pearlitic	200~300	185
Chilled cast iron		350~450	310	
Non ferrous	Aluminium alloys	Non heat treatable	40~80	50
		Heat treatable	80~120	80
	Aluminium alloys,Cast	Non heat treatable	50~100	80
		Heat treatable	65~115	95
	Copper alloys	Brass	65~115	80
		Bronze	75~115	180

Problem	Cause	Remedy	
Cutting edge wear	Flank wear	Excessive cutting speed	Reduce cutting speed
	Edge chipping	Vibration or chattering in machine tool, holder or component	Check and adjust machine and tool alignment
		Deflection of tool, part, fixture or machine	Check all rigidity
		Excessive cutting speed	Reduce cutting speed
		Off center set up	Check concentricity not to exceed 0.02mm TIR
	Corner chipping	Excessive cutting speed	Reduce cutting speed
		Insufficient coolant supply	Increase coolant pressure
	Built up edge	Insufficient cutting speed	Increase cutting speed
		Insufficient coolant supply	Increase coolant pressure
		Worn cutting edge	Regrind or replace new drill
	Margin	Improper seating of tool	Check and adjust machine spindle, and fixture
		Rough or angled entry/exit of hole	Reduce feed
		Chip clogging or jamming	Increase coolant pressure and adjust feed to optimize chip-formation
		Insufficient coolant supply	Increase coolant pressure
Excessive cutting speed		Reduce cutting speed	
Long stringy chips	Improper speed and feed	Adjust speed and feed	
Tool life too short	Flank wear increase too fast	Reduce cutting speed	
Drill breakage	Off center set up	Check set up rigidity of machine, tool, and fixture	
	Improper cutting condition	Check cutting parameters, possibly reduce feed	
Burrs on exit	Excessive axial force	Reduce the width of edge preparation	
Oversize hole	Improper cutting condition	Check cutting data, increase cutting speed	
	Clamping chuck	Check fit and clamping of tool	
Undersize hole	Tool cooling	Check coolant fluid	
	Improper cutting condition	Reduce cutting speed, increase feed	



# Resharpener Guide for YES Carbide Drills

Yes brand Carbide drill can be resharpened by CNC 5 axis machine or Universal tool grinder with our own special attachment. The below procedure is to regrind by Universal tool grinder, while follow "S" point program in case of CNC machine.

## Removal of worn section

Remove all of the worn or chipped section before regrinding.

## Regrinding drill point

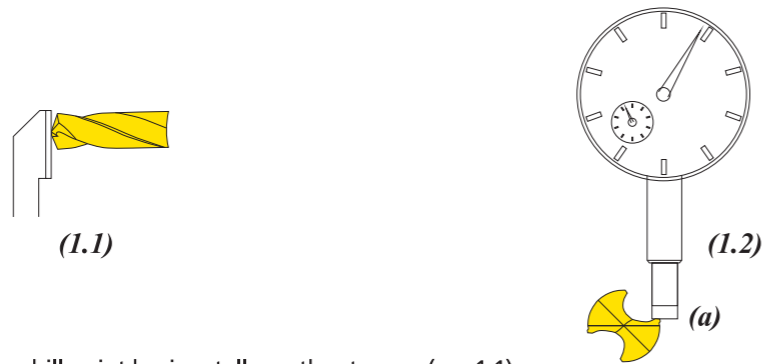

1. Put the drill point horizontally on the stopper.(see 1.1)
2. Set dial gauge on <a> and turn the drill to coincide central line of point. Then, tighten the collect chuck securely.(see 1.2)

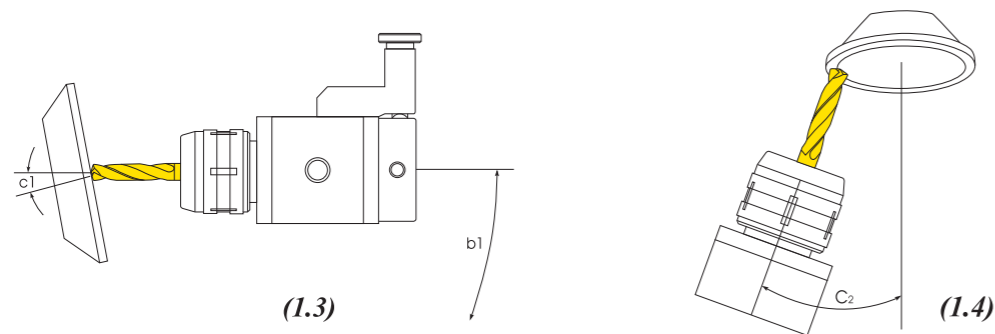

3. Set the cutting edge toward grinding wheel to the point angle <c1, 8°> as shown (1.3). Then, keep the angle <c2, 20°> as shown (1.4).
4. Grind the flank up and down repeatedly as shown <b1>.

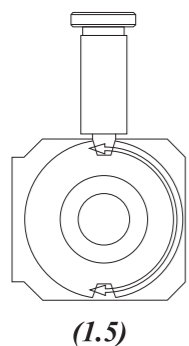

5. Move forward the grinding wheel and grind the cutting lips, after keeping the attachment horizontally.
6. Rotate the attachment at 180° toward <c3> and grind other cutting edge by the same procedure as NO.4, 5.(see 1.5) Make sure that both cutting lips should be equal or symmetrical.

## Web thinning

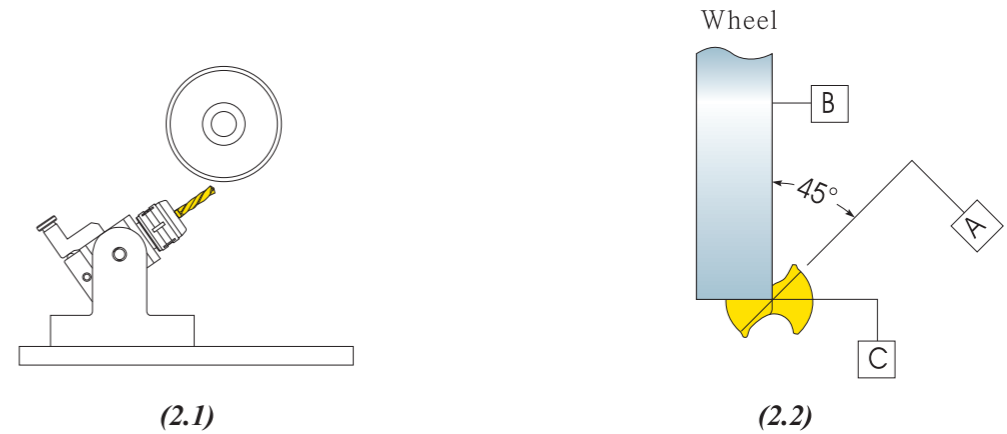

1. Set the drill at 30° or 35° in the drill attachment.(see 2.1) (In case of drill for AL, FC material, keep 30°, while others at 35°.)
2. Align the "B" face of wheel at center line of drill.(see 2.2)
3. Set the "B" face of wheel at 45° from central line of the drill.

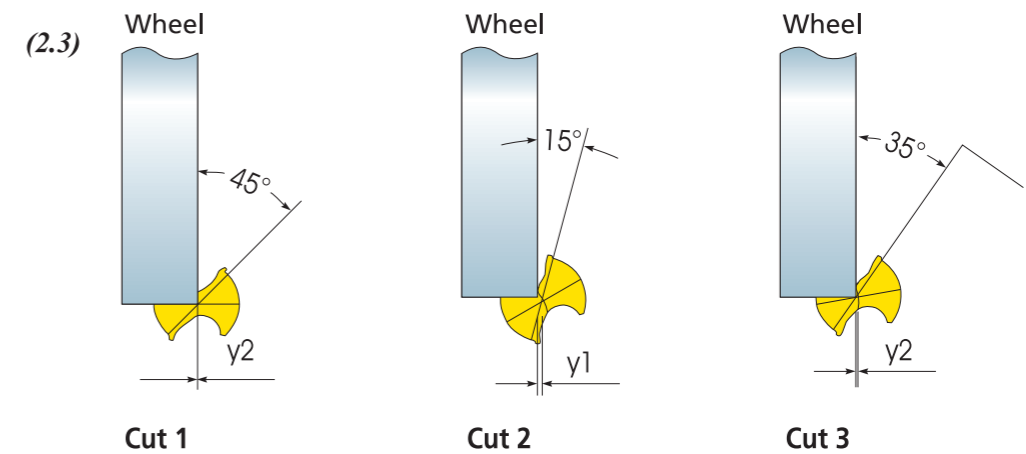

4. Grind as procedure <cut 1>,<cut 2>, <cut3>.(see 2.3)
5. Rotate the attachment at 180° and grind other facet by NO.4 procedure. Note that the shape of the thinning should be such that it does not interfere with chip flow.



**Note**  
If you have any difficulty to regrind in your shop, you may use our factory expert service which is being serviced at reasonable cost in one week returning delivery Contact ours.

# Test Report Form

**Yes**® YESTOOL Co., Ltd.

❖ ADD : 189,Seonggok-ro, Danwon-Gu, Ansan-si, Gyeonggi-do, Korea  
 ❖ Tel : +82-31-493-2387~8 ❖ Fax : +82-31-494-7619  
 ❖ e-mail : yestool@yestool.co.kr ❖ www.yestool.com

COMPANY AND LOCATION	PHONE	DATE	ENGINEER NAME
CUSTOMER NAME	PHONE	MATERIAL TYPE AND CONDITION	HARDNESS RC BRN
PART DESCRIPTION	THROUGH OR FLOOD COOLANT <input type="checkbox"/> <input type="checkbox"/>	DRILLING POSITION HORIZONTAL <input type="checkbox"/> VERTICAL <input type="checkbox"/>	
MACHINE AND TYPE	COOLANT TYPE BRAND	COOLANT PRESSURE PSI	COOLANT FLOW GPM
MACHINE CONDITION	HP	HOLE PURPOSE TAPPED <input type="checkbox"/> CLEARANCE <input type="checkbox"/> ROUGH HOLE BORING <input type="checkbox"/>	
OPERATION			

PERFORMANCE, TECHNICAL, AND COST DATA	YES INDEXABLE DRILL	COMPETITOR'S
DRILL BRAND		
DRILL TYPE & DIAMETER		
TOOLHOLDING DEVICE		
INSERT OR BLADE		
INSERT GRADE & BRAND		
HOLE DIAMETER AND TOLERANCE(ROUGH)		
HOLE DIAMETER AND TOLERANCE(FINISH)		
HOLE DEPTH BLIND YES NO		
RPM		
SPEED (V: m/min)		
FEED RATE (f: mm/rev)		
FEED (F: mm/min)		
CUTTING TIME PER HOLE IN MINUTES		
CHIP CONTROL		
SURFACE FINISH		
NUMBER OF HOLES PER EDGE		
LINEAR METERS DRILLED PER EDGE		
REASON FOR CHANGING DRILL		
INSERT (BLADES) PER DRILL		
INDEXES PER INSERT		
INSERT COST		
PROJECTED RECONDITIONS PER BLADE		
RECONDITION COST		
MACHINE COST PER HOUR		
HOLES PER PART		
ESTIMATED PARTS PER YEAR		

# Test Report Form

**Yes**® YESTOOL Co., Ltd.

❖ 경기도 안산시 단원구 성곡로 189 (주)에스툴  
 ❖ Tel : 031-493-2387~8 ❖ Fax : 031-494-7619  
 ❖ e-mail : yestool@yestool.co.kr ❖ www.yestool.com

회사및공장	전화	일시	담당기사
고객명	전화	가공재질및특성	경도 RC BRN
제품명	내부절삭유급 외부절삭유 <input type="checkbox"/> <input type="checkbox"/>	드릴링형태 수평형 <input type="checkbox"/> 수직형 <input type="checkbox"/>	
기계명	절삭유 제품명	절삭유압력 PSI	절삭유량 GPM
기계상태	마력(HP)	홀작업사유 탭전드릴 <input type="checkbox"/> 정삭홀작업 <input type="checkbox"/> 황삭홀작업 <input type="checkbox"/>	
기계의작동			

PERFORMANCE, TECHNICAL, AND COST DATA	YES INDEXABLE DRILL	타사제품
드릴 제조회사		
드릴의 종류 및 직경		
피삭재 고정방법		
인서트형 드릴 또는 솔리드 드릴		
인서트 종류 및 제조원		
황삭가공 경 및 공차		
정삭가공 경 및 공차		
홀 깊이 막힌홀 관통홀		
회전수(rpm)		
절삭 속도 V (m/분)		
이송량 f (mm/rev)		
분당 이송량 F (mm/분)		
홀당 가공시간(분)		
칩형성 모양		
홀 거칠기		
드릴당 가공 홀 수		
드릴당 가공 거리(수명)		
드릴의 교체 사유		
드릴당 인서트 교체수량		
INDEXES PER INSERT		
인서트 비용		
드릴의 재연마 계획		
재연마 재코팅 비용		
시간당 기계 비용		
제품당 소요되는 홀의 수		
연간 제품 소요량		

Technical Data

Technical Data



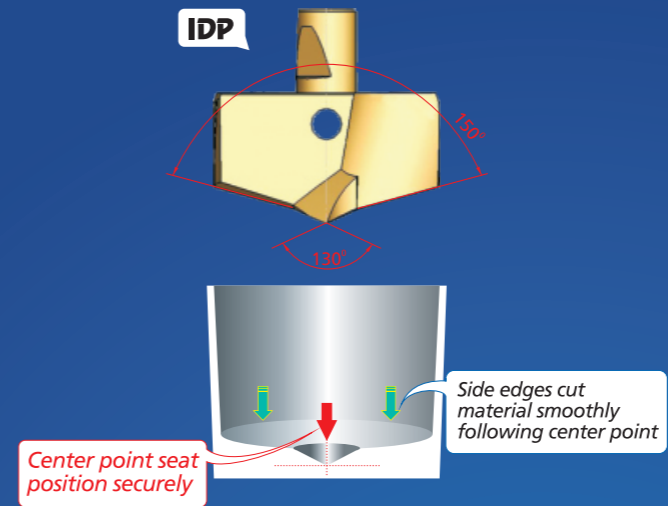
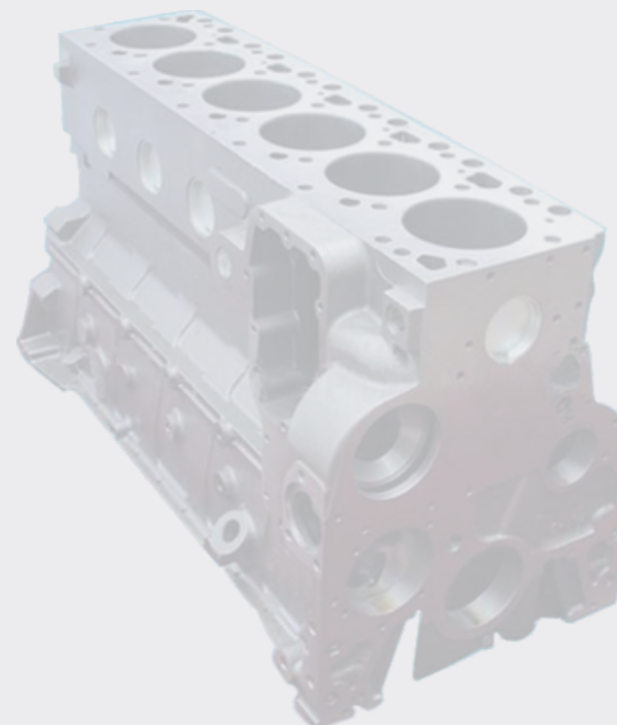
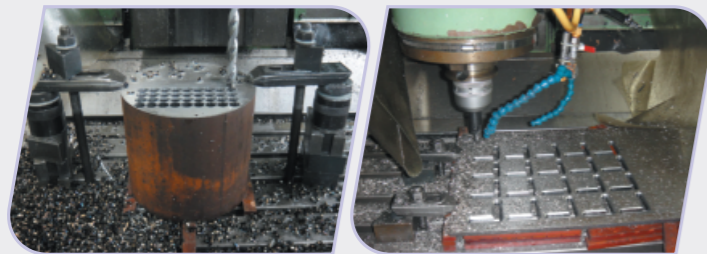
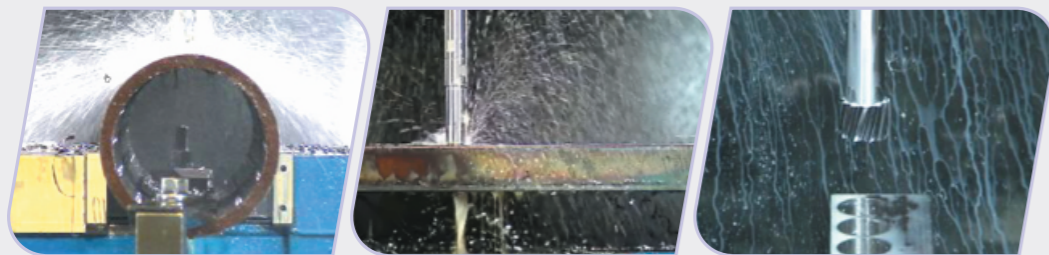
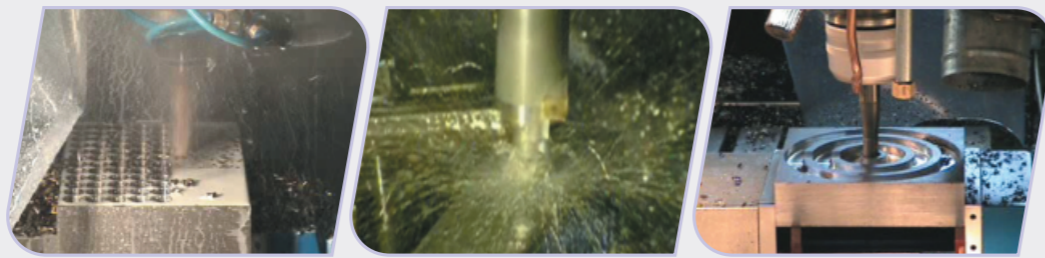
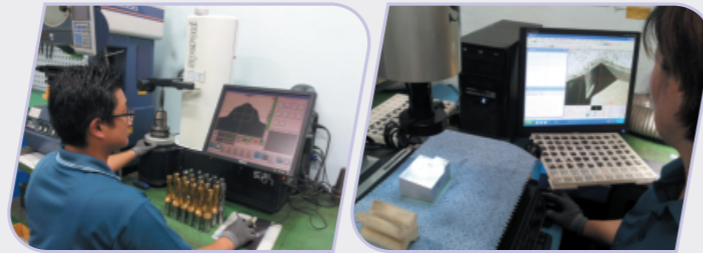

Your Metal Cutting  
**Solution by**  
**Yes<sup>®</sup> Carbide Cutting Tools**