

# KSD-W

KSD-W Indexable Insert Drill (4xD)  
KSD-W 舍弃式快速钻头 (4倍长)

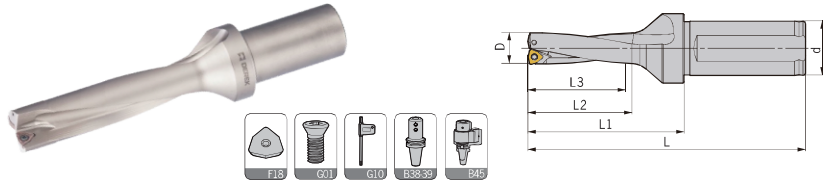

型号 Specification	刃数 Teeth	D	d	L <sub>1</sub>	L <sub>2</sub>	L <sub>3</sub>	L	刀片 Insert	刀片螺钉 Insert screw	旗形扳手 Wrench	重量 Weight
KSD-C40-400-4-W	2	40	40	196	166	160	266	WCMX080412	M040W090	Q15B	1.78
C40-410-4-W	2	41	40	200	170	164	270	WCMX080412	M040W090	Q15B	1.88
C40-420-4-W	2	42	40	204	174	168	274	WCMX080412	M040W090	Q15B	1.92
C40-430-4-W	2	43	40	208	178	172	278	WCMX080412	M040W090	Q15B	2.04
C40-440-4-W	2	44	40	212	182	176	282	WCMX080412	M040W090	Q15B	2.20
C40-450-4-W	2	45	40	216	186	180	286	WCMX080412	M040W090	Q15B	2.32
C40-460-4-W	2	46	40	220	190	184	290	WCMX080412	M040W090	Q15B	2.38
C40-470-4-W	2	47	40	224	194	188	294	WCMX080412	M040W090	Q15B	2.41
C40-480-4-W	2	48	40	228	198	192	298	WCMX080412	M040W090	Q15B	2.53
C40-490-4-W	2	49	40	232	202	196	302	WCMX080412	M040W090	Q15B	2.56
C40-500-4-W	2	50	40	236	206	200	306	WCMX080412	M040W090	Q15B	2.69
C40-510-4-W	2	51	40	240	210	204	310	WCMX080412	M040W090	Q15B	2.83
C40-520-4-W	2	52	40	244	214	208	314	WCMX080412	M040W090	Q15B	2.84
C40-530-4-W	2	53	40	248	218	212	318	WCMX080412	M040W090	Q15B	3.05
C40-540-4-W	2	54	40	252	222	216	322	WCMX080412	M040W090	Q15B	3.23
C40-550-4-W	2	55	40	256	226	220	326	WCMX080412	M040W090	Q15B	3.28
C40-560-4-W	2	56	40	260	230	224	330	WCMX080412	M040W090	Q15B	3.43
C40-570-4-W	2	57	40	264	234	228	334	WCMX080412	M040W090	Q15B	3.63
C40-580-4-W	2	58	40	268	238	232	338	WCMX080412	M040W090	Q15B	3.77
C40-590-4-W	2	59	40	272	242	236	342	WCMX080412	M040W090	Q15B	3.82
C40-600-4-W	2	60	40	276	246	240	346	WCMX080412	M040W090	Q15B	3.97
C40-610-4-W	2	61	40	280	250	244	350	WCMX080412	M040W090	Q15B	4.10

适用 Suitable: 德克或住友刀片 DEREK Or SUMITOMO Insert

# KSD-S

KSD-S Indexable Insert Drill (3xD)  
KSD-S 舍弃式快速钻头 (3倍长)

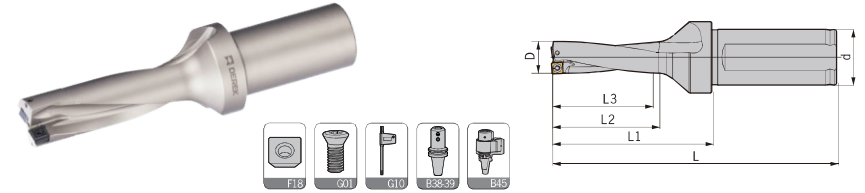

型号 Specification	刃数 Teeth	D	d	L <sub>1</sub>	L <sub>2</sub>	L <sub>3</sub>	L	刀片 Insert	刀片螺钉 Insert screw	旗形扳手 Wrench	重量 Weight
KSD-C25-150-3-S	2	15	25	72	48	45	128	SPMT050204	M020W040	Q08B	0.32
C25-155-3-S	2	15.5	25	72	48	45	128	SPMT060204	M022W050	Q08B	0.32
C25-160-3-S	2	16	25	75	51	48	131	SPMT060204	M022W050	Q08B	0.33
C25-165-3-S	2	16.5	25	75	51	48	131	SPMT060204	M022W050	Q08B	0.34
C25-170-3-S	2	17	25	78	54	51	134	SPMT060204	M022W050	Q08B	0.34
C25-175-3-S	2	17.5	25	78	54	51	134	SPMT060204	M022W050	Q08B	0.35
C25-180-3-S	2	18	25	81	57	54	137	SPMT060204	M022W050	Q08B	0.36
C25-185-3-S	2	18.5	25	81	57	54	137	SPMT060204	M022W050	Q08B	0.36
C25-190-3-S	2	19	25	84	60	57	140	SPMT060204	M022W050	Q08B	0.37
C25-195-3-S	2	19.5	25	84	60	57	140	SPMT060204	M022W050	Q08B	0.37
C32-200-3-S	2	20	32	91	64	60	151	SPMT060204	M022W050	Q08B	0.57
C32-205-3-S	2	20.5	32	91	64	60	151	SPMT060204	M022W050	Q08B	0.57
C32-210-3-S	2	21	32	94	67	63	154	SPMT060204	M022W050	Q08B	0.58
C32-215-3-S	2	21.5	32	94	67	63	154	SPMT060204	M022W050	Q08B	0.58
C32-220-3-S	2	22	32	97	70	66	157	SPMT07T308	M025W070	Q08B	0.60
C32-225-3-S	2	22.5	32	97	70	66	157	SPMT07T308	M025W070	Q08B	0.60
C32-230-3-S	2	23	32	100	73	69	160	SPMT07T308	M025W070	Q08B	0.61
C32-235-3-S	2	23.5	32	100	73	69	160	SPMT07T308	M025W070	Q08B	0.62
C32-240-3-S	2	24	32	103	76	72	163	SPMT07T308	M025W070	Q08B	0.64
C32-245-3-S	2	24.5	32	103	76	72	163	SPMT07T308	M025W070	Q08B	0.65
C32-250-3-S	2	25	32	106	79	75	166	SPMT07T308	M025W070	Q08B	0.66
C32-255-3-S	2	25.5	32	106	79	75	166	SPMT07T308	M025W070	Q08B	0.66
C32-260-3-S	2	26	32	109	82	78	169	SPMT07T308	M025W070	Q08B	0.70
C32-265-3-S	2	26.5	32	109	82	78	169	SPMT07T308	M025W070	Q08B	0.70
C32-270-3-S	2	27	32	112	85	81	172	SPMT07T308	M025W070	Q08B	0.71
C32-275-3-S	2	27.5	32	112	85	81	172	SPMT07T308	M025W070	Q08B	0.73
C32-280-3-S	2	28	32	115	88	84	175	SPMT090408	M035W090	Q15B	0.75
C32-285-3-S	2	28.5	32	115	88	84	175	SPMT090408	M035W090	Q15B	0.76
C32-290-3-S	2	29	32	118	91	87	178	SPMT090408	M035W090	Q15B	0.77
C32-300-3-S	2	30	32	121	94	90	181	SPMT090408	M035W090	Q15B	0.81
C32-310-3-S	2	31	32	127	97	93	187	SPMT090408	M035W090	Q15B	0.84
C32-320-3-S	2	32	32	130	100	96	190	SPMT090408	M035W090	Q15B	0.88
C32-330-3-S	2	33	32	133	103	99	193	SPMT090408	M035W090	Q15B	0.93

适用 Suitable: 德克或特固克刀片 DEREK Or TAE GUTEC Insert

转下页  
See next page

# KSD-S

KSD-S Indexable Insert Drill (3xD)  
KSD-S 舍弃式快速钻头 (3倍长)

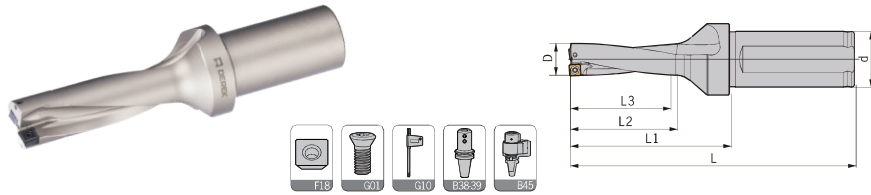

型号 Specification	刃数 Teeth	D	d	L1	L2	L3	L	刀片 Insert	刀片螺钉 Insert screw	旗形扳手 Wrench	重量 Weight
KSD-C32-340-3-S	2	34	32	136	106	102	196	SPMT110408	M040W090	Q15B	0.94
C32-350-3-S	2	35	32	139	109	105	199	SPMT110408	M040W090	Q15B	0.95
C32-360-3-S	2	36	32	142	112	108	202	SPMT110408	M040W090	Q15B	1.06
C32-370-3-S	2	37	32	145	115	111	205	SPMT110408	M040W090	Q15B	1.06
C32-380-3-S	2	38	32	148	118	114	208	SPMT110408	M040W090	Q15B	1.06
C32-390-3-S	2	39	32	151	121	117	211	SPMT110408	M040W090	Q15B	1.17
C40-400-3-S	2	40	40	156	126	120	226	SPMT110408	M040W090	Q15B	1.64
C40-410-3-S	2	41	40	159	129	123	229	SPMT110408	M040W090	Q15B	1.64
C40-420-3-S	2	42	40	162	132	126	232	SPMT140512	M050Y110-1	Q20B	1.70
C40-430-3-S	2	43	40	165	135	129	235	SPMT140512	M050Y110-1	Q20B	1.77
C40-440-3-S	2	44	40	168	138	132	238	SPMT140512	M050Y110-1	Q20B	1.81
C40-450-3-S	2	45	40	171	141	135	241	SPMT140512	M050Y110-1	Q20B	1.81
C40-460-3-S	2	46	40	174	144	138	244	SPMT140512	M050Y110-1	Q20B	1.96
C40-470-3-S	2	47	40	177	147	141	247	SPMT140512	M050Y110-1	Q20B	2.04
C40-480-3-S	2	48	40	180	150	144	250	SPMT140512	M050Y110-1	Q20B	2.11
C40-490-3-S	2	49	40	183	183	147	253	SPMT140512	M050Y110-1	Q20B	2.20
C40-500-3-S	2	50	40	186	186	150	256	SPMT140512	M050Y110-1	Q20B	2.28
C40-510-3-S	2	51	40	189	189	153	259	SPMT07T308	M025W070	Q08B	2.30
C40-520-3-S	2	52	40	192	192	156	262	SPMT07T308	M025W070	Q08B	2.40
C40-530-3-S	2	53	40	195	195	159	265	SPMT07T308	M025W070	Q08B	2.42
C40-540-3-S	2	54	40	198	198	162	268	SPMT07T308	M025W070	Q08B	2.46
C40-550-3-S	2	55	40	201	201	165	271	SPMT07T308	M025W070	Q08B	2.56
C40-560-3-S	2	56	40	204	204	168	274	SPMT07T308	M025W070	Q08B	2.79
C40-570-3-S	2	57	40	207	207	171	277	SPMT090408	M035W090	Q15B	2.79
C40-580-3-S	2	58	40	210	210	174	280	SPMT090408	M035W090	Q15B	2.95
C40-590-3-S	2	59	40	213	213	177	283	SPMT090408	M035W090	Q15B	3.18
C40-600-3-S	2	60	40	216	216	180	286	SPMT090408	M035W090	Q15B	3.22
C40-610-3-S	2	61	40	219	219	183	289	SPMT090408	M035W090	Q15B	3.38
C40-620-3-S	2	62	40	222	222	186	292	SPMT090408	M035W090	Q15B	3.47
C40-630-3-S	2	63	40	225	225	189	295	SPMT090408	M035W090	Q15B	3.56
C40-640-3-S	2	64	40	228	228	192	298	SPMT090408	M035W090	Q15B	3.72
C40-650-3-S	2	65	40	231	231	195	301	SPMT090408	M035W090	Q15B	3.94
C40-660-3-S	2	66	40	234	234	198	304	SPMT090408	M035W090	Q15B	4.01
C40-670-3-S	2	67	40	237	237	201	307	SPMT110408	M040W090	Q15B	4.23
C40-680-3-S	2	68	40	240	240	204	310	SPMT110408	M040W090	Q15B	4.28
C40-690-3-S	2	69	40	243	243	207	313	SPMT110408	M040W090	Q15B	4.49
C40-700-3-S	2	70	40	246	246	210	316	SPMT110408	M040W090	Q15B	4.60

适用 Suitable: 德克或特固克刀片 DEREK Or TAEGUTEC Insert

# KSD-S

KSD-S Indexable Insert Drill (4xD)  
KSD-S 舍弃式快速钻头 (4倍长)

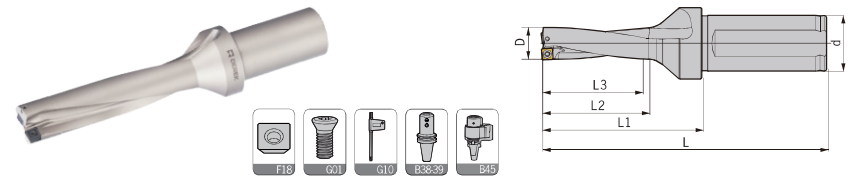

型号 Specification	刃数 Teeth	D	d	L1	L2	L3	L	刀片 Insert	刀片螺钉 Insert screw	旗形扳手 Wrench	重量 Weight
KSD-C25-160-4-S	2	16	25	92	58	64	148	SPMT060204	M022W050	Q06B	0.35
C25-165-4-S	2	16.5	25	92	58	64	148	SPMT060204	M022W050	Q06B	0.35
C25-170-4-S	2	17	25	96	72	68	152	SPMT060204	M022W050	Q06B	0.35
C25-175-4-S	2	17.5	25	96	72	68	152	SPMT060204	M022W050	Q06B	0.36
C25-180-4-S	2	18	25	100	76	72	156	SPMT060204	M022W050	Q06B	0.37
C25-185-4-S	2	18.5	25	100	76	72	156	SPMT060204	M022W050	Q06B	0.38
C25-190-4-S	2	19	25	104	80	76	160	SPMT060204	M022W050	Q06B	0.39
C25-195-4-S	2	19.5	25	104	80	76	160	SPMT060204	M022W050	Q06B	0.39
C32-200-4-S	2	20	32	111	84	80	171	SPMT060204	M022W050	Q06B	0.58
C32-205-4-S	2	20.5	32	111	84	80	171	SPMT060204	M022W050	Q06B	0.59
C32-210-4-S	2	21	32	115	88	84	175	SPMT060204	M022W050	Q06B	0.60
C32-215-4-S	2	21.5	32	115	88	84	175	SPMT060204	M022W050	Q06B	0.61
C32-220-4-S	2	22	32	119	92	88	179	SPMT07T308	M025W070	Q08B	0.63
C32-225-4-S	2	22.5	32	119	92	88	179	SPMT07T308	M025W070	Q08B	0.63
C32-230-4-S	2	23	32	123	96	92	183	SPMT07T308	M025W070	Q08B	0.65
C32-235-4-S	2	23.5	32	123	96	92	183	SPMT07T308	M025W070	Q08B	0.66
C32-240-4-S	2	24	32	127	100	96	187	SPMT07T308	M025W070	Q08B	0.67
C32-245-4-S	2	24.5	32	127	100	96	187	SPMT07T308	M025W070	Q08B	0.68
C32-250-4-S	2	25	32	131	104	100	191	SPMT07T308	M025W070	Q08B	0.69
C32-255-4-S	2	25.5	32	131	104	100	191	SPMT07T308	M025W070	Q08B	0.71
C32-260-4-S	2	26	32	135	108	104	195	SPMT07T308	M025W070	Q08B	0.74
C32-265-4-S	2	26.5	32	135	108	104	195	SPMT07T308	M025W070	Q08B	0.75
C32-270-4-S	2	27	32	139	112	108	199	SPMT07T308	M025W070	Q08B	0.77
C32-280-4-S	2	28	32	143	116	112	203	SPMT090408	M035W090	Q15B	0.81
C32-290-4-S	2	29	32	147	120	116	207	SPMT090408	M035W090	Q15B	0.84
C32-300-4-S	2	30	32	151	124	120	211	SPMT090408	M035W090	Q15B	0.87
C32-310-4-S	2	31	32	158	128	124	218	SPMT090408	M035W090	Q15B	0.91
C32-320-4-S	2	32	32	162	132	128	222	SPMT090408	M035W090	Q15B	0.97
C32-330-4-S	2	33	32	166	136	132	226	SPMT090408	M035W090	Q15B	1.00

适用 Suitable: 德克或特固克刀片 DEREK Or TAEGUTEC Insert

转下页  
See next page

# KSD-S

KSD-S Indexable Insert Drill (4xD)  
KSD-S 舍弃式快速钻头 (4倍长)

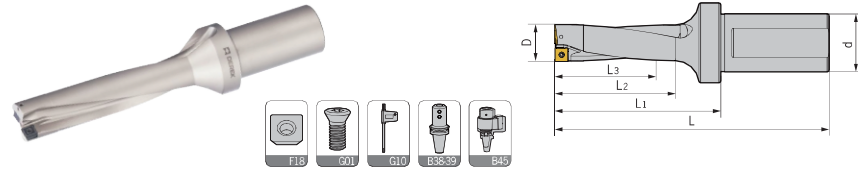

型号 Specification	刃数 Teeth	D	d	L <sub>1</sub>	L <sub>2</sub>	L <sub>3</sub>	L	刀片 Insert	刀片螺钉 Insert screw	旗形扳手 Wrench	重量 Weight
KSD- C32-340-4-S	2	34	32	170	140	136	230	SPMT110408	M040W090	Q15B	1.03
C32-350-4-S	2	35	32	174	144	140	234	SPMT110408	M040W090	Q15B	1.08
C32-360-4-S	2	36	32	178	144	144	238	SPMT110408	M040W090	Q15B	1.12
C32-370-4-S	2	37	32	182	152	148	242	SPMT110408	M040W090	Q15B	1.19
C32-380-4-S	2	38	32	186	156	152	246	SPMT110408	M040W090	Q15B	1.23
C32-390-4-S	2	39	32	190	160	156	250	SPMT110408	M040W090	Q15B	1.25
C40-400-4-S	2	40	40	196	166	160	266	SPMT110408	M040W090	Q15B	1.78
C40-410-4-S	2	41	40	200	170	164	270	SPMT110408	M040W090	Q15B	1.88
C40-420-4-S	2	42	40	204	174	168	274	SPMT140512	M050Y110-1	Q20B	1.92
C40-430-4-S	2	43	40	208	178	172	278	SPMT140512	M050Y110-1	Q20B	2.04
C40-440-4-S	2	44	40	212	182	176	282	SPMT140512	M050Y110-1	Q20B	2.20
C40-450-4-S	2	45	40	216	186	180	286	SPMT140512	M050Y110-1	Q20B	2.32
C40-460-4-S	2	46	40	220	190	184	290	SPMT140512	M050Y110-1	Q20B	2.38
C40-470-4-S	2	47	40	224	194	188	294	SPMT140512	M050Y110-1	Q20B	2.41
C40-480-4-S	2	48	40	228	198	192	298	SPMT140512	M050Y110-1	Q20B	2.53
C40-490-4-S	2	49	40	232	202	196	302	SPMT140512	M050Y110-1	Q20B	2.56
C40-500-4-S	2	50	40	236	204	200	306	SPMT140512	M050Y110-1	Q20B	2.69
C40-510-4-S	2	51	40	240	204	204	310	SPMT07T308	M025W070	Q08B	2.79
C40-520-4-S	2	52	40	244	208	208	314	SPMT07T308	M025W070	Q08B	2.84
C40-530-4-S	2	53	40	248	212	212	318	SPMT07T308	M025W070	Q08B	3.05
C40-540-4-S	2	54	40	252	216	216	322	SPMT07T308	M025W070	Q08B	3.23
C40-550-4-S	2	55	40	256	220	220	326	SPMT07T308	M025W070	Q08B	3.28
C40-560-4-S	2	56	40	260	224	224	330	SPMT07T308	M025W070	Q08B	3.43
C40-570-4-S	2	57	40	264	228	228	334	SPMT090408	M035W090	Q15B	3.63
C40-580-4-S	2	58	40	268	232	232	338	SPMT090408	M035W090	Q15B	3.77
C40-590-4-S	2	59	40	272	236	236	342	SPMT090408	M035W090	Q15B	3.82
C40-600-4-S	2	60	40	276	240	240	346	SPMT090408	M035W090	Q15B	3.97
C40-610-4-S	2	61	40	280	244	244	350	SPMT090408	M035W090	Q15B	4.10

适用 Suitable: 德克或特固克刀片 DEREK Or TAEGUTEC Insert

# KSD-S

KSD-S Indexable Insert Drill (5xD)  
KSD-S 舍弃式快速钻头 (5倍长)

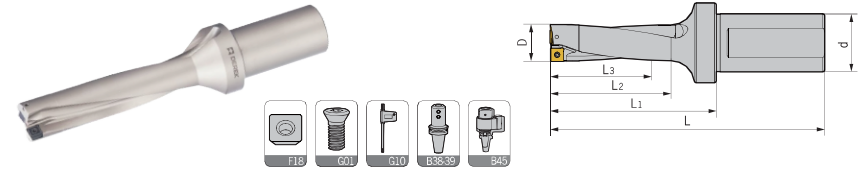

型号 Specification	刃数 Teeth	D	d	L <sub>1</sub>	L <sub>2</sub>	L <sub>3</sub>	L	刀片 Insert	刀片螺钉 Insert screw	旗形扳手 Wrench	重量 Weight
KSD- C25-160-5-S	2	16	25	107	83	80	163	SPMT060204	M022W050	Q06B	0.37
C25-165-5-S	2	16.5	25	107	83	80	163	SPMT060204	M022W050	Q06B	0.37
C25-170-5-S	2	17	25	112	88	85	168	SPMT060204	M022W050	Q06B	0.37
C25-175-5-S	2	17.5	25	112	88	85	168	SPMT060204	M022W050	Q06B	0.38
C25-180-5-S	2	18	25	117	93	90	173	SPMT060204	M022W050	Q06B	0.39
C25-185-5-S	2	18.5	25	117	93	90	173	SPMT060204	M022W050	Q06B	0.4
C25-190-5-S	2	19	25	122	98	95	178	SPMT060204	M022W050	Q06B	0.41
C25-195-5-S	2	19.5	25	122	98	95	178	SPMT060204	M022W050	Q06B	0.41
C32-200-5-S	2	20	32	131	104	100	191	SPMT060204	M022W050	Q06B	0.59
C32-205-5-S	2	20.5	32	131	104	100	191	SPMT060204	M022W050	Q06B	0.6
C32-210-5-S	2	21	32	136	109	105	196	SPMT060204	M022W050	Q06B	0.62
C32-215-5-S	2	21.5	32	136	109	105	196	SPMT060204	M022W050	Q06B	0.64
C32-220-5-S	2	22	32	141	114	110	201	SPMT07T308	M025W070	Q08B	0.66
C32-225-5-S	2	22.5	32	141	114	110	201	SPMT07T308	M025W070	Q08B	0.66
C32-230-5-S	2	23	32	146	119	115	206	SPMT07T308	M025W070	Q08B	0.69
C32-235-5-S	2	23.5	32	146	119	115	206	SPMT07T308	M025W070	Q08B	0.7
C32-240-5-S	2	24	32	151	124	120	211	SPMT07T308	M025W070	Q08B	0.7
C32-245-5-S	2	24.5	32	151	124	120	211	SPMT07T308	M025W070	Q08B	0.73
C32-250-5-S	2	25	32	156	129	125	216	SPMT07T308	M025W070	Q08B	0.73
C32-255-5-S	2	25.5	32	156	129	125	216	SPMT07T308	M025W070	Q08B	0.76
C32-260-5-S	2	26	32	161	134	130	221	SPMT07T308	M025W070	Q08B	0.78
C32-265-5-S	2	26.5	32	161	134	130	221	SPMT07T308	M025W070	Q08B	0.8
C32-270-5-S	2	27	32	166	139	135	226	SPMT07T308	M025W070	Q08B	0.83
C32-280-5-S	2	28	32	171	144	140	231	SPMT090408	M035W090	Q15B	0.87
C32-290-5-S	2	29	32	176	149	145	236	SPMT090408	M035W090	Q15B	0.91
C32-300-5-S	2	30	32	181	154	150	241	SPMT090408	M035W090	Q15B	0.93
C32-310-5-S	2	31	32	189	159	155	249	SPMT090408	M035W090	Q15B	0.98
C32-320-5-S	2	32	32	194	164	160	254	SPMT090408	M035W090	Q15B	1.06
C32-330-5-S	2	33	32	199	169	165	259	SPMT090408	M035W090	Q15B	1.07

适用 Suitable: 德克或特固克刀片 DEREK Or TAEGUTEC Insert

转下页  
See next page

# KSD-S

KSD-S Indexable Insert Drill (5xD)  
KSD-S 舍弃式快速钻头 (5倍长)

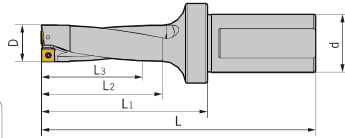

型号 Specification	刃数 Teeth	D	d	L <sub>1</sub>	L <sub>2</sub>	L <sub>3</sub>	L	刀片 Insert	刀片螺钉 Insert screw	旗形扳手 Wrench	重量 Weight
KSD- C32-340-5-S	2	34	32	204	174	170	264	SPMT110408	M040W090	Q15B	1.12
C32-350-5-S	2	35	32	209	179	175	269	SPMT110408	M040W090	Q15B	1.21
C32-360-5-S	2	36	32	214	184	180	274	SPMT110408	M040W090	Q15B	1.27
C32-370-5-S	2	37	32	219	189	185	279	SPMT110408	M040W090	Q15B	1.32
C32-380-5-S	2	38	32	224	194	190	284	SPMT110408	M040W090	Q15B	1.4
C32-390-5-S	2	39	32	229	199	195	289	SPMT110408	M040W090	Q15B	1.44
C40-400-5-S	2	40	40	236	206	200	306	SPMT110408	M040W090	Q15B	1.92
C40-410-5-S	2	41	40	241	211	205	311	SPMT110408	M040W090	Q15B	2.12
C40-420-5-S	2	42	40	246	216	210	316	SPMT140512	M050Y110-1	Q20B	2.14
C40-430-5-S	2	43	40	251	221	215	321	SPMT140512	M050Y110-1	Q20B	2.31
C40-440-5-S	2	44	40	256	226	220	326	SPMT140512	M050Y110-1	Q20B	2.59
C40-450-5-S	2	45	40	261	231	225	331	SPMT140512	M050Y110-1	Q20B	2.83
C40-460-5-S	2	46	40	266	236	230	336	SPMT140512	M050Y110-1	Q20B	2.88
C40-470-5-S	2	47	40	271	241	235	341	SPMT140512	M050Y110-1	Q20B	2.95
C40-480-5-S	2	48	40	276	246	240	346	SPMT140512	M050Y110-1	Q20B	3.01
C40-490-5-S	2	49	40	281	251	245	351	SPMT140512	M050Y110-1	Q20B	3.08
C40-500-5-S	2	50	40	286	256	250	356	SPMT140512	M050Y110-1	Q20B	3.13
C40-510-5-S	2	51	40	291	261	255	361	SPMT07T308	M025W070	Q08B	3.23
C40-520-5-S	2	52	40	296	266	260	366	SPMT07T308	M025W070	Q08B	3.28
C40-530-5-S	2	53	40	301	271	265	371	SPMT07T308	M025W070	Q08B	3.48
C40-540-5-S	2	54	40	306	276	270	376	SPMT07T308	M025W070	Q08B	3.67
C40-550-5-S	2	55	40	311	281	275	381	SPMT07T308	M025W070	Q08B	3.72
C40-560-5-S	2	56	40	316	286	280	386	SPMT07T308	M025W070	Q08B	3.87
C40-570-5-S	2	57	40	321	291	285	391	SPMT090408	M035W090	Q15B	4.07
C40-580-5-S	2	58	40	326	296	290	396	SPMT090408	M035W090	Q15B	4.21
C40-590-5-S	2	59	40	331	301	295	401	SPMT090408	M035W090	Q15B	4.26
C40-600-5-S	2	60	40	336	306	300	406	SPMT090408	M035W090	Q15B	4.41
C40-610-5-S	2	61	40	341	311	305	411	SPMT090408	M035W090	Q15B	4.52

适用 Suitable: 德克或特固克刀片 DEREK Or TAEGUTEC Insert

# HSK-DCK

HSK-DCK Boring Adapter  
HSK-DCK 镗头刀柄

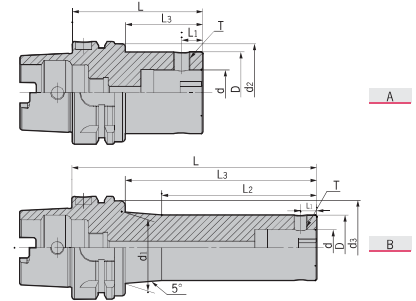
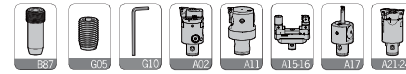

型号 Specification	图示 Figure	D	d	d <sub>1</sub>	d <sub>2</sub>	L <sub>1</sub>	L <sub>2</sub>	L <sub>3</sub>	L	侧固螺钉 Side-lock screw	L型扳手 Wrench	重量 Weight
HSK63A- DCK1-70	A	19	11	-	-	5.05	-	-	70	M050Z050-30P-D	L025	0.72
DCK1-100L	B	19	11	23.5	-	5.05	50	-	100	M050Z050-30P-D	L025	0.80
DCK2-75	A	24	14	-	-	6.45	-	-	75	M050Z060-30P-D	L025	0.77
DCK2-100	A	24	14	-	-	6.45	-	-	100	M050Z060-30P-D	L025	0.86
DCK2-130L	B	24	14	31	-	6.45	65	-	130	M050Z060-30P-D	L025	1.00
DCK3-80	A	31	18	-	-	7.9	-	-	80	M060Z090-30P-D	L03	0.90
DCK3-100	A	31	18	-	-	7.9	-	-	100	M060Z090-30P-D	L03	1.00
DCK3-135L	B	31	18	37	-	7.9	75	-	135	M060Z090-30P-D	L03	1.24
DCK3-165L	B	31	18	41	-	7.9	85	-	165	M060Z090-30P-D	L03	1.48
DCK4-70	A	39	22	-	-	10	-	-	70	M080Z120-30P-D	L04	0.94
DCK4-100	A	39	22	-	-	10	-	-	100	M080Z120-30P-D	L04	1.21
DCK4-150L	B	39	22	44	-	10	95	-	150	M080Z120-30P-D	L04	1.67
DCK4-170L	B	39	22	47.5	-	10	95	-	170	M080Z120-30P-D	L04	1.90
DCK5-80	A	50	28	-	-	13	-	-	80	M100Z160-30P-D	L05	1.26
DCK5-100	A	50	28	-	-	13	-	-	100	M100Z160-30P-D	L05	1.53
DCK5-150	A	50	28	-	-	13	-	-	150	M100Z160-30P-D	L05	2.29
DCK5-180	A	50	28	-	-	13	-	-	180	M100Z160-30P-D	L05	2.74
DCK6-100	A	64	36	-	-	16	-	-	100	M120Z200-30P-D	L06	1.93
DCK6-150	A	64	36	-	-	16	-	-	150	M120Z200-30P-D	L06	3.18
DCK6-180	A	64	36	-	-	16	-	-	180	M120Z200-30P-D	L06	3.89

转下页  
See next page

