

**T**eknik Makina 1987 yılında otomotiv sektöründe imalat hayatına başlamıştır. Bir süre bu sektörde hizmet verdikten sonra 1994'te sektör değiştirerek, kesici takımlar imalatına adım atmıştır. Yaklaşık 5000'i aşkın ürün çeşidi ile geniş bir üretime sahiptir. Kurulduğundan bu güne kadar performans, kalite ve maliyet olarak en iyi ürünlerle hizmet vermeye devam etmektedir.

Kuruluşundan bu yana yüksek teknolojiye, yeniliklere, yeni projelere açık olup kendisini sürekli yenilemektedir.

ini arttırarak ISO9001:2015 belgesini almış; müşterilerinin var olan güvenini daha da pekiştirmiştir. Kısa ve uzun vadeli oluşturulmuş kalkınma plânlarıyla yıllık üretim adetlerini yükseltmeyi hedefleyen TEKNİK MAKİNA konusunda uzman çalışanları ile ilk günkü heyecan ve istekle çalışmalarını sürdürerek dünya ve Türkiye pazarındaki yerini daha da sağlamlaştırarak yükselen grafiğini aynı istikrarda yürütmeye ve ülke ekonomisine katkılarını sürdürmekte kararlıdır.

Ürünlerinin ve hizmetinin kalites-



Technical solution quality

Kalite için TEKNİK Çözüm

*Teknik Cutting tools has been established in 1987 in Turkey. Teknik Cutting Tools started to produce cutting tools in 1994. Over 5.000 kinds of tools are produced in the factory building located in the Fourth Industrial Area of Konya since 2015. Teknik Cutting Tools is a very experienced producer a large range of a Cutting Tools: Face Mills, End Mills, Boring Bars, External Turning Holders and more. There are 40 production lines which are capable to produce in several categories at the same time.*











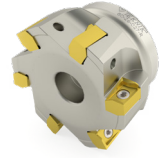

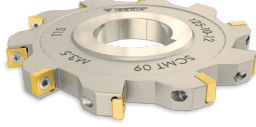
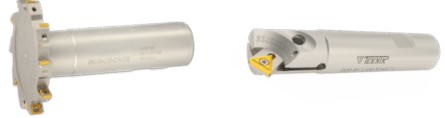
*We keep up to date with new products and when customers need special tools we do all we can to produce the tools to meet their expectations.*







*Production and designing teams are all educated and certified according to the ISO 9001:2015 quality standard to serve you better.*

*The Company Headquarters is also located in Konya.*

*Konya and Istanbul branches are dedicated with marketing and sales. Teknik Cutting Tools does international trade as cutting tools exporter with many countries all around the World and offers the highest level of quality, service and reliability, in a very short lead-time with the best price, guaranteed.*

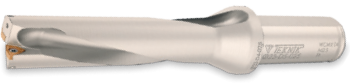

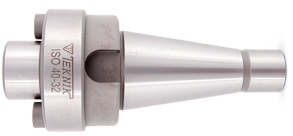
Page	Product Type	
6-23	Tarama Başlığı	
	Face Mill	
	Eckmesserkopf-Rundplattenfräser	
26-30	Baralar	
	Borings Ausdrehwerkzeug	
32-33	Helis Freze - Disk Freze	
	Shoulder Milling - Disc Milling İgelfräser - Scheibenfräser	
36-38	T-Kanal Freze	
	T-Slot Milling Cutter	
	T-Nutenfräser	
40-45	Saplı Tarama - Küre Uçlu Freze	
	End Mill - Radius Cutter - Schaftfräser	
	Küre Uçlu Freze - Radius Cutter - Kugelfräser	
58-61	Vidalı Takım	
	Modular End Mill	
	Einschraubfräser	
64-68	Diş Katerleri	
	Threading Holder Klemhalter (Außengewinde)	
70-73	P Sistem Kater Sogutmalı	
	P System Turning Holder With Coolant	
	P System Drehhalter	
76-77	P Sistem Kater	
	P System Turning Holder	
	P System Drehhalter	
80-85	D Diş Çap Kater	
	D External Turning Holders	
	D System Klemhalter	
88-94	S Sistem Diş Çap Kater	
	S System External Turning Holders	
	S System ystem Klemhalter	
96-99	P Sistem İç Çap Kater	
	P System Boring Bars P System Bohrstange	
102-105	D Sistem İç Çap Kater	
	D System Boring Bars	
	D System Bohrstange	

Page	Product Type	
108-115	S Sistem İç Çap Kater	
	S System Boring Bars	
	S System Bohrstange	
118-120	Karbür Takımlar ve Setler	
	VHM Bohrstange / Set	
122-123	İç Çap Kater Set	
	Boring Bars Set	
	Bohrstangen Set	
126-135	U-Drill	
	Indexable Insert Drills	
	Vollbohrer	
138-144	Kanal Kater - Keski Kütüğü	
	Grooving Holders - Block For Blades	
	Stech-Klemmhalter - Grundhalter für Absteichschwer	
146-148	İç Çap Kanal Kater	
	Grooving Holders Mini Tool	
	Stech-Klemmhalter	
148	Takım Tutucuları	
	Tool Holders	
	Werkzeugaufnahmen	
152-155	Yedek Parça	
	Spare Parts	
	Zubehör	
156-157	Kesme Verileri - ISO Kodları	
	Cutting Data- ISO Code	
	Schnittdaten - ISO Code	

# Kalite için TEKNİK Çözüm

Technical solution for quality



Face Milling  
Chamfer End Mills



[www.teknikcuttingtools.com](http://www.teknikcuttingtools.com)



Kalite için TEKNİK çözüm  
Technical solution for quality

6-24



### 45° SNKX 1206

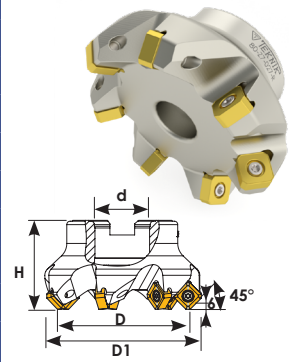

Order Code	Product Code	Dimensions (mm)						Insert	Price
		D	D1	d	Z	H			
T319	D040 d16 Z03 SNKX 12	40	53	16	3	45	0,417		56 €
T320	D050 d22 Z04 SNKX 12	50	63	22	4	44	0,593		59 €
T322	D063 d22 Z06 SNKX 12	63	76	22	6	44	0,710	SNKX 1206	79 €
T325	D080 d27 Z07 SNKX 12	80	93	27	7	52	1,334		92 €
T330	D100 d32 Z08 SNKX 12	100	113	32	8	52	1,926		120 €
T332	D125 d40 Z10 SNKX 12	125	138	40	10	63	3,780		162 €
T334	D160 d40 Z12 SNKX 12	160	173	40	12	63	5,380		198 €
T335	D200 d60 Z14 SNKX 12	200	213	60	14	63	6,690		282 €

Compatible with KRLY-PLBT-BHLR insert. / Kompatibel für KRLY-PLBT-BHLR WP

### 45° SNMU 1305

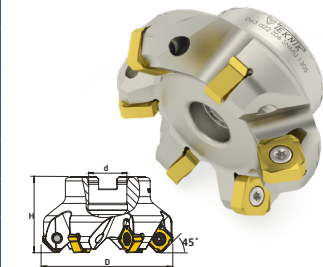

Order Code	Product Code	Dimensions (mm)					Insert	Price	
		D	d	Z	H				
T234	D050 d22 Z04 SNMU 13	50	22	4	44	0,480		59 €	
T235	D063 d22 Z06 SNMU 13	63	22	6	44	0,645	SNMU 1305	79 €	
T236	D080 d27 Z07 SNMU 13	80	27	7	52	1,147	ISCR	92 €	
T237	D100 d32 Z08 SNMU 13	100	32	8	52	1,487		120 €	
T238	D125 d40 Z10 SNMU 13	125	40	10	63	3,610		162 €	

Compatible with ISCR insert. / Kompatibel für ISCR WP

### 45° SNEU 1206

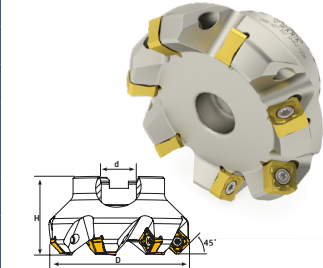

Order Code	Product Code	Dimensions (mm)					Insert	Price	
		D	d	Z	H				
T164	D050 d22 Z05 SNEU 12	50	22	5	40	0,447		69 €	
T165	D063 d22 Z06 SNEU 12	63	22	6	40	0,582	SNEU 1206	79 €	
T166	D080 d27 Z07 SNEU 12	80	27	7	50	1,252		92 €	
T167	D100 d32 Z08 SNEU 12	100	32	8	50	1,925		120 €	
T168	D125 d40 Z10 SNEU 12	125	40	10	63	3,516		162 €	

Compatible with XTC-GSC-WLTR insert. / Kompatibel für XTC-GSC-WLTR WP

### 45° SNKX 1206-ONHX 0505

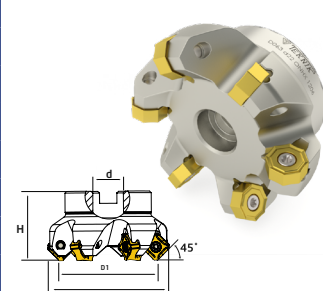

Order Code	Product Code	Dimensions (mm)						Insert	Price
		D	D1	d	Z	H			
T623	D050 d22 Z04 SNKX 12 ONHX 05	50	42,4	22	4	40	0,458		59 €
T624	D063 d22 Z06 SNKX 12 ONHX 05	63	55,4	22	6	40	0,608	SNKX 1206	79 €
T625	D080 d27 Z07 SNKX 12 ONHX 05	80	72,4	27	7	50	1,051	ONHX 0505	92 €
T626	D100 d32 Z08 SNKX 12 ONHX 05	100	92,4	32	8	50	1,813	PLBT	120 €
T627	D125 d40 Z10 SNKX 12 ONHX 05	125	117,4	40	10	63	3,277		162 €
T628	D160 d40 Z12 SNKX 12 ONHX 05	160	152,4	40	12	63	4,577		198 €



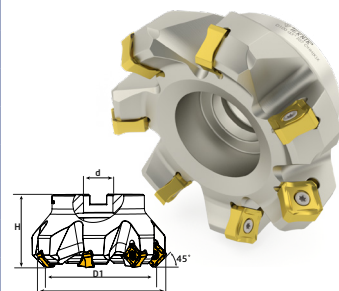

Compatible with PLBT insert. / Kompatibel für PLBT WP



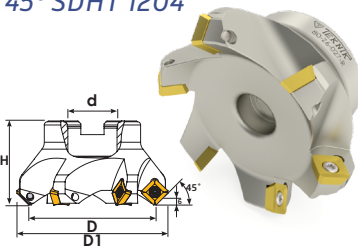

### 45° SNKX 1606-ONHX 0606





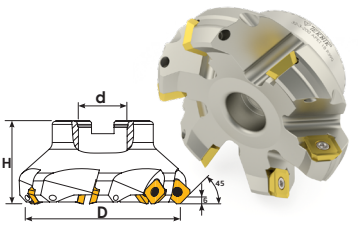



Order Code	Product Code	Dimensions (mm)						Insert	Price
		D	D1	d	Z	H			
T629	D063 d22 Z05 SNKX 16 ONHX 06	63	63	22	5	50	0,776		79 €
T630	D080 d27 Z06 SNKX 16 ONHX 06	80	80	27	6	50	2,013	SNKX 1606	92 €
T631	D100 d32 Z07 SNKX 16 ONHX 06	100	100	32	7	63	2,750	ONHX 0606	107 €
T632	D125 d40 Z08 SNKX 16 ONHX 06	125	125	40	8	63	4,026	PLBT	162 €
T633	D160 d40 Z10 SNKX 16 ONHX 06	160	160	40	10	63	4,712		198 €
T634	D200 d60 Z12 SNKX 16 ONHX 06	200	200	60	12	63	8,112		282 €

Compatible with PLBT insert. / Kompatibel für PLBT WP

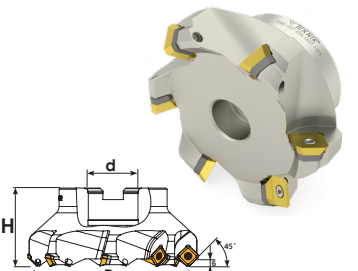



45° SDHT 1204	Order Code	Product Code	Dimensions (mm)					Insert	Price	
			D	D1	d	Z	H			
	T300	D063 d22 Z05 SDHT 12	63	77	22	5	45	0,630		74 €
	T302	D080 d27 Z06 SDHT 12	80	94	27	6	52	1,200	SDHT 1204	87 €
	T304	D100 d32 Z07 SDHT 12	100	114	32	7	62	2,040	ISO	105 €
	T305	D125 d40 Z08 SDHT 12	125	139	40	8	62	4,095		136 €
		 TC080 M4,5x11						 T15		

45° SEET 12T3 R245	Order Code	Product Code	Dimensions (mm)					Insert	Price	
			D	d	Z	H				
	T435	D063 d22 Z05 SEET 12	63	22	5	50	0,815		74 €	
	T436	D080 d27 Z06 SEET 12	80	27	6	52	1,305	SEET 12T3	87 €	
	T437	D100 d32 Z07 SEET 12	100	32	7	55	1,715	R245	105 €	
	T438	D125 d40 Z08 SEET 12	125	40	8	62	3,427		136 €	
		 TC067 M3,5x8,5						 T15		



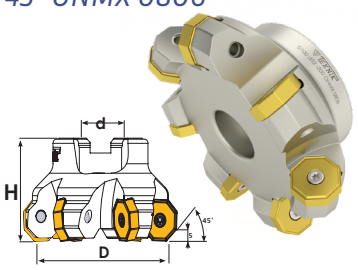

Compatible with ZCC -SNDVK-XTC insert. / Kompatibel für ZCC -SNDVK-XTC WP

45° SEET 12T3 R245	Order Code	Product Code	Dimensions (mm)					Insert	Price		
			D	d	Z	H					
	T560	D050 d22 Z04 SEET 12	50	22	4	40	0,345		91 €		
	T562	D063 d22 Z05 SEET 12	63	22	5	40	0,505	SEET 12T3	113 €		
	T564	D080 d27 Z06 SEET 12	80	27	6	50	1,206	R245	130 €		
	T566	D100 d32 Z07 SEET 12	100	32	7	50	1,812		157 €		
	T568	D125 d40 Z08 SEET 12	125	40	8	63	3,390		194 €		
	T570	D160 d40 Z10 SEET 12	160	40	10	63	4,590		252 €		
		 TC068 M3,5x11						 TA052	 TC049 M5x7	 T15	

Compatible with ZCC -SNDVK-XTC insert. / Kompatibel für ZCC -SNDVK-XTC WP

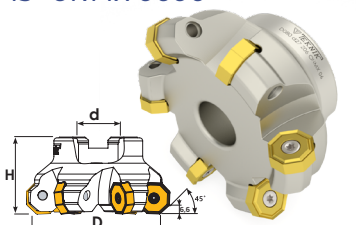
45° ONMX 0806	Order Code	Product Code	Dimensions (mm)					Insert	Price	
			D	d	Z	H				
	T780	D063 d22 Z05 ONMX 08	63	22	5	40	1,063	ONMX 0806 KRL	79 €	
	T782	D080 d27 Z06 ONMX 08	80	27	6	50	0,532	ONMX 0806 ISCR	92 €	
	T784	D100 d32 Z07 ONMX 08	100	32	7	50	1,067	ONMU 0806 YG1	107 €	
	T786	D125 d40 Z08 ONMX 08	125	40	8	63	3,574	ONKX 0806 LMN	162 €	
		 TC083 M5x12						 T20		

Compatible with KRLY-ISCR-YG1-LMN insert. / Kompatibel für KRLY-ISCR-YG1-LMN WP

45° ONMX 0606	Order Code	Product Code	Dimensions (mm)					Insert	Price	
			D	d	Z	H				
	T790	D063 d22 Z05 ONMX 06	63	22	5	45	0,657		79 €	
	T791	D080 d27 Z06 ONMX 06	80	27	6	50	1,110	ONMX 0606	92 €	
	T792	D100 d32 Z07 ONMX 06	100	32	7	52	1,701	KRLY	107 €	
		 TC083 M5x12						 T20		

Compatible with KRLY insert. / Kompatibel für KRLY WP

### 55° HNHX 1006

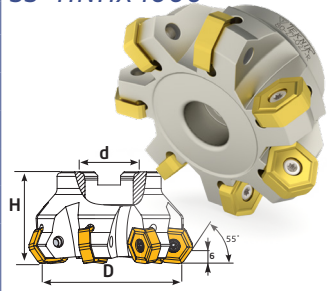

Order Code	Product Code	Dimensions (mm)					Insert	Price
		D	d	Z	H			
T470	D063 d22 Z05 HNHX 10	63	22	5	50	0,675		79 €
T472	D080 d27 Z07 HNHX 10	80	27	7	50	1,063	HNHX 1006	92 €
T474	D100 d32 Z09 HNHX 10	100	32	9	62	2,023	TGTC	124 €
T476	D125 d40 Z10 HNHX 10	125	40	10	62	3,331		162 €
T478	D160 d40 Z12 HNHX 10	160	40	12	62	4,724		198 €

Compatible with TGTC insert. / Kompatibel für TGTC WP

### PNMU 1206

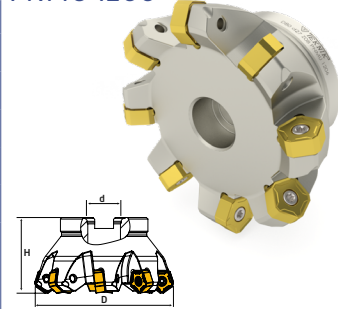

Order Code	Product Code	Dimensions (mm)					Insert	Price
		D	d	Z	H			
T722	D050 d22 Z04 PNMU 12	50	22	4	40	0,371		59 €
T723	D063 d22 Z05 PNMU 12	63	22	5	40	0,594	PNMU 1206	69 €
T724	D080 d27 Z08 PNMU 12	80	27	8	50	1,273	YG1	79 €
T725	D100 d32 Z10 PNMU 12	100	32	10	50	1,901		150 €
T726	D125 d40 Z10 PNMU 12	125	40	10	63	4,070		158 €

Compatible with YG1 insert. / Kompatibel für YG1 WP

### 45° ONMU 0505

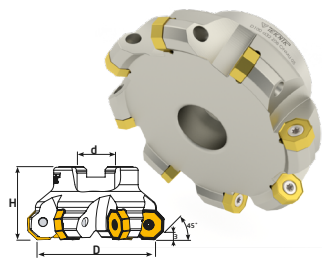

Order Code	Product Code	Dimensions (mm)					Insert	Price
		D	d	Z	H			
T794	D063 d22 Z06 ONMU 05	63	22	6	45	0,652		79 €
T796	D080 d27 Z07 ONMU 05	80	27	7	50	1,202	ONMU 0505	92 €
T798	D100 d32 Z08 ONMU 05	100	32	8	52	1,842	ISCR	120 €
T800	D125 d40 Z10 ONMU 05	125	40	10	62	3,537		162 €
T801	D160 d40 Z12 ONMU 05	160	40	12	62	4,863		198 €

Compatible with ISCR insert. / Kompatibel für ISCR WP

### 55° HNGX 0906

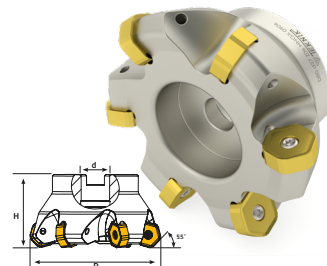

Order Code	Product Code	Dimensions (mm)					Insert	Price
		D	d	Z	H			
T418	D063 d22 Z06 HNGX 09	63	22	6	40	0,518		79 €
T419	D080 d27 Z06 HNGX 09	80	27	6	50	1,067	HNGX 0906	92 €
T420	D100 d32 Z08 HNGX 09	100	32	8	50	1,542	PRMT	120 €
T421	D125 d40 Z08 HNGX 09	125	40	8	63	3,314		162 €
T422	D160 d40 Z12 HNGX 09	160	40	12	63	3,962		198 €

Compatible with PRMT insert. / Kompatibel für PRMT WP

### 43° ODHT 0605

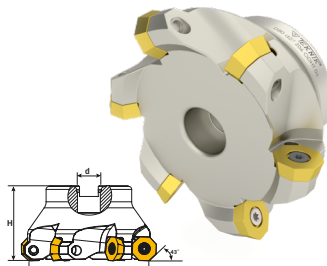

Order Code	Product Code	Dimensions (mm)					Insert	Price
		D	d	Z	H			
T210	D063 d22 Z05 ODHT 06	63	22	5	40	0,610		74 €
T211	D080 d27 Z06 ODHT 06	80	27	6	50	1,070	ODHT 0605	92 €
T212	D100 d32 Z07 ODHT 06	100	32	7	52	1,765	WLTR	100 €
T213	D125 d40 Z08 ODHT 06	125	40	8	62	3,528		136 €

Compatible with WLTR insert. / Kompatibel für WLTR WP



**43° OFCR 0704**

Order Code	Product Code	Dimensions (mm)					Insert	Price
		D	d	Z	H			
T260	D050 d22 Z04 OFCR 07	50	22	4	45	0,488		59 €
T262	D063 d22 Z04 OFCR 07	63	22	4	45	0,722	OFCR 0704	79 €
T264	D080 d27 Z06 OFCR 07	80	27	6	50	1,205	ISO	92 €
T266	D100 d32 Z08 OFCR 07	100	32	8	50	1,654		120 €
T268	D125 d40 Z09 OFCR 07	125	40	9	62	3,510		134 €
T269	D160 d40 Z12 OFCR 07	160	40	12	62	5,112		198 €

BK300    
 TC300 M8x18    
 4 Allen    

**90° XNEX 0806**

Order Code	Product Code	Dimensions (mm)					Insert	Price
		D	d	Z	H			
T840	D050 d22 Z04 XNEX 08	50	22	4	45	0,400		59 €
T841	D050 d22 Z05 XNEX 08	50	22	5	45	0,394		69 €
T842	D063 d22 Z06 XNEX 08	63	22	6	45	0,490	XNEX 0806 SCO	79 €
T844	D080 d27 Z07 XNEX 08	80	27	7	50	1,063	XNEX 0806 SCO	92 €
T846	D100 d32 Z07 XNEX 08	100	32	7	52	1,755	XNEX 0806 SCO	107 €
T848	D125 d40 Z10 XNEX 08	125	40	10	60	3,155	XNEX 0806 SCO	162 €
T850	D160 d40 Z12 XNEX 08	160	40	12	63	5,154	XNEX 0806 SCO	198 €
T851	D200 d60 Z14 XNEX 08	200	60	14	63	6,415	XNEX 0806 SCO	282 €

TC076 M4x12,5    
 T15    

Compatible with SCO-WNST insert. / Kompatibel für SCO-WNST WP

**90° WNGX 0806**

Order Code	Product Code	Dimensions (mm)					Insert	Price
		D	d	Z	H			
T775	D050 d22 Z05 WNGX 08	50	22	5	40	0,277		69 €
T776	D063 d22 Z06 WNGX 08	63	22	6	40	0,470	WNGX 0806	79 €
T777	D080 d27 Z07 WNGX 08	80	27	7	50	1,105	KRLY	92 €
T778	D100 d32 Z08 WNGX 08	100	32	8	52	1,580		120 €

TC083 M5x12    
 T20    

Compatible with KRLY insert. / Kompatibel für KRLY WP

**90° WNGX 0403**

Order Code	Product Code	Dimensions (mm)					Insert	Price
		D	d	Z	H			
T692	D040 d16 Z06 WNGX 04	40	16	6	40	0,256		76 €
T693	D050 d22 Z08 WNGX 04	50	22	8	40	0,347	WNGX 0403	108 €
T694	D063 d22 Z10 WNGX 04	63	22	10	40	0,617	KRLY	162 €
T695	D080 d27 Z11 WNGX 04	80	27	11	50	1,306		149 €

TC060 M2,5x5,5    
 T8    

Compatible with KRLY insert. / Kompatibel für KRLY WP

**90° WNMU 0705**

Order Code	Product Code	Dimensions (mm)					Insert	Price
		D	d	Z	H			
T392	D050 d22 Z05 WNMU 07	50	22	5	40	0,337		69 €
T393	D063 d22 Z06 WNMU 07	63	22	6	40	0,515	WNMU 0705	79 €
T394	D080 d27 Z07 WNMU 07	80	27	7	50	1,012	ISC	92 €
T395	D100 d32 Z08 WNMU 07	100	32	8	50	1,342		114 €

TC074 M4x10    
 T15    

Compatible with ISCR insert. / Kompatibel für ISCR WP

### 90° WNMU 0806

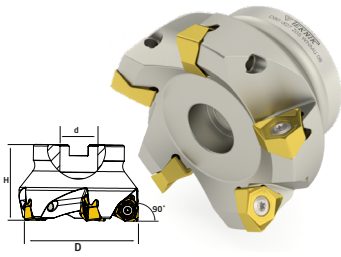

Order Code	Product Code	Dimensions (mm)					Insert	Price
		D	d	Z	H	kg		
T543	D050 d22 Z03 WNMU 08	50	22	3	46	0,360		59 €
T544	D063 d22 Z04 WNMU 08	63	22	4	46	0,556	WNMU 0806	79 €
T545	D080 d27 Z05 WNMU 08	80	27	5	50	1,016	KYCRA	92 €
T546	D100 d32 Z06 WNMU 08	100	32	6	50	1,360		120 €
		TC083 M5x12		T20				

Compatible with KYCRA insert. / Kompatibel für KYCRA WP

### 88° SNMX 1206

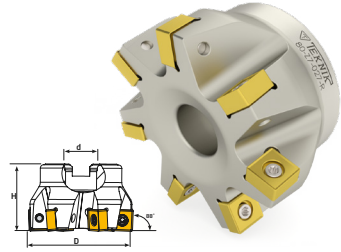

Order Code	Product Code	Dimensions (mm)					Insert	Price
		D	d	Z	H	kg		
T344	D063 d22 Z06 SNMX 12	63	22	6	40	0,574		79 €
T345	D080 d27 Z07 SNMX 12	80	27	7	50	1,213	SNMX 1206	92 €
T346	D100 d32 Z08 SNMX 12	100	32	8	50	1,688	KRLY	120 €
		TC076 M4x12,5		T15				

Compatible with KRLY insert. / Kompatibel für KRLY WP

### 88° SNHU 1206

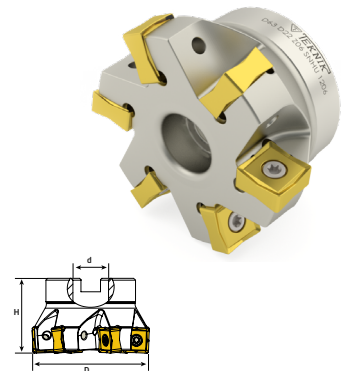

Order Code	Product Code	Dimensions (mm)					Insert	Price
		D	d	Z	H	kg		
T616	D050 d22 Z04 SNHU 12	50	22	4	40	0,298		59 €
T617	D050 d22 Z05 SNHU 12	50	22	5	40	0,305		69 €
T617-1	D063 d22 Z05 SNHU 12	63	22	5	40	0,472	SNHU 1206	74 €
T618	D063 d22 Z06 SNHU 12	63	22	6	40	0,503	PLBT	79 €
T618-1	D080 d27 Z06 SNHU 12	80	27	6	50	0,968		86 €
T619	D080 d27 Z07 SNHU 12	80	27	7	50	1,076		92 €
T620	D100 d32 Z08 SNHU 12	100	32	8	50	1,459		120 €
T621	D125 d40 Z10 SNHU 12	125	40	10	63	2,708		162 €
T622	D160 d40 Z12 SNHU 12	160	40	12	63	4,328		198 €
		TC074 M4x10		T15				

Compatible with PLBT insert. / Kompatibel für PLBT WP

### 90° SPMT 1204

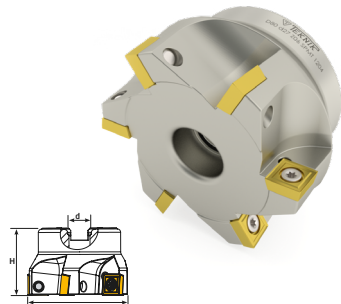

Order Code	Product Code	Dimensions (mm)					Insert	Price
		D	d	Z	H	kg		
T649	D040 d16 Z03 SPMT 12	40	16	3	40	0,253		56 €
T650	D050 d22 Z04 SPMT 12	50	22	4	40	0,362		59 €
T651	D063 d22 Z05 SPMT 12	63	22	5	50	0,772		74 €
T652	D080 d27 Z06 SPMT 12	80	27	6	50	1,186	SPMT 1204	87 €
T653	D100 d32 Z08 SPMT 12	100	32	8	50	1,786		120 €
T654	D125 d40 Z08 SPMT 12	125	40	8	63	2,935		162 €
T655	D160 d40 Z10 SPMT 12	160	40	10	63	3,980		187 €
		TC083 M5x12		T20				



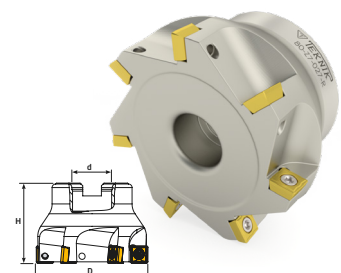

Compatible with PLBT-ZCC-WLTR insert. / Kompatibel für PLBT-ZCC-WLTR WP

### 90° SPMG 0904



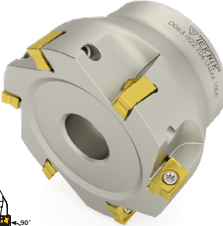
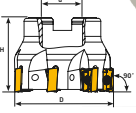



Order Code	Product Code	Dimensions (mm)					Insert	Price
		D	d	Z	H	kg		
T338	D050 d22 Z05 SPMG 09	50	22	5	45	0,239	SPMG 0904	69 €
T340	D063 d22 Z06 SPMG 09	63	22	6	45	0,362	TGTC	79 €
T342	D080 d27 Z07 SPMG 09	80	27	7	52	1,088		92 €
		TC067 M3,5x8,5		T15				



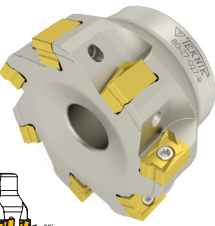
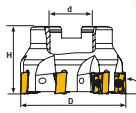



Compatible with TGTC insert. / Kompatibel für TGTC WP

90° LNMX 1006	Order Code	Product Code	Dimensions (mm)					Insert	Price
			D	d	Z	H			
	T386	D040 d16 Z05 LNMX 10	40	16	5	40	0,258		69 €
	T387	D050 d22 Z06 LNMX 10	50	22	6	45	0,472	LNMX 1006	77 €
	T388	D063 d22 Z06 LNMX 10	63	22	6	45	0,495	KRLY	79 €
	T389	D080 d27 Z07 LNMX 10	80	27	7	50	0,731		92 €
	T390	D100 d32 Z09 LNMX 10	100	32	9	50	1,700		119 €
					TC065 M3x7			T8	



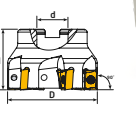

Compatible with KRLY insert. / Kompatibel für KRLY WP

90° LNMX 1510	Order Code	Product Code	Dimensions (mm)					Insert	Price
			D	d	Z	H			
	T372	D050 d22 Z04 LNMX 15	50	22	4	45	0,375		59 €
	T374	D063 d22 Z06 LNMX 15	63	22	6	45	0,616		79 €
	T376	D080 d27 Z07 LNMX 15	80	27	7	50	1,087	LNMX 1510	92 €
	T378	D100 d32 Z08 LNMX 15	100	32	8	52	1,644	KRLY	120 €
	T380	D125 d40 Z10 LNMX 15	125	40	10	63	3,650		162 €
					TC076 M4x12,5			T15	



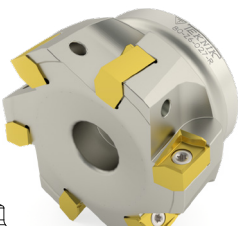
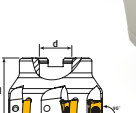

Compatible with KRLY insert. Kompatibel für KRLY WP

90° ANKX 1205	Order Code	Product Code	Dimensions (mm)					Insert	Price
			D	d	Z	H			
	T571	D040 d16 Z04 ANKX 12	40	16	4	40	0,215		59 €
	T572	D050 d22 Z05 ANKX 12	50	22	5	45	0,433	ANKX 1205	69 €
	T574	D063 d22 Z06 ANKX 12	63	22	6	45	0,596	ISCR	79 €
	T576	D080 d27 Z07 ANKX 12	80	27	7	50	1,210		92 €
					TC074 M4x10			T15	

Compatible with ISCR insert. / Kompatibel für ISCR WP

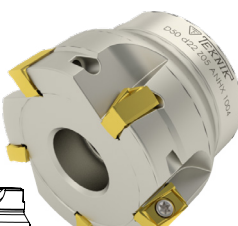
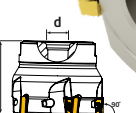
90° ANKX 1706	Order Code	Product Code	Dimensions (mm)					Insert	Price
			D	d	Z	H			
	T440	D040 d16 Z03 ANKX 17	40	16	3	45	0,279		56 €
	T442	D050 d22 Z04 ANKX 17	50	22	4	45	0,371	ANKX 1706	59 €
	T444	D063 d22 Z05 ANKX 17	63	22	5	45	0,573	ISCR	79 €
	T446	D080 d27 Z06 ANKX 17	80	27	6	52	1,238		92 €
	T448	D100 d32 Z07 ANKX 17	100	32	7	52	2,029		107 €
	T450	D125 d40 Z08 ANKX 17	125	40	8	63	3,590		113 €
					TC083 M5x12			T20	

Compatible with ISCR insert. / Kompatibel für ISCR WP

90° ANHX 1004	Order Code	Product Code	Dimensions (mm)					Insert	Price
			D	d	Z	H			
	T656	D040 d16 Z04 ANHX 10	40	16	4	40	0,250		59 €
	T657	D050 d22 Z05 ANHX 10	50	22	5	40	0,374	ANHX 1004	69 €
	T658	D063 d22 Z07 ANHX 10	63	22	7	40	0,638	PLBT	92 €
	T659	D080 d27 Z08 ANHX 10	80	27	8	50	1,132		103 €
					TC065 M3x7			T8	

Compatible with PLBT insert. / Kompatibel für PLBT WP

### 90° ANHX 1206

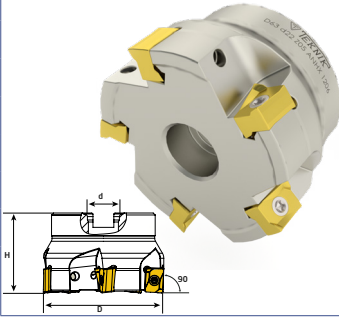

Order Code	Product Code	Dimensions (mm)					Insert	Price
		D	d	Z	H	kg		
T641	D040 d16 Z04 ANHX 12	40	16	4	40	0,248		59 €
T642	D050 d22 Z05 ANHX 12	50	22	5	40	0,375		79 €
T643	D063 d22 Z05 ANHX 12	63	27	5	40	0,619	ANHX 1206	84 €
T644	D080 d27 Z08 ANHX 12	80	27	8	50	1,209	PLBT	120 €
T645	D100 d32 Z12 ANHX 12	100	32	12	50	1,761		176 €
T646	D125 d40 Z14 ANHX 12	125	40	14	63	3,091		282 €
		TC069 M3,5x8,5		T10				

Compatible with PLBT insert. / Kompatibel für PLBT WP

### 90° ANKX 1607

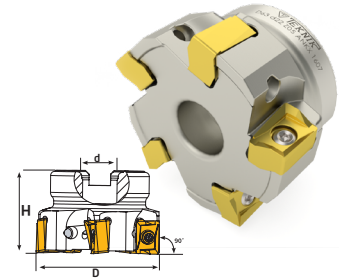

Order Code	Product Code	Dimensions (mm)					Insert	Price
		D	d	Z	H	kg		
T171	D050 d22 Z04 ANKX 16	50	22	4	40	0,307		59 €
T172	D063 d22 Z05 ANKX 16	63	22	5	40	0,462	ANKX 1607	79 €
T173	D080 d27 Z06 ANKX 16	80	27	6	50	1,101		92 €
		TC080-1 M4,5x11		T15				

Compatible with XTC- GSC insert. / Kompatibel für XTC- GSC WP

### 90° LNGX 1307

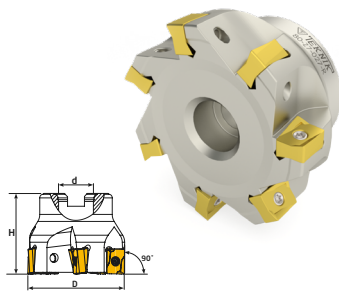

Order Code	Product Code	Dimensions (mm)					Insert	Price
		D	d	Z	H	kg		
T488	D040 d16 Z03 LNGX 13	40	16	3	45	0,304		56 €
T490	D050 d22 Z04 LNGX 13	50	22	4	45	0,425		59 €
T492	D063 d22 Z06 LNGX 13	63	22	6	45	0,560	LNGX 1307	79 €
T493	D080 d27 Z07 LNGX 13	80	27	7	50	1,124	WLTR	92 €
T494	D100 d32 Z07 LNGX 13	100	32	7	50	1,542		107 €
T495	D125 d40 Z08 LNGX 13	125	40	8	63	3,555		113 €
		TC079 M4x10		T15				

Compatible with WLTR insert. / Kompatibel für WLTR WP

### 90° LNGU 15T6

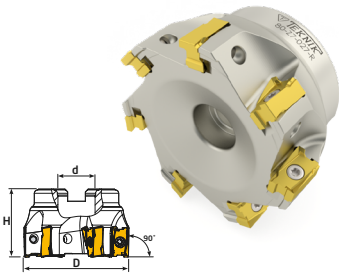

Order Code	Product Code	Dimensions (mm)					Insert	Price
		D	d	Z	H	kg		
T956	D050 d22 Z05 LNGU 15	50	22	5	40	0,305		69 €
T958	D063 d22 Z06 LNGU 15	63	22	6	40	0,541	LNGU 15T6	79 €
T960	D080 d27 Z07 LNGU 15	80	27	7	50	1,133	KNNMTL	92 €
T961	D100 d32 Z08 LNGU 15	100	32	8	50	1,933		120 €
		TC074 M4x10		T15				

Compatible with KNNMTL insert. / Kompatibel für KNNMTL WP

### 90° LNHU 1306

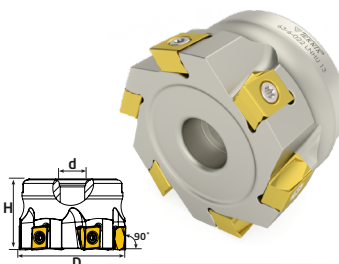

Order Code	Product Code	Dimensions (mm)					Insert	Price
		D	d	Z	H	kg		
T580	D050 d22 Z05 LNHU 13	50	22	5	40	0,350		69 €
T581	D063 d22 Z06 LNHU 13	63	22	6	40	0,628	LNHU 1306	79 €
T582	D080 d27 Z07 LNHU 13	80	27	7	50	1,315	WLTR	92 €
T583	D100 d32 Z08 LNHU 13	100	32	8	50	1,795		103 €
		TC079 M4x10		T15				

Compatible with WLTR insert. / Kompatibel für WLTR WP

**90° LNMT 1306**

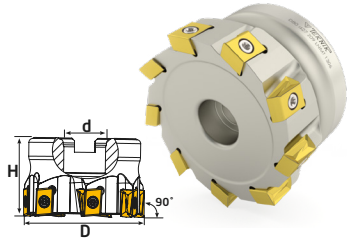

Order Code	Product Code	Dimensions (mm)					Insert	Price
		D	d	Z	H	kg		
T228	D050 d22 Z05 LNMT 13	50	22	5	40	0,337		68 €
T229	D063 d22 Z06 LNMT 13	63	22	6	40	0,596	LNMT 1306	91 €
T230	D080 d27 Z07 LNMT 13	80	27	7	50	1,227	ISCR	117 €
T231	D100 d32 Z08 LNMT 13	100	32	8	50	1,682		127 €
T232	D125 d40 Z09 LNMT 13	125	40	9	63	3,325		148 €
T233	D160 d40 Z12 LNMT 13	160	40	12	63	5,046		194 €
		TC 074 M4x10		T15				

Compatible with ISCR insert. / Kompatibel für ISCR WP

**90° LNMT 0804**

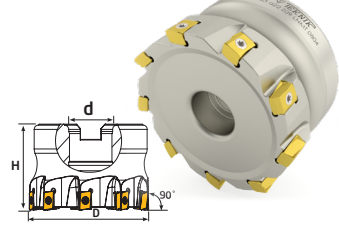

Order Code	Product Code	Dimensions (mm)					Insert	Price
		D	d	Z	H	kg		
T222	D040 d16 Z06 LNMT 08	40	16	6	40	0,240		76 €
T223	D050 d22 Z07 LNMT 08	50	22	7	40	0,374	LNMT 0804	89 €
T224	D063 d22 Z09 LNMT 08	63	22	9	40	0,665	ISCR	100 €
T225	D080 d27 Z10 LNMT 08	80	27	10	50	1,145		124 €
		TC061 M2,5x6,5		T8				

Compatible with ISCR insert. / Kompatibel für ISCR WP

**90° LNXT 1306**

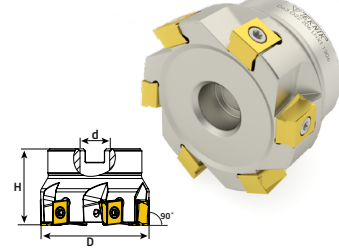

Order Code	Product Code	Dimensions (mm)					Insert	Price
		D	d	Z	H	kg		
T672	D040 d16 Z04 LNXT 13	40	16	4	40	0,225		53 €
T673	D050 d22 Z05 LNXT 13	50	22	5	40	0,358	LNXT 1306	68 €
T674	D063 d22 Z06 LNXT 13	63	22	6	40	0,604	PLBT	78 €
T675	D080 d27 Z07 LNXT 13	80	27	7	50	1,029		91 €
T676	D100 d32 Z08 LNXT 13	100	32	8	50	1,733		112 €
		TC074 M4x10		T15				

Compatible with PLBT insert. / Kompatibel für PLBT WP

**90° LOEX 1207**

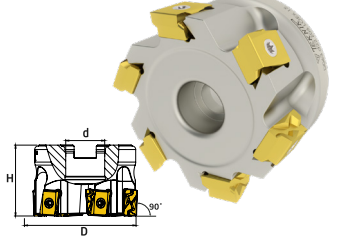

Order Code	Product Code	Dimensions (mm)					Insert	Price
		D	d	Z	H	kg		
T586	D050 d22 Z05 LOEX12	50	22	5	40	0,358	LOEX 1207	68 €
T587	D063 d22 Z06 LOEX12	63	22	6	40	0,604	SCO	78 €
T588	D080 d27 Z07 LOEX12	80	27	7	50	1,029		91 €
		TC074 M4x10		T15				

Compatible with SCO insert. / Kompatibel für SCO WP

**90° XNKT 0805**

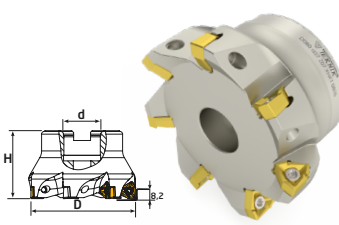

Order Code	Product Code	Dimensions (mm)					Insert	Price
		D	d	Z	H	kg		
T900	D040 d16 Z04 XNKT 08	40	16	4	45	0,296		58 €
T902	D050 d22 Z05 XNKT 08	50	22	5	45	0,396	XNKT 0805	68 €
T904	D063 d22 Z06 XNKT 08	63	22	6	45	0,575	KRLY	78 €
T906	D080 d27 Z07 XNKT 08	80	27	7	50	1,015		91 €
T907	D100 d40 Z08 XNKT 08	100	40	8	52	1,575		118 €
		TC072 M4x10		T15				

Compatible with KRLY insert. / Kompatibel für KRLY WP

**90° XNKT 0604**

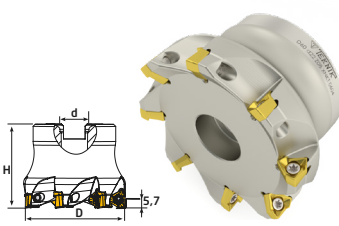

Order Code	Product Code	Dimensions (mm)					Insert	Price
		D	d	Z	H	kg		
T852	D032 d16 Z04 XNKT 06	32	16	4	40	0,150		58 €
T853	D040 d16 Z06 XNKT 06	40	16	6	40	0,219	XNKT 0604	78 €
T854	D050 d22 Z07 XNKT 06	50	22	7	40	0,348	KRLY	85 €
T855	D063 d22 Z08 XNKT 06	63	22	8	40	0,527		103 €
T856	D080 d27 Z10 XNKT 06	80	27	10	50	0,938		127 €
		TC065-1M3x7		T8				

Compatible with KRLY insert. / Kompatibel für KRLY WP

### 90° 3PKT 1505

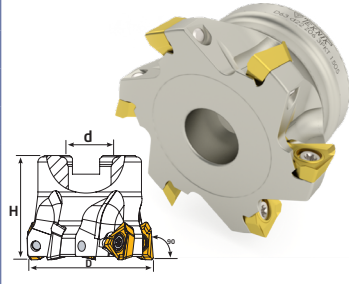

Order Code	Product Code	Dimensions (mm)					Insert	Price
		D	d	Z	H	kg		
T398	D050 d22 Z05 3PKT 15	50	22	5	40	0,325		69 €
T399	D063 d22 Z06 3PKT 15	63	22	6	40	0,490	3PKT 1505	79 €
T400	D080 d27 Z07 3PKT 15	80	27	7	50	1,105	TGTC	92 €
		TC074 M4x10		T15				

Compatible with TGTC insert. / Kompatible für TGTC WP

### WNMX 09T3

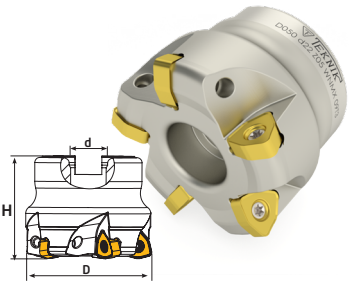

Order Code	Product Code	Dimensions (mm)					Insert	Price
		D	d	Z	H	kg		
T669	D040 d16 Z04 WNMX 09	40	16	4	40	0,213		59 €
T670	D050 d22 Z05 WNMX 09	50	22	5	40	0,329	WNMX 09T3	69 €
T671	D063 d22 Z06 WNMX 09	63	22	6	40	0,542	KRLY	79 €
T671-1	D080 d27 Z06 WNMX 09	80	27	6	50	1,077		84 €
T671-2	D100 d32 Z07 WNMX 09	100	32	7	50	1,627		98 €
		TC065 M3x7		T8				

Compatible with KRLY insert. / Kompatible für KRLY WP

### WNMX 1305

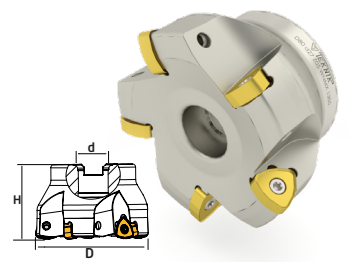

Order Code	Product Code	Dimensions (mm)					Insert	Price
		D	d	Z	H	kg		
T687	D063 d22 Z04 WNMX 13	63	22	4	50	0,752		59 €
T688	D080 d27 Z05 WNMX 13	80	27	5	50	1,040	WNMX 1305	81 €
T689	D100 d32 Z06 WNMX 13	100	32	6	50	1,625	KRLY	120 €
T690	D125 d40 Z07 WNMX 13	125	40	7	63	3,716		142 €
		TC074 M4x10		T15				

Compatible with KRLY insert. / Kompatible für KRLY WP

### 100° BLMP 0603

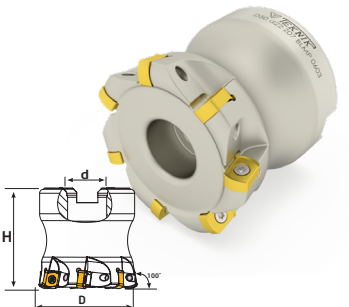

Order Code	Product Code	Dimensions (mm)					Insert	Price
		D	d	Z	H	kg		
T480	D040 d16 Z06 BLMP 06	40	16	6	45	0,262	BLMP 0603	79 €
T481	D050 d22 Z07 BLMP 06	50	22	7	50	0,457	TGTC	92 €
T482	D052 d22 Z07 BLMP 06	52	22	7	50	0,472		92 €
		TC064 M3x6,5		T8				

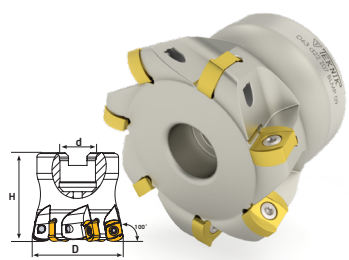

Compatible with TGTC insert. / Kompatible für TGTC WP

### 100° BLMP 0904





Order Code	Product Code	Dimensions (mm)					Insert	Price
		D	d	Z	H	kg		
T485	D040 d16 Z05 BLMP 09	40	16	5	40	0,176		66 €
T486	D052 d22 Z06 BLMP 09	52	22	6	50	0,427	BLMP 0904	79 €
T487	D063 d22 Z07 BLMP 09	63	22	7	50	0,615	TGTC	92 €
		TC069 M3,5x8,5		T10				



Compatible with TGTC insert. / Kompatible für TGTC WP

Order Code	Product Code	Dimensions (mm)					Insert	Price
		D	d	Z	H	kg		
T835	D032 d16 Z05 LNMX 06	32	16	5	40	0,173	LNMX 0603	66 €
T836	D040 d16 Z06 LNMX 06	40	16	6	40	0,279	KRLY	79 €
T837	D050 d22 Z08 LNMX 06	50	22	8	40	0,400		95 €
		 TC065-1 M3x7		 T8				



Compatible with KRLY insert. / Kompatibel für KRLY WP

Order Code	Product Code	Dimensions (mm)					Insert	Price
		D	d	Z	H	kg		
T763	D040 d16 Z06 ENMX 06	40	16	6	40	0,261	ENMX 0604	77 €
T764	D050 d22 Z06 ENMX 06	50	22	6	50	0,478	YG1	83 €
T765	D063 d22 Z07 ENMX 06	63	22	7	50	0,762		90 €
		 TC063 M2,5x7		 T8				



Compatible with YG1 insert. / Kompatibel für YG1 WP

Order Code	Product Code	Dimensions (mm)					Insert	Price
		D	d	Z	H	kg		
T701	D050 d22 Z04 ENMX 09	50	22	4	50	0,487		59 €
T702	D063 d22 Z05 ENMX 09	63	22	5	50	0,796	ENMX 0905	69 €
T703	D080 d27 Z08 ENMX 09	80	27	8	50	1,188	YG1	92 €
T704	D100 d32 Z10 ENMX 09	100	32	10	63	2,867		153 €
T705	D125 d40 Z12 ENMX 09	125	40	12	63	4,186		184 €
		 TC069 M3,5x8,5		 T10				





Compatible with YG1 insert. / Kompatibel für YG1 WP

Order Code	Product Code	Dimensions (mm)					Insert	Price
		D	d	Z	H	kg		
T728	D040 d16 Z06 LNMU 03	40	16	6	40	0,275	LNMU 0303	77 €
T729	D050 d22 Z07 LNMU 03	50	22	7	50	0,541	TNGLY - OKE	90 €
T730	D063 d22 Z09 LNMU 03	63	22	9	50	0,766		107 €
		 TC063 M2,5x7		 T8				



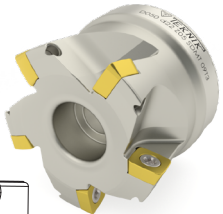
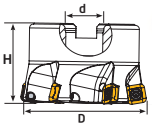

Compatible with TNGLY-OKE insert. / Kompatibel für TNGLY-OKE WP

Order Code	Product Code	Dimensions (mm)					Insert	Price
		D	d	Z	H	kg		
T731	D040 d16 Z06 LOGU 03	40	16	6	40	0,283	LOGU 0303	77 €
T732	D050 d22 Z07 LOGU 03	50	22	7	50	0,582	KYCR	90 €
T734	D063 d22 Z09 LOGU 03	63	22	9	50	1,188		107 €
		 TC064-2 M3x7		 T8				



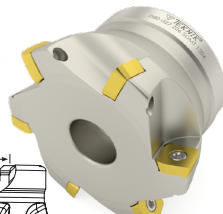
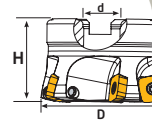

Compatible with KYCR insert. / Kompatibel für KYCR WP

SDMT 09T3	Order Code	Product Code	Dimensions (mm)					Insert	Price
			D	d	Z	H			
	T362	D040 d16 Z04 SDMT 09	40	16	4	40	0,215	SDMT 09T3	54 €
	T363	D050 d22 Z05 SDMT 09	50	22	5	40	0,355	ZCC	69 €
	T364	D063 d22 Z06 SDMT 09	63	22	6	40	0,592		79 €
		 TC067 M3,5x8,5			 T15				



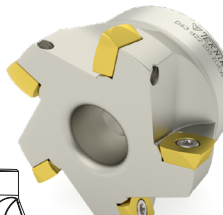
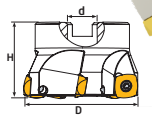

Compatible with ZCC insert. / Kompatibel für ZCC WP

SDMT 1204	Order Code	Product Code	Dimensions (mm)					Insert	Price
			D	d	Z	H			
	T358	D050 d22 Z04 SDMT 12	50	22	4	40	0,315	SDMT 1204	59 €
	T359	D063 d22 Z05 SDMT 12	63	22	5	40	0,422	ZCC	74 €
	T360	D080 d27 Z06 SDMT 12	80	27	6	52	1,051		87 €
		 TC074 M4x10			 T15				



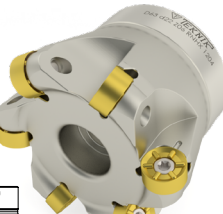
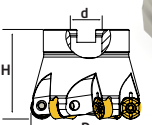

Compatible with ZCC insert. / Kompatibel für ZCC WP

ZDEW 1204	Order Code	Product Code	Dimensions (mm)					Insert	Price
			D	d	Z	H			
	T196	D050 d22 Z04 ZDEW 12	50	22	4	40	0,256	ZDEW 1204	59 €
	T197	D063 d22 Z05 ZDEW 12	63	22	5	40	0,474	PRMT	74 €
		 TC080-1M4,5x11			 T15				

Compatible with PRMT insert. / Kompatibel für PRMT WP

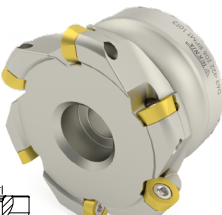
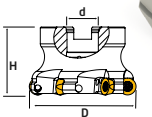
RNHX 1204	Order Code	Product Code	Dimensions (mm)					Insert	Price
			D	d	Z	H			
	T661	D050 d22 Z05 RNHX 12	50	22	5	40	0,284	RNHX 1204	70 €
	T662	D063 d22 Z06 RNHX 12	63	22	6	50	0,637	PLBT	81 €
	T664	D100 d32 Z08 RNHX 12	100	32	8	50	1,570		120 €
		 TC074 M4x10			 T15				

Compatible with PLBT insert. / Kompatibel für PLBT WP

RPMW 10T3	Order Code	Product Code	Dimensions (mm)					Insert	Price
			D	d	Z	H			
	T706	D040 d16 Z05 RPMW 10	40	16	5	40	0,240		70 €
	T707	D050 d22 Z06 RPMW 10	50	22	6	40	0,359	RPMW 10T3	79 €
	T708	D063 d22 Z06 RPMW 10	63	22	6	40	0,584	KRLY	81 €
	T709	D080 d27 Z07 RPMW 10	80	27	7	50	1,272		98 €
		 TC067 M3,5x8,5			 T15				

Compatible with KRLY insert. / Kompatibel für KRLY WP



### RPMW 1204

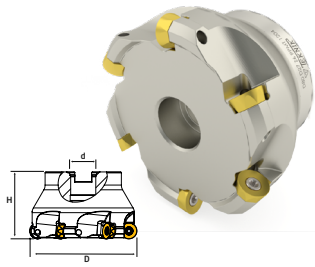

Order Code	Product Code	Dimensions (mm)					Insert	Price
		D	d	Z	H	kg		
T711	D050 d22 Z05 RPMW 12	50	22	5	40	0,327		70 €
T712	D063 d22 Z05 RPMW 12	63	22	5	40	0,556	RPMW 1204	76 €
T713	D080 d27 Z06 RPMW 12	80	27	6	50	0,584	KRLY	92 €
T714	D100 d32 Z07 RPMW 12	100	32	7	53	1,278		108 €
		TC073 M4x8,5		T15 2,027				

Compatible with KRLY insert. / Kompatibel für KRLY WP

### RPMW 1606

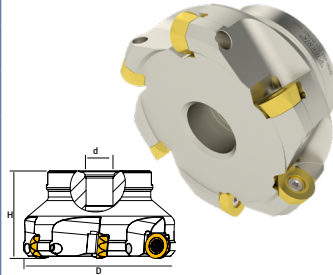

Order Code	Product Code	Dimensions (mm)					Insert	Price
		D	d	Z	H	kg		
T717	D063 d22 Z05 RPMW 16	63	22	5	40	0,509		76 €
T718	D080 d27 Z06 RPMW 16	80	27	6	50	1,048	RPMW 1606	92 €
T719	D100 d32 Z07 RPMW 16	100	32	7	55	0,584	KRLY	108 €
T720	D125 d40 Z08 RPMW 16	125	40	8	63	1,903		118 €
		TC083 M5x12		T20 3,775				

Compatible with KRLY insert. / Kompatibel für KRLY WP

### RDMT 1003

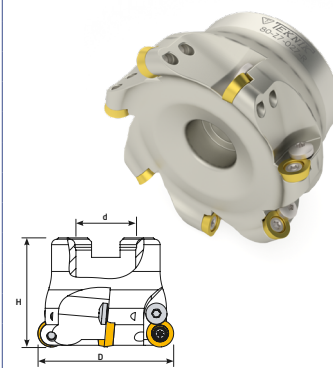

Order Code	Product Code	Dimensions (mm)					Insert	Price
		D	d	Z	H	kg		
T288	D040 d16 Z03 RDMT 10	40	16	3	40	0,208		48 €
T289	D040 d16 Z04 RDMT 10	40	16	4	40	0,220		56 €
T290	D050 d22 Z04 RDMT 10	50	22	4	40	0,310		61 €
T291	D050 d22 Z05 RDMT 10	50	22	5	40	0,302	RDMT 1003	70 €
T292	D063 d22 Z05 RDMT 10	63	22	5	40	0,445	ISO	76 €
T293	D063 d22 Z06 RDMT 10	63	22	6	40	0,460		81 €
T294	D080 d27 Z06 RDMT 10	80	27	6	50	1,033		92 €
T294-1	D080 d27 Z07 RDMT 10	80	27	7	50	1,048		98 €
T295	D100 d32 Z07 RDMT 10	100	32	7	50	1,463		108 €
T295-1	D100 d32 Z08 RDMT 10	100	32	8	50	1,478		114 €
		TC040 M3,5		TC040 M3,5		T15		

### RDMT 12T3

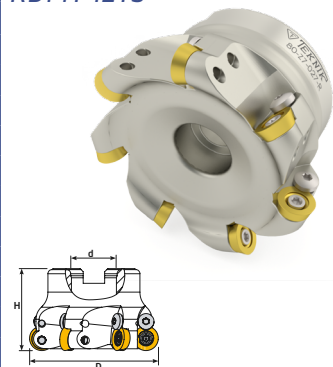

Order Code	Product Code	Dimensions (mm)					Insert	Price
		D	d	Z	H	kg		
T280	D040 d16 Z03 RDMT 12	40	16	3	40	0,235		48 €
T281	D040 d16 Z04 RDMT 12	40	16	4	40	0,236		56 €
T282	D050 d22 Z04 RDMT 12	50	22	4	40	0,311		61 €
T283	D050 d22 Z05 RDMT 12	50	22	5	40	0,309	RDMT 12T3	70 €
T284	D063 d22 Z05 RDMT 12	63	22	5	40	0,468	ISO	76 €
T285	D063 d22 Z06 RDMT 12	63	22	6	40	0,500		81 €
T286	D080 d27 Z06 RDMT 12	80	27	6	50	0,925		92 €
T286-1	D080 d27 Z07 RDMT 12	80	27	7	50	0,950		98 €
T287	D100 d32 Z07 RDMT 12	100	32	7	50	1,402		108 €
T287-1	D100 d32 Z08 RDMT 12	100	32	8	50	1,435		114 €
		TC067 M3,5x8,5		TC040 M3,5		T15		

### RDMT 1604

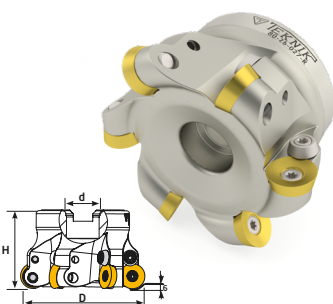

Order Code	Product Code	Dimensions (mm)					Insert	Price	
		D	d	Z	H	kg			
T270	D050 d22 Z04 RDMT 16	50	22	4	50	0,350		61 €	
T271	D052 d22 Z04 RDMT 16	52	22	4	50	0,350	RDMT 1604	61 €	
T273	D063 d22 Z05 RDMT 16	63	22	5	45	0,512	ISO	76 €	
T272	D066 d27 Z05 RDMT 16	66	27	5	50	0,495		76 €	
T274	D080 d27 Z06 RDMT 16	80	27	6	50	0,890		92 €	
T275	D100 d32 Z07 RDMT 16	100	32	7	52	1,370		108 €	
		TC074 M4x10		BK035		TC080 M4,5x11		T15	

### RDMT 12T3

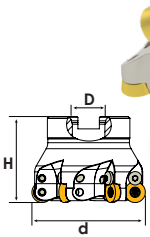

Order Code	Product Code	Dimensions (mm)					Insert	Price
		D	d	Z	H	kg		
T667	D052 d22 Z05 RDMT 12	52	22	5	50	0,403	RDMT 12T3	70 €
T668-1	D066 d27 Z06 RDMT 12	66	27	6	50	0,670	PLBT	81 €
T668	D080 d27 Z07 RDMT 12	80	27	7	50	1,181		98 €

TC067 M3,5x8,5    
 TC040 M3,5    
 T15    

Compatible with PLBT insert. / Kompatibel für PLBT WP

### RCKT 1204

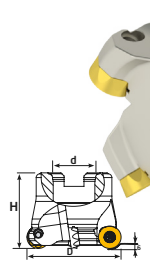

Order Code	Product Code	Dimensions (mm)					Insert	Price
		D	d	Z	H	kg		
T460	D050 d22 Z04 RCKT 12	50	22	4	40	0,287		61 €
T462	D063 d22 Z05 RCKT 12	63	22	5	40	0,436	RCKT 1204	76 €
T464	D080 d27 Z06 RCKT 12	80	27	6	50	1,088	SNDVK	92 €
T466	D100 d32 Z07 RCKT 12	100	32	7	52	1,608		108 €

TC067 M3,5x8,5    
 T15    

Compatible with SNDVK insert. / Kompatibel für SNDVK WP

### RHKW 0802



Order Code	Product Code	Dimensions (mm)					Insert	Price
		D	d	Z	H	kg		
T599	D040 d16 Z04 RHKW 08	40	16	4	40	0,247	RHKW 0802	56 €
T600	D050 d22 Z05 RHKW 08	50	22	5	40	0,309	INGRSLL	70 €
T601	D063 d22 Z06 RHKW 08	63	22	6	40	0,530		81 €

TC065-1 M3x7    
 TC040 M3,5    
 T15    

Compatible with INGRSLL insert. / Kompatibel für INGRSLL WP

### RHKW 1003

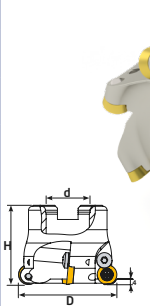

Order Code	Product Code	Dimensions (mm)					Insert	Price
		D	d	Z	H	kg		
T602	D040 d16 Z04 RHKW 10	40	16	4	40	0,243	RHKW 1003	56 €
T604	D050 d22 Z05 RHKW 10	50	22	5	40	0,289	INGRSLL	70 €
T606	D063 d22 Z06 RHKW 10	63	22	6	40	0,488		81 €
T608	D080 d27 Z07 RHKW 10	80	27	7	50	1,080		98 €

TC074 M4x10    
 TC040 M3,5    
 T15    

Compatible with INGRSLL insert. / Kompatibel für INGRSLL WP

### RHKW 1204

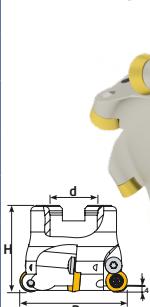

Order Code	Product Code	Dimensions (mm)					Insert	Price
		D	d	Z	H	kg		
T612	D040 d16 Z04 RHKW 12	40	16	4	40	0,246	RHKW 1204	56 €
T613	D050 d22 Z05 RHKW 12	50	22	5	40	0,304	INGRSLL	70 €
T614	D063 d22 Z06 RHKW 12	63	22	6	40	0,556		81 €
T615	D080 d27 Z07 RHKW 12	80	27	7	50	1,039		98 €

TC074 M4x10    
 TC040 M3,5    
 T15    

Compatible with INGRSLL insert. / Kompatibel für INGRSLL WP

**90° APMT 0602**

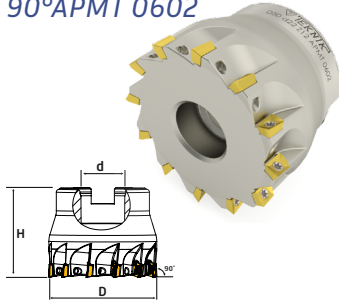

Order Code	Product Code	Dimensions (mm)					Insert	Price
		D	d	Z	H	kg		
T596	D40 d16 Z10 APMT 06	40	16	10	40	0,281	APMT 0602	131 €
T597	D50 d22 Z12 APMT 06	50	22	12	40	0,435	KRLY	157 €
T598	D63 d22 Z14 APMT 06	63	22	14	40	0,715		184 €
T239	D40 d16 Z05 APMT 09	40	16	5	40	0,248	APMT 0602	69 €
T240	D50 d22 Z06 APMT 09	50	22	6	40	0,348	KRLY	76 €

**Code**

T596-T598	TC057-1 M1,8x4,1	T6
T239-T240	TC060 M2,5x5,5	T8

Compatible with KRLY insert. / Kompatibel für KRLY WP

**90° APMT 11T3**

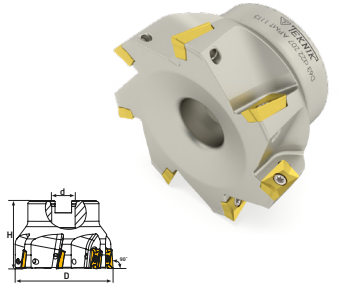

Order Code	Product Code	Dimensions (mm)					Insert	Price
		D	d	Z	H	kg		
T250	D040 d16 Z05 APMT 11	40	16	5	40	0,220		69 €
T252	D050 d22 Z06 APMT 11	50	22	6	40	0,332	APMT 11T3	76 €
T254	D063 d22 Z07 APMT 11	63	22	7	40	0,483	KRLY	81 €
T256	D080 d27 Z08 APMT 11	80	27	8	50	1,115		108 €
T258	D100 d32 Z10 APMT 11	100	32	10	63	1,810		131 €

**Code**

TC060 M2,5x5,5	T8
----------------	----

Compatible with KRLY insert. / Kompatibel für KRLY WP

**90° APMT 1604**

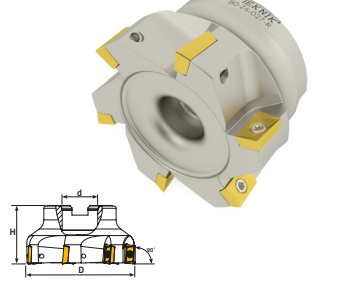

Order Code	Product Code	Dimensions (mm)					Insert	Price
		D	d	Z	H	kg		
T241	D040 d16 Z04 APMT 16	40	16	4	45	0,258		54 €
T243	D050 d22 Z05 APMT 16	50	22	5	45	0,400	APMT 1604	69 €
T245	D063 d22 Z06 APMT 16	63	22	6	45	0,578	KRLY	79 €
T247	D080 d27 Z07 APMT 16	80	27	7	52	1,249		92 €
T249	D100 d32 Z08 APMT 16	100	32	8	52	1,530		114 €

**Code**

TC074 M4x10	T15
-------------	-----

Compatible with KRLY insert. / Kompatibel für KRLY WP

**90° APKT 1604**

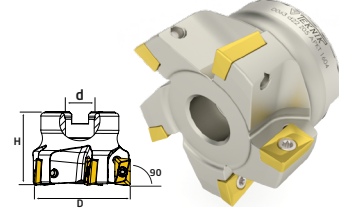

Order Code	Product Code	Dimensions (mm)					Insert	Price
		D	d	Z	H	kg		
T767	D050 d22 Z04 APKT 16	50	22	4	45	0,381	APKT 1604	59 €
T768	D063 d22 Z05 APKT 16	63	22	5	45	0,507	YG1	74 €
T769	D080 d27 Z06 APKT 16	80	27	6	52	1,125		87 €

**Code**

TC074 M4x10	T15
-------------	-----

Compatible with YG1 insert. / Kompatibel für YG1 WP

**90° APKT 1604**

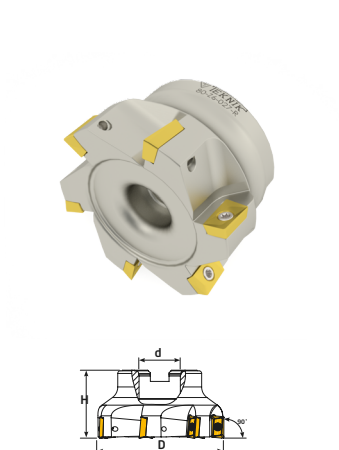

Order Code	Product Code	Dimensions (mm)					Insert	Price
		D	d	Z	H	kg		
T180	D040 d16 Z03 APKT 16	40	16	3	45	0,267		45 €
T181	D040 d16 Z04 APKT 16	40	16	4	45	0,258		54 €
T182	D050 d22 Z04 APKT 16	50	22	4	45	0,406		59 €
T183	D050 d22 Z05 APKT 16	50	22	5	45	0,400		69 €
T184	D063 d22 Z05 APKT 16	63	22	5	45	0,577		74 €
T185	D063 d22 Z06 APKT 16	63	22	6	45	0,578	APKT 1604	79 €
T186	D080 d27 Z06 APKT 16	80	27	6	52	1,159	KRLY	87 €
T187	D080 d27 Z07 APKT 16	80	27	7	52	1,249		92 €
T188	D100 d32 Z07 APKT 16	100	32	7	52	1,057		100 €
T189	D100 d32 Z08 APKT 16	100	32	8	52	1,530		114 €
T190	D125 d40 Z09 APKT 16	125	40	9	62	3,642		141 €
T192	D160 d40 Z10 APKT 16	160	40	10	62	4,885		183 €
T193	D200 d60 Z12 APKT 16	200	60	12	63	6,370		270 €
T195	D300 d60 Z15 APKT 16	300	60	15	62	14,360		539 €

**Code**

TC074 M4x10	T15
-------------	-----

Compatible with KRLY insert. / Kompatibel für KRLY WP

### 90° APXT 1003

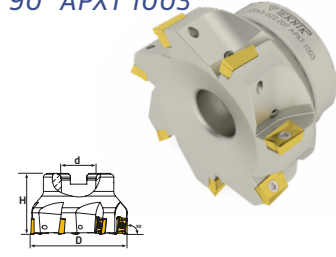

Order Code	Product Code	Dimensions (mm)					Insert	Price
		D	d	Z	H	kg		
T176	D040 d16 Z05 APXT 10	40	16	5	40	0,277		69 €
T177	D050 d22 Z06 APXT 10	50	22	6	40	0,398	APXT 1003	76 €
T178	D063 d22 Z07 APXT 10	63	22	7	40	0,543	KRLY	81 €
T179	D080 d27 Z08 APXT 10	80	27	8	50	1,205		108 €
		TC060 M2,5x5,5		T8				

Compatible with KRLY insert. / Kompatibel für KRLY WP

### 90° XOMX 1204

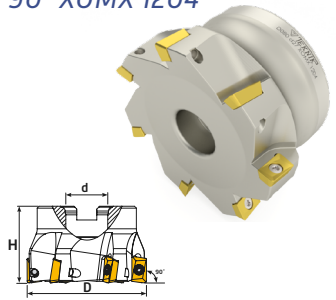

Order Code	Product Code	Dimensions (mm)					Insert	Price
		D	d	Z	H	kg		
T510	D040 d16 Z04 XOMX 12	40	16	4	40	0,250		54 €
T512	D050 d22 Z05 XOMX 12	50	22	5	40	0,351		69 €
T514	D063 d22 Z06 XOMX 12	63	22	6	40	0,618	XOMX 1204	79 €
T516	D080 d27 Z07 XOMX 12	80	27	7	50	1,155	SCO	92 €
T518	D100 d32 Z10 XOMX 12	100	32	10	52	1,817		152 €
T519	D125 d40 Z12 XOMX 12	125	40	12	62	3,565		178 €
		TC069 M3,5x8,5		T10				

Compatible with SCO insert. / Kompatibel für SCO WP

### 90° XOMX 1806

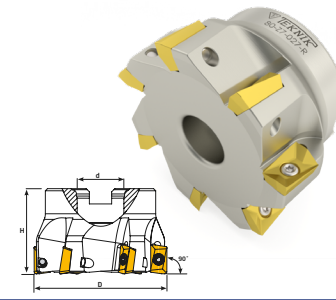

Order Code	Product Code	Dimensions (mm)					Insert	Price
		D	d	Z	H	kg		
T520	D050 d22 Z05 XOMX 18	50	22	5	45	0,337		69 €
T522	D063 d22 Z06 XOMX 18	63	22	6	45	0,550		79 €
T524	D080 d27 Z07 XOMX 18	80	27	7	50	1,082	XOMX 1806	92 €
T525	D100 d32 Z08 XOMX 18	100	32	8	52	1,661	SCO	114 €
T526	D125 d40 Z09 XOMX 18	125	40	9	62	3,427		141 €
T527	D160 d40 Z10 XOMX 18	160	40	10	62	4,831		183 €
		TC080 M4,5x11		T15				

Compatible with SCO insert. / Kompatibel für SCO WP

### 90° R390-11T3

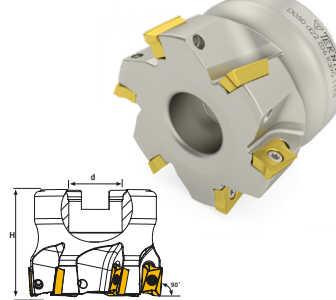

Order Code	Product Code	Dimensions (mm)					Insert	Price
		D	d	Z	H	kg		
T577	D040 d16 Z05 R390 11	40	16	5	40	0,225	R390-11T3	69 €
T578	D050 d22 Z06 R390 11	50	22	6	40	0,355	SNDVK	76 €
T579	D063 d22 Z07 R390 11	63	22	7	40	0,503		81 €
		TC063 M2,5x7		T8				

Compatible with SNDVK insert. / Kompatibel für SNDVK WP

### 90° R390-1704

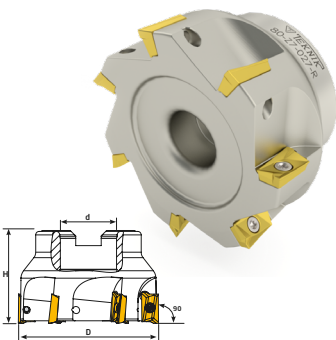

Order Code	Product Code	Dimensions (mm)					Insert	Price
		D	d	Z	H	kg		
T402	D040 d16 Z04 R390 17	40	16	4	45	0,276		54 €
T404	D050 d22 Z05 R390 17	50	22	5	45	0,591		69 €
T408	D063 d22 Z06 R390 17	63	22	6	45	0,590	R390-1704	79 €
T411	D080 d27 Z07 R390 17	80	27	7	52	1,168	SNDVK	92 €
T412	D100 d32 Z08 R390 17	100	32	8	52	1,665		103 €
T414	D125 d40 Z09 R390 17	125	40	9	62	3,680		141 €
T416	D160 d40 Z10 R390 17	160	40	10	62	5,010		183 €
		TC067 M3,5x8,5		T15				

Compatible with SNDVK insert. / Kompatibel für SNDVK WP

**90° R390-1806**



Order Code	Product Code	Dimensions (mm)					Insert	Price
		D	d	Z	H	kg		
T423	D050 d22 Z04 R390 18	50	22	4	45	0,303		59 €
T424	D063 d22 Z05 R390 18	63	22	5	45	0,490	R390-1806	74 €
T426	D080 d27 Z06 R390 18	80	27	6	52	1,081	SNDVK	87 €
T428	D100 d32 Z07 R390 18	100	32	7	52	1,595		103 €
T430	D125 d40 Z08 R390 18	125	40	8	62	3,558		136 €
T432	D160 d40 Z10 R390 18	160	40	10	62	4,411		183 €
		TC074 M4x10		T15				

Compatible with SNDVK insert. / Kompatibel für SNDVK WP

**90° ADMT 1204**

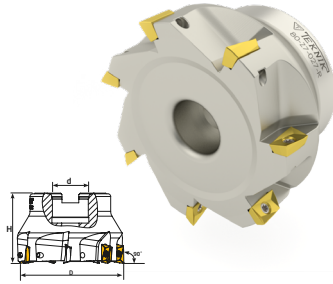

Order Code	Product Code	Dimensions (mm)					Insert	Price
		D	d	Z	H	kg		
T214	D040 d16 Z04 ADMT 12	40	16	4	45	0,280		54 €
T215	D050 d22 Z05 ADMT 12	50	22	5	45	0,350	ADMT 1204	69 €
T217	D063 d22 Z06 ADMT 12	63	22	6	45	0,610	WLTR	79 €
T219	D080 d27 Z07 ADMT 12	80	27	7	52	1,176		92 €
T220	D100 d32 Z08 ADMT 12	100	32	8	52	1,595		114 €
		TC065 M3x7		T8				

Compatible with WLTR insert. / Kompatibel für WLTR WP

**90° ADMT 1606**

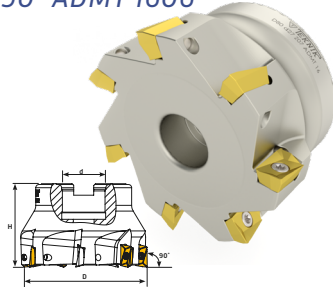

Order Code	Product Code	Dimensions (mm)					Insert	Price
		D	d	Z	H	kg		
T351	D040 d16 Z04 ADMT 16	40	16	4	45	0,258		54 €
T352	D050 d22 Z05 ADMT 16	50	22	5	45	0,397	ADMT 1606	69 €
T354	D063 d22 Z06 ADMT 16	63	22	6	45	0,578	WLTR	79 €
T356	D080 d27 Z07 ADMT 16	80	27	7	52	1,254		92 €
		TC072 M4x10		T15				

Compatible with WLTR insert. / Kompatibel für WLTR WP

**90° BDMT 11T3**

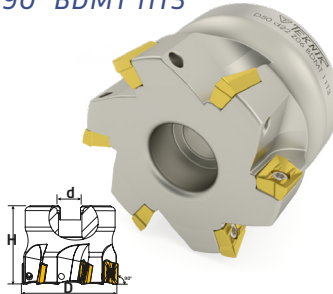

Order Code	Product Code	Dimensions (mm)					Insert	Price
		D	d	Z	H	kg		
T533	D040 d16 Z05 BDMT 11	40	16	5	40	0,224	BDMT 11T3	69 €
T534	D050 d22 Z06 BDMT 11	50	22	6	40	0,361	KYCRA	76 €
T535	D063 d22 Z07 BDMT 11	63	22	7	40	0,527		81 €
		TC060 M2,5x5,5		T8				

Compatible with KYCRA insert. / Kompatibel für KYCRA WP

**90° BDMT 1704**

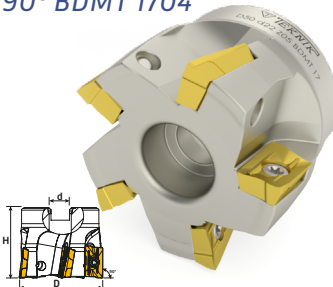

Order Code	Product Code	Dimensions (mm)					Insert	Price
		D	d	Z	H	kg		
T537	D040 d16 Z04 BDMT 17	40	16	4	40	0,190		54 €
T538	D050 d22 Z05 BDMT 17	50	22	5	40	0,312	BDMT 1704	69 €
T539	D063 d22 Z06 BDMT 17	63	22	6	40	0,516	KYCRA	79 €
T540	D080 d27 Z07 BDMT 17	80	27	7	50	1,165		92 €
		TC074 M4x10		T15				

Compatible with KYCRA insert. / Kompatibel für KYCRA WP

### 90° APKT 1705

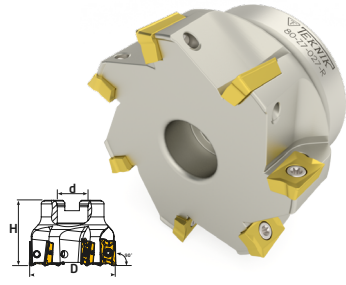

Order Code	Product Code	Dimensions (mm)					Insert	Price
		D	d	Z	H	kg		
T550	D040 d16 Z04 APKT 17	40	16	4	45	0,239		54 €
T552	D050 d22 Z05 APKT 17	50	22	5	45	0,362	APKT 1705	69 €
T554	D063 d22 Z06 APKT 17	63	22	6	45	0,520	TGTC	79 €
T556	D080 d27 Z07 APKT 17	80	27	7	50	1,047		92 €
T558	D100 d32 Z08 APKT 17	100	32	8	52	1,620		114 €
		TC074 M4x10		T15				

Compatible with TGTC insert. / Kompatibel für TGTC WP

### 90° ADKT 1505

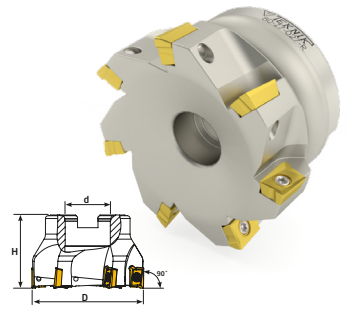

Order Code	Product Code	Dimensions (mm)					Insert	Price
		D	d	Z	H	kg		
T200	D040 d16 Z04 ADKT 15	40	16	4	45	0,270		54 €
T202	D050 d22 Z05 ADKT 15	50	22	5	45	0,394	ADKT 1505	69 €
T204	D063 d22 Z06 ADKT 15	63	22	6	45	0,565	ISCR	79 €
T206	D080 d27 Z07 ADKT 15	80	27	7	52	1,152		92 €
T207	D100 d32 Z08 ADKT 15	100	32	8	52	1,546		114 €
T208	D125 d40 Z09 ADKT 15	125	40	9	62	0,272		141 €
		TC074 M4x10		T15				

Compatible with ISCR insert. / Kompatibel für ISCR WP

### 90° BOMT 1304

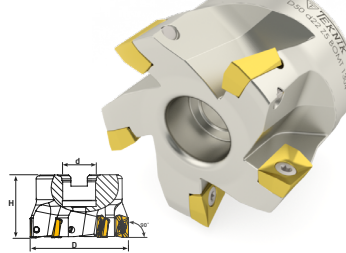

Order Code	Product Code	Dimensions (mm)					Insert	Price
		D	d	Z	H	kg		
T965	D040 d16 Z04 BOMT 13	40	16	4	40	0,272	BOMT 1304	54 €
T966	D050 d22 Z05 BOMT 13	50	22	5	40	0,369	INGRSLL	69 €
T967	D063 d22 Z06 BOMT 13	63	22	6	40	0,613		79 €
		TC069 M3,5x8,5		T10				

Compatible with INGRSLL insert. / Kompatibel für INGRSLL WP

### APKT 16 Chamfering Mill

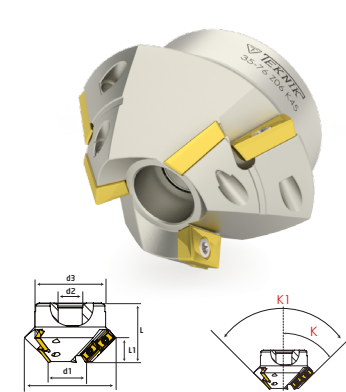

Order Code	Product Code	Dimensions (mm)										Insert	Price
		K	K1	d1	D	Z	d2	d3	L	L1	kg		
T457	35-50,5 Z06 K15° APKT 16	15°	30°	35	50,5	6	22	45	60	30	0,415		108 €
T454	35-65 Z06 K30° APKT 16	30°	60°	35	65	6	27	48	50	26,3	0,610	APKT 1604	108 €
T456	35-76 Z06 K45° APKT 16	45°	90°	35	76	6	27	60	50	21,5	0,734	KRLY	108 €
T455	35-86 Z06 K60° APKT 16	60°	120°	35	86	6	27	60	50	15	0,892		108 €
T458	35-94 Z06 K75° APKT 16	75°	150°	35	94	6	27	60	50	8,5	1,256		108 €
		TC074 M4x10		T15									

Compatible with KRLY insert. / Kompatibel für KRLY WP

### F 75° APKT 1604 - APXT 1003

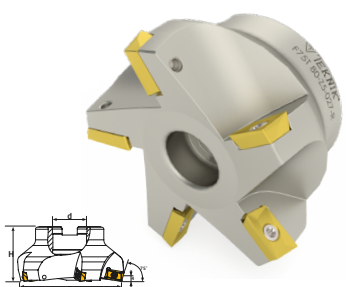

Order Code	Product Code	Dimensions (mm)					Insert	Price			
		D	d	Z	H	kg					
T308	D063 d22 Z04 APKT 16	63	22	4	45	0,510		65 €			
T310	D080 d27 Z05 APKT 16	80	27	5	52	1,120	APKT 1604	80 €			
T312	D100 d32 Z06 APKT 16	100	32	6	52	1,587	KRLY	97 €			
T313	D125 d40 Z07 APKT 16	125	40	7	62	3,047		125 €			
T452	D063 d22 Z06 APXT 10	63	22	6	45	0,630	APXT 1003 KRLY	79 €			
		TC074 M4x10		TC074 M4x10		T15		T8			

Compatible with KRLY insert. / Kompatibel für KRLY WP

**90° VCGT 1604**

Order Code	Product Code	Dimensions (mm)					Insert	Price
		D	d	Z	H			
T498	D040 d16 Z03 VCGT 16	40	16	3	52	0,277		54 €
T500	D050 d22 Z04 VCGT 16	50	22	4	52	0,362	VCGT 1604	69 €
T502	D063 d22 Z05 VCGT 16	63	22	5	52	0,538	ISO	79 €
T504	D080 d27 Z06 VCGT 16	80	27	6	52	0,848		92 €

TC074 M4x10    
 T15    

**F 75° ADKT 1505**

Order Code	Product Code	Dimensions (mm)					Insert	Price
		D	d	Z	H			
T530	D063 d22 Z05 ADKT 15	63	22	5	45	0,580	ADKT 1505	74 €
T532	D080 d27 Z06 ADKT 15	80	27	6	50	1,090	ISCR	92 €

TC074 M4x10    
 T15    

Compatible with ISCR insert. / Kompatibel für ISCR WP

Altıklıklı - With Shim - Mit U-Platte

**TPKN 1603-2204**

Order Code	Product Code	Dimensions (mm)						Insert	Price
		D	d	Z	H	E			
T100	D080 d32 Z05 TPKN 16 A	80	32	5	52	--	0,961	TPKN 1603	116 €
T102	D100 d32 Z06 TPKN 16 A	100	32	6	52	--	1,518	ISO	134 €
T104	D080 d32 Z04 TPKN 22 A	80	32	4	52	--	0,810		113 €
T106	D100 d32 Z05 TPKN 22 A	100	32	5	52	--	1,444	TPKN 2204	128 €
T108	D125 d40 Z06 TPKN 22 A	125	40	6	62	--	3,164	ISO	171 €
T110	D160 d40 Z07 TPKN 22 A	160	40	7	62	66,7	4,220		221 €
T112	D200 d60 Z08 TPKN 22 A	200	60	8	62	101,6	5,412		270 €
T113	D250 d60 Z09 TPKN 22 A	250	60	9	62	101,6	8,166		319 €

**Code**    
 TC052 M6x17    
 4 Allen    
 TA010    
 TC034 M3

T100-T102     TC052 M6x17     4 Allen     TA010     TC034 M3

T104-T113     TC054 M8x24     5 Allen     TA012     TC038 M4x10    

**TPKN 1603-2204**

Order Code	Product Code	Dimensions (mm)						Insert	Price
		D	d	Z	H	E			
T114	D042 d16 Z03 TPKN 16	42	16	3	44	--	0,280		48 €
T116	D050 d22 Z03 TPKN 16	50	22	3	44	--	0,340	TPKN 1603	53 €
T118	D063 d22 Z03 TPKN 16	63	22	3	44	--	0,463	ISO	58 €
T120	D063 d22 Z04 TPKN 16	63	22	4	44	--	0,481		65 €
T122	D080 d32 Z05 TPKN 16	80	32	5	52	--	0,954		86 €
T124	D100 d32 Z06 TPKN 16	100	32	6	52	--	1,542		99 €
T126	D063 d22 Z03 TPKN 22	63	22	3	50	--	0,532		58 €
T128	D080 d32 Z04 TPKN 22	80	32	4	52	--	0,795	TPKN 2204	85 €
T130	D100 d32 Z05 TPKN 22	100	32	5	52	--	1,398	ISO	100 €
T132	D125 d40 Z06 TPKN 22	125	40	6	62	--	3,153		131 €
T134	D160 d40 Z07 TPKN 22	160	40	7	62	66,7	4,150		168 €
T136	D200 d60 Z08 TPKN 22	200	60	8	62	101,6	5,458		230 €
T138	D250 d60 Z09 TPKN 22	250	60	9	62	101,6	8,235		270 €

**Code**    
 TC052 M6x17    
 4 Allen

T114-T124     TC052 M6x17     4 Allen

T126-T138     TC054 M8x24     5 Allen

SPKN 1203

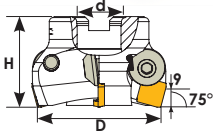
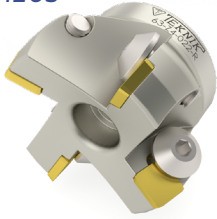

Order Code	Product Code	Dimensions (mm)				Insert	Price
		ØD	ød	Z	H		
T148	D050 d22 Z03 SPKN 12	50	22	3	45	SPKN 1203	53 €
T150	D063 d22 Z04 SPKN 12	63	22	4	45	ISO	65 €
<b>Code</b>		 TC054 M8x24		 5 Allen			

SPKN 1203

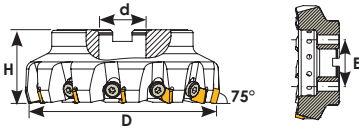

Order Code	Product Code	Dimensions (mm)							Insert	Price
		D	d	Z	H	E	⊗			
T152	D080 d27 Z06 SPKN 12	80	27	6	55	---	1,260		92 €	
T154	D100 d32 Z08 SPKN 12	100	32	8	55	---	1,698	SPKN 1203	119 €	
T156	D125 d40 Z10 SPKN 12	125	40	10	62	---	3,400	ISO	160 €	
T158	D160 d40 Z12 SPKN 12	160	40	12	62	66,7	5,012		212 €	
T160	D200 d60 Z12 SPKN 12	200	60	12	62	101,6	6,542		263 €	
T162	D300 d60 Z20 SPKN 12	300	60	20	65	101,6	15,11		605 €	
<b>Code</b>		 TC056 Sol M8x24-L		 5 Allen						



## Boring Tools



[www.teknikcuttingtools.com](http://www.teknikcuttingtools.com)



THB 01 SET 9-130 mm

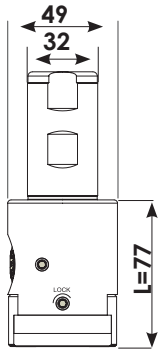
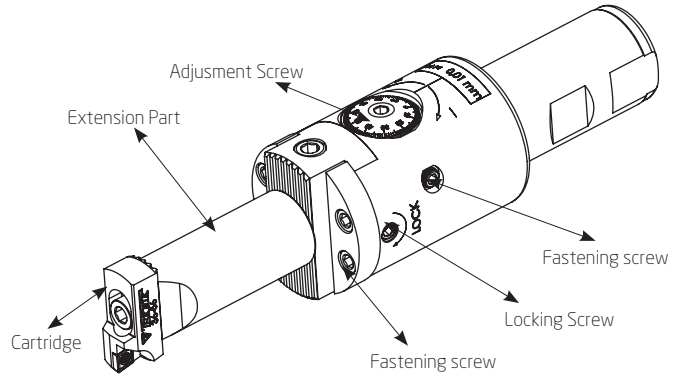
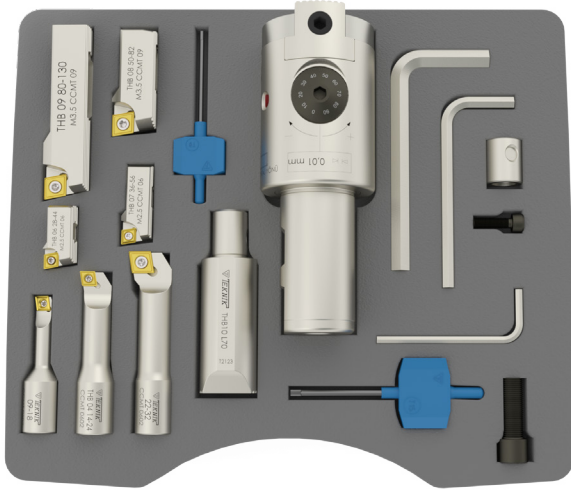

**THB 02**  
**GÖVDE**  
**BODY**  
**Fine / Fein**

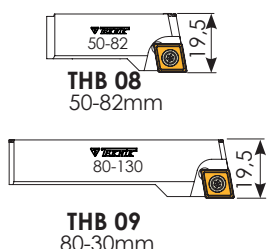
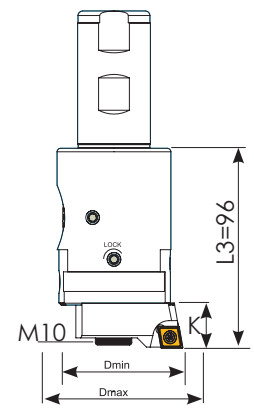
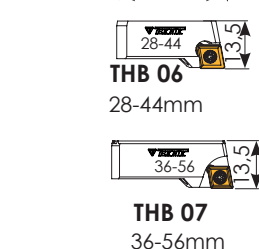
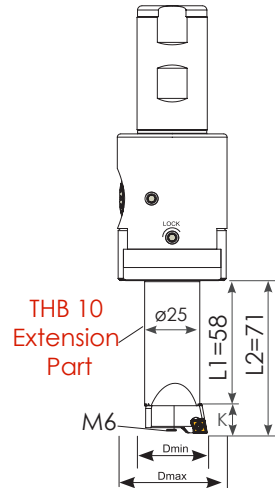
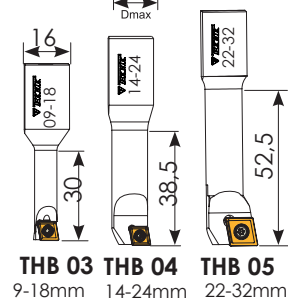
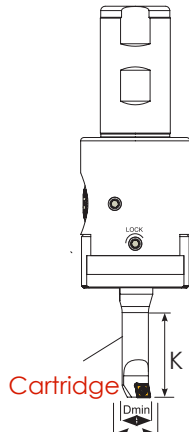
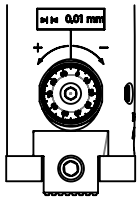

Order Code	Product Code	K	L1	L2	L3	Dmin - Dmax	kg		Price
THB01	Boring Tools Finish SETİ / SET	...	...	...	...	9-130	3,100	...	875 €
THB02	BODY	...	...	...	...	...	-	...	451 €
THB03	09-18 Cartridge	32,5	...	...	...	9-18	-	CCMT 0602	39 €
THB04	14-24 Cartridge	39,6	...	...	...	14-24	-	CCMT 0602	50 €
THB05	22-32 Cartridge	52,5	...	...	...	22-32	-	CCMT 09T3	58 €
THB06	28-44 Cartridge	13,7	...	71	...	28-44	-	CCMT 0602	58 €
THB07	36-56 Cartridge	13,7	...	71	...	36-56	-	CCMT 0602	58 €
THB08	50-82 Cartridge	19,5	...	...	95,5	50-82	-	CCMT 09T3	69 €
THB09	80-130 Cartridge	19,5	...	...	95,5	80-130	-	CCMT 09T3	76 €
THB10	Extension Part	...	58	...	...	...	-	...	50 €

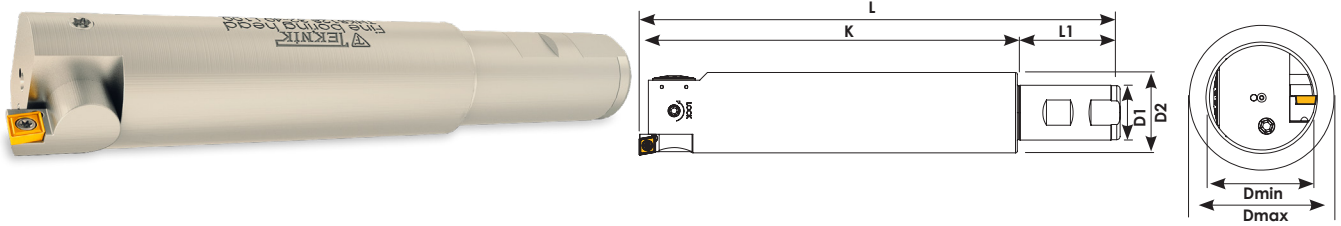

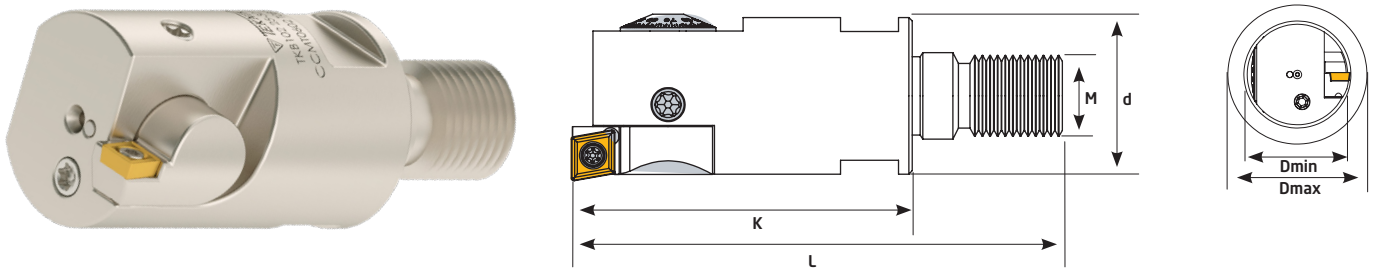

Order Code	Product Code	Dimensions (mm)								Insert	Fine ↔ (mm)	Price
		Dmin	Dmax	K	D1	L1	D2	L	kg			
THKB120	25-32 K050 CCMT 06	25	32	50	25	56	23	106	0,402	CCMT 0602	0,02	408 €
THKB122	25-32 K100 CCMT 06	25	32	100	25	56	23	156	0,570	ISO.		420 €
THKB126	32-40 K060 CCMT 06	32	40	60	25	56	29	116	0,510		0,01	419 €
THKB128	32-40 K104 CCMT 06	32	40	104	25	56	29	160	0,760			433 €
THKB132	40-50 K069 CCMT 06	40	50	69	25	56	36	125	0,722	CCMT 0602	0,01	433 €
THKB134	40-50 K109 CCMT 06	40	50	109	25	56	36	165	1,085			447 €
THKB136	40-50 K189 CCMT 06	40	50	189	25	56	36	245	1,723		0,01	474 €
THKB138	50-65 K065 CCMT 09	50	65	65	32	60	47	125	1,231			439 €
THKB140	50-65 K130 CCMT 09	50	65	130	32	60	47	190	2,135	CCMT 09T3	0,01	461 €
THKB142	50-65 K220 CCMT 09	50	65	220	32	60	47	280	3,383	ISO.		490 €
THKB144	65-80 K085 CCMT 09	65	80	85	32	60	60	145	1,900		0,01	447 €
THKB146	65-80 K130 CCMT 09	65	80	130	32	60	60	190	2,547			474 €
THKB148	65-80 K220 CCMT 09	65	80	220	32	60	60	280	3,895		509 €	

25-40 mm Boring Tools Finish

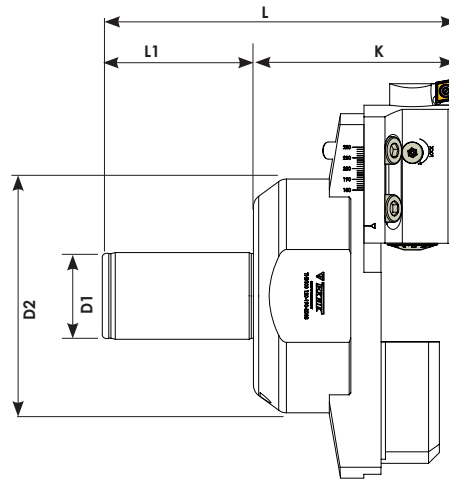
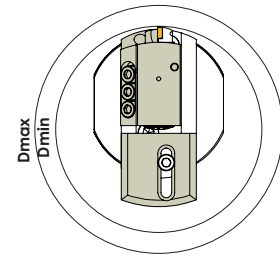

Order Code	Product Code	Dimensions (mm)							Fine ↔ (mm)	Insert	Price
		Dmin	Dmax	M	K	L	d	kg			
THKB102	25-32 K050 M12 CCMT 06	25	32	M12	50	72	23	0,194	0,02	CCMT 0602 ISO.	300 €
THKB104	32-40 K050 M16 CCMT 06	32	40	M16	50	74,3	29	0,287	0,01	CCMT 0602 ISO.	328 €



Order Code	Product Code	Dimensions (mm)								Insert	Price
		Dmin	Dmax	K	D1	L1	D2	L			
THB100	120-190 K093 CCMT 09	120	190	93,7	40	70	109	163,7	5,060	CCMT 09T3	429 €
THB101	180-240 K093 CCMT 09	180	240	93,7	40	70	109	163,7	5,967	ISO.	578 €
THB102	240-300 K093 CCMT 09	240	300	93,7	40	70	109	163,7	7,000		616 €

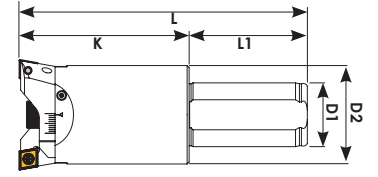
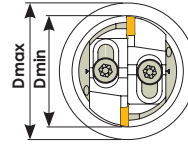

Order Code	Product Code	Dimensions (mm)								Insert	Price
		Dmin	Dmax	K	D1	L1	D2	L			
TKB088	16-20 K052 WCMX 03	16	20	52	16	48	15,7	100	0,176	WCMX 0302	164 €
TKB090	16-20 K102 WCMX 03	16	20	102	16	48	15,7	150	0,237	ISO.	175 €
TKB092	16-20 K152 WCMX 03	16	20	152	16	48	15,7	200	0,362		217 €
TKB094	19-23 K052 CCMT 06	19	23	52	16	48	17,7	100	0,192		164 €
TKB096	19-23 K102 CCMT 06	19	23	102	16	48	17,7	150	0,292	CCMT 0602	175 €
TKB098	19-23 K152 CCMT 06	19	23	152	16	48	17,7	200	0,401	ISO.	217 €
TKB100	23-28 K050 CCMT 06	23	28	50	20	50	21,2	100	0,298		164 €
TKB102	23-28 K100 CCMT 06	23	28	100	20	50	21,2	150	0,347		175 €
TKB104	23-28 K185 CCMT 06	23	28	185	20	50	21,2	235	0,682		217 €
TKB106	28-38 K055 CCMT 09	28	38	55	20	50	25,7	105	0,378		172 €
TKB108	28-38 K105 CCMT 09	28	38	105	20	50	25,7	155	0,376		186 €
TKB110	28-38 K174 CCMT 09	28	38	174	25	56	25,7	230	0,267		223 €
TKB111	28-38 K274 CCMT 09	28	38	274	25	56	25,7	330	1,342		231 €
TKB112	37-48 K064 CCMT 09	37	48	64	25	56	32	120	0,661		175 €
TKB114	37-48 K114 CCMT 09	37	48	114	25	56	33	170	0,991	CCMT 0903	199 €
TKB116	37-48 K204 CCMT 09	37	48	204	25	56	33	260	1,597	ISO.	241 €
TKB118	45-56 K070 CCMT 09	45	56	70	32	60	39,5	130	1,035		179 €
TKB120	45-56 K120 CCMT 09	45	56	120	32	60	40	180	1,528		202 €
TKB122	45-56 K200 CCMT 09	45	56	200	32	60	40	260	2,385		248 €
TKB124	55-75 K085 CCMT 09	55	75	85	32	60	50	145	1,638		199 €
TKB126	55-75 K135 CCMT 09	55	75	135	32	60	50	195	2,422		207 €
TKB128	55-75 K220 CCMT 09	55	75	220	32	60	50	280	3,745		256 €
TKB130	70-90 K085 CCMT 09	70	90	85	32	60	64	145	2,100		202 €
TKB132	70-90 K135 CCMT 09	70	90	135	32	60	64	195	2,942		219 €
TKB134	70-90 K220 CCMT 09	70	90	220	40	70	64	290	4,915		268 €
TKB136	90-130 K115 CCMT 09	90	130	115	32	60	74	175	3,130		234 €
TKB138	90-130 K165 CCMT 09	90	130	165	32	60	74	225	4,138		262 €

Cartridge

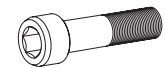
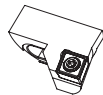
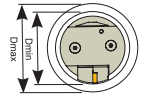
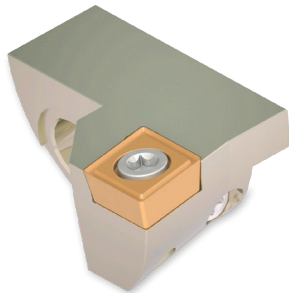

Order Code	Dmin-Dmax	Insert	Price
KR096	16-20	WCMX 0302	62 €
KR098	19-23	CCMT 0602	62 €
KR100	23-28	CCMT 0602	62 €
KR102	28-38	CCMT 09T3	65 €
KR104	37-48	CCMT 09T3	67 €
KR106	45-56	CCMT 09T3	69 €
KR108	55-75	CCMT 09T3	73 €
KR110	70-90	CCMT 09T3	76 €
KR112	90-130	CCMT 09T3	80 €
KR115	55-75	CCMT 1204	73 €
KR116	70-90	CCMT 1204	76 €
KR117	90-130	CCMT 1204	80 €

Order Code	Screw	Price
TC102	M4x16	2,37 €
TC102	M4x16	2,37 €
TC104	M5x25	2,37 €
TC104	M5x25	2,37 €
TC106	M6x30	2,37 €
TC108	M8x30	2,37 €
TC108	M8x30	2,37 €
TC108	M8x30	2,37 €
TC108	M8x30	2,37 €
TC108	M8x30	2,37 €
TC108	M8x30	2,37 €
TC108	M8x30	2,37 €
TC108	M8x30	2,37 €

16-38 mm Boring Tools

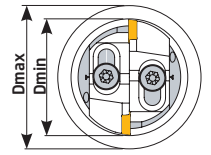
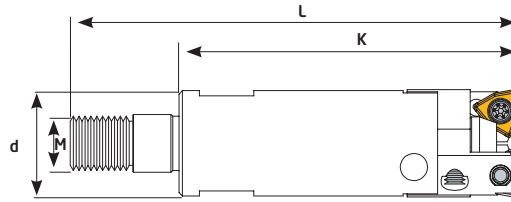

Order Code	Product Code	Dimensions (mm)							Insert	Price
		Dmin	Dmax	M	K	L	d			
TKB170	16-20 K050 M08 WCMX 03	16	20	M08	50	66	15,5	0,078	WCMX 0302 ISO.	152 €
TKB172	19-23 K050 M10 CCMT 06	19	23	M10	50	70	17,5	0,095	CCMT 0602 ISO.	152 €
TKB174	23-28 K050 M12 CCMT 06	23	28	M12	50	72	21,2	0,145	CCMT 0602 ISO.	152 €
TKB176	28-38 K050 M16 CCMT 09	28	38	M16	50	74,5	25,7	0,213	CCMT 09T3 ISO.	163 €

120-350 mm Boring Tools

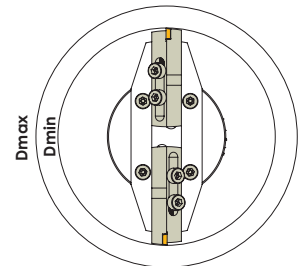
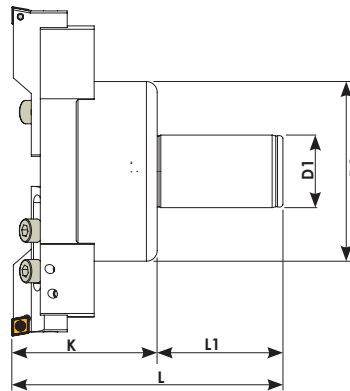

Order Code	Product Code	Dimensions (mm)								Insert	Price
		Dmin	Dmax	K	D1	L1	D2	L			
TKB148	120-170 K069 CCMT 12	120	170	69	40	70	115,5	139	3,281	CCMT 1204	358 €
TKB150	170-250 K084 CCMT 12	170	250	84	40	70	99,5	154	5,011	ISO.	509 €
TKB152	240-350 K084 CCMT 12	240	350	84	40	70	149,5	154	8,294		583 €

Cartridge

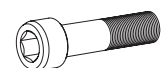
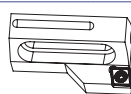
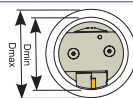
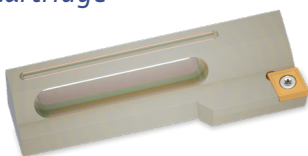

Order Code	Dmin-Dmax	Insert	Price	Order Code	Screw	Price
KR119	120-170	CC MT 1204	109 €	TC109	M8x25	2,37 €
KR120	170-250	CC MT 1204	118 €	TC109	M8x25	2,37 €
KR124	240-350	CC MT 1204	133 €	TC109	M8x25	2,37 €

# Shoulder Milling & Disc Milling



[www.teknikcuttingtools.com](http://www.teknikcuttingtools.com)



Kalite için TEKNİK çözüm  
Technical solution for quality

32-33



### APKT 1604

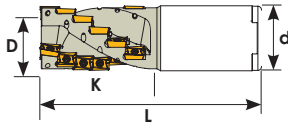
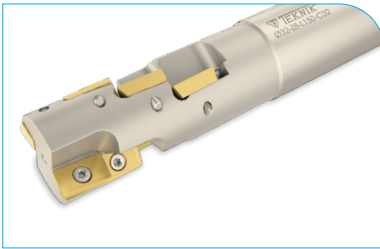

Order Code	Product Code	Dimensions (mm)						Insert	Price
		D	Z	K	d	L			
HF20	D32 Z06 K43 APKT 16	32	6	43	32	125	0,658		264 €
HF22	D40 Z09 K43 APKT 16	40	9	43	32	125	0,821	APKT 1604	314 €
HF24	D32 Z08 K58 APKT 16	32	8	58	32	150	0,771	KRLY	278 €
HF26	D40 Z12 K58 APKT 16	40	12	58	32	150	0,950		327 €
HF30	D32 Z08 K58 APKT 16	32	8	58	32	200	1,120		278 €
HF32	D40 Z12 K58 APKT 16	40	12	58	32	200	1,280		327 €



Compatible with KRLY insert. / Kompatibel für KRLY WP

### APXT 1003

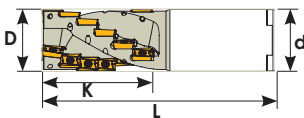
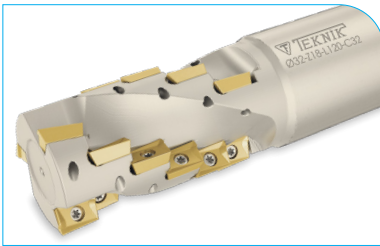

Order Code	Product Code	Dimensions (mm)						Insert	Price
		D	Z	K	d	L			
HF06	D20 Z06 K28 APXT 10	20	6	28	20	120	0,265		196 €
HF07	D25 Z08 K37 APXT 10	25	8	37	25	120	0,404		241 €
HF08	D32 Z15 K46 APXT 10	32	15	46	32	120	0,627		297 €
HF09	D40 Z18 K55 APXT 10	40	18	55	32	125	0,873		350 €
HF10	D20 Z06 K28 APXT 10	20	6	28	20	150	0,326	APXT 1003	196 €
HF11	D25 Z08 K37 APXT 10	25	8	37	25	150	0,515	KRLY	241 €
HF12	D32 Z15 K46 APXT 10	32	15	46	32	150	1,120		297 €
HF13	D40 Z18 K55 APXT 10	40	18	55	32	150	1,100		350 €
HF15	D20 Z06 K28 APXT 10	20	6	28	20	200	0,481		196 €
HF16	D25 Z08 K37 APXT 10	25	8	37	25	200	0,727		241 €
HF17	D32 Z15 K46 APXT 10	32	15	46	32	200	1,144		297 €
HF18	D40 Z18 K55 APXT 10	40	18	55	32	200	1,621		350 €



Compatible with KRLY insert. / Kompatibel für KRLY WP

### APKT 1604

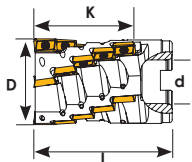

Order Code	Product Code	Dimensions (mm)						Insert	Price
		D	Z	K	d	L			
HF52	D63 Z20 K75 APKT 16	63	20	75	32	100	1,455	APKT 1604	457 €
HF53	D80 Z25 K75 APKT 16	80	25	75	32	100	2,645	KRLY	571 €
HF54	D100 Z30 K75 APKT 16	100	30	75	40	100	4,329		685 €



Compatible with KRLY insert. / Kompatibel für KRLY WP



**SCMT 09T3-1204**

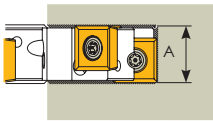
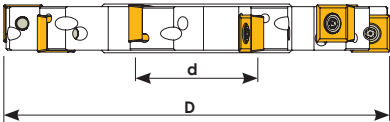
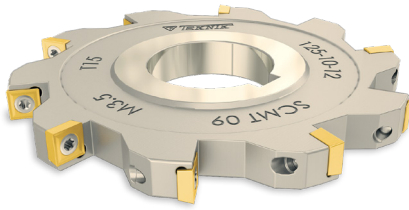

Order Code	Product Code	Dimensions (mm)					kg	Insert	Price
		D	A	Z	d				
DF086	D080 A10 Z08 SCMT 09	80	10	8	27	0,229		155 €	
DF092	D100 A10 Z08 SCMT 09	100	10	8	32	0,408		162 €	
DF100	D125 A10 Z10 SCMT 09	125	10	10	40	0,612		215 €	
DF108	D160 A10 Z12 SCMT 09	160	10	12	40	1,280		293 €	
DF116	D200 A10 Z14 SCMT 09	200	10	14	40	1,738		350 €	
DF088	D080 A12 Z08 SCMT 09	80	12	8	27	0,445	SCMT 09T3	155 €	
DF094	D100 A12 Z08 SCMT 09	100	12	8	32	0,477	ISO.	162 €	
DF102	D125 A12 Z10 SCMT 09	125	12	10	40	0,748		215 €	
DF110	D160 A12 Z12 SCMT 09	160	12	12	40	1,313		293 €	
DF118	D200 A12 Z14 SCMT 09	200	12	14	40	2,140		350 €	
DF090	D080 A16 Z08 SCMT 12	80	16	8	27	0,564		155 €	
DF096	D100 A16 Z08 SCMT 12	100	16	8	32	0,353		162 €	
DF104	D125 A16 Z10 SCMT 12	125	16	10	40	0,927	SCMT 1204	215 €	
DF112	D160 A16 Z12 SCMT 12	160	16	12	40	1,634	ISO.	293 €	
DF120	D200 A16 Z14 SCMT 12	200	16	14	40	2,769		350 €	
DF106	D125 A20 Z10 SCMT 12	125	20	10	40	1,167		215 €	
DF114	D160 A20 Z12 SCMT 12	160	20	12	40	2,145		293 €	

Code		
DF086-DF118	TC074 M4x10	T15
DF090-DF114	TC083 M5x12	T20

**CCMT 0602-09T3-1204**

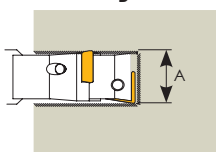
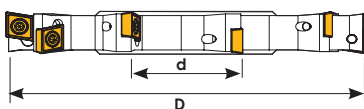
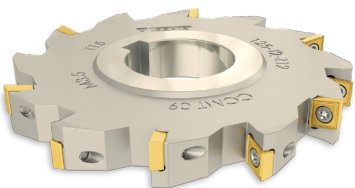

Order Code	Product Code	Dimensions (mm)					kg	Insert	Price
		D	A	Z	d				
DF150	D080 A08 Z10 CCMT 06	80	8	10	27	0,236		155 €	
DF160	D100 A08 Z12 CCMT 06	100	8	12	32	0,365		162 €	
DF170	D125 A08 Z14 CCMT 06	125	8	14	40	0,512		215 €	
DF182	D160 A08 Z16 CCMT 06	160	8	16	40	0,996	CCMT 0602	293 €	
DF194	D200 A08 Z18 CCMT 06	200	8	18	40	1,587	ISO.	350 €	
DF152	D080 A10 Z10 CCMT 06	80	10	10	27	0,289		155 €	
DF162	D100 A10 Z12 CCMT 06	100	10	12	32	0,453		162 €	
DF172	D125 A10 Z14 CCMT 06	125	10	14	40	0,703		215 €	
DF184	D160 A10 Z16 CCMT 06	160	10	16	40	1,228		293 €	
DF196	D200 A10 Z18 CCMT 06	200	10	18	40	2,035		350 €	
DF154	D080 A12 Z08 CCMT 09	80	12	8	27	0,470		155 €	
DF164	D100 A12 Z10 CCMT 09	100	12	10	32	0,472		162 €	
DF174	D125 A12 Z12 CCMT 09	125	12	12	40	0,750		215 €	
DF186	D160 A12 Z14 CCMT 09	160	12	14	40	1,360	CCMT 09T3	293 €	
DF198	D200 A12 Z16 CCMT 09	200	12	16	40	2,400	ISO.	350 €	
DF156	D080 A14 Z08 CCMT 09	80	14	8	27	0,335		155 €	
DF166	D100 A14 Z10 CCMT 09	100	14	10	32	0,552		162 €	
DF176	D125 A14 Z12 CCMT 09	125	14	12	40	0,871		215 €	
DF188	D160 A14 Z14 CCMT 09	160	14	14	40	1,535		293 €	
DF200	D200 A14 Z16 CCMT 09	200	14	16	40	2,575		350 €	
DF158	D080 A16 Z06 CCMT 12	80	16	6	27	0,545		155 €	
DF168	D100 A16 Z08 CCMT 12	100	16	8	32	0,567		162 €	
DF178	D125 A16 Z10 CCMT 12	125	16	10	40	1,121	CCMT 1204	215 €	
DF190	D160 A16 Z12 CCMT 12	160	16	12	40	1,727	ISO.	293 €	
DF180	D125 A20 Z10 CCMT 12	125	20	10	40	1,430		215 €	
DF192	D160 A20 Z12 CCMT 12	160	20	12	40	2,650		293 €	

Code		
DF150-DF196	TC063 M2,5x7	T8
DF0154-DF200	TC067 M3,5x8,5	T15
DF0158-DF192	TC083 M5x12	T20

**Kalite için TEKNİK çözüm**  
Technical solution for quality



# T-Slot Milling Cutter



[www.teknikcuttingtools.com](http://www.teknikcuttingtools.com)



Kalite için TEKNİK çözüm  
Technical solution for quality

36-38



**CCMT 0602-09T3-1204**

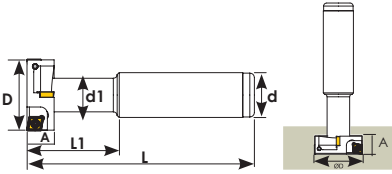
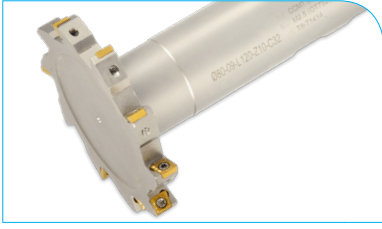

Order Code	Product Code	Dimensions (mm)							Insert	Price	
		D	A	Z	d	d1	L	L1			
TKÇ096	D17 A08 Z02 CCMT 06	17	8	2	16	10	100	28	0,145	CCMT 0602	78 €
TKÇ098	D21 A09 Z02 CCMT 06	21	9	2	16	11	100	31,5	0,151	ISO.	78 €
TKÇ100	D25 A11 Z04 CCMT 06	25	11	4	20	15	100	32,5	1,232		87 €
TKÇ102	D32 A12 Z04 CCMT 06	32	12	4	20	15	100	40	0,300		92 €
TKÇ103	D32 A14 Z04 CCMT 09	32	14	4	25	16	100	33	0,434	CCMT 09T3	92 €
TKÇ104	D35 A15 Z04 CCMT 09	35	15	4	25	14	100	52	0,447	ISO.	92 €
TKÇ106	D40 A17 Z04 CCMT 09	40	17	4	25	20	110	50	0,509		97 €
TKÇ108	D50 A20 Z04 CCMT 12	50	20	4	32	26	110	50	0,691	CCMT 1204 ISO	97 €
TKÇ120	D63 A09 Z08 CCMT 06	63	9	8	32	19,5	125	37	0,842	CCMT 0602	147 €
TKÇ122	D80 A09 Z10 CCMT 06	80	9	10	31,5	32	120	32	1,025	ISO.	163 €

Code	TC	TC
TKÇ096-TKÇ102	TC060 M2,5x5,5	T8
TKÇ103-TKÇ106	TC067 M3,5x8,5	T15
TKÇ108	TC083 M5x12	T20
TKÇ120-TKÇ122	TC060 M2,5x5,5	T8

**SPMG 05-06-07**

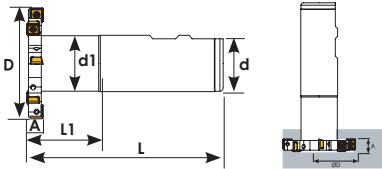
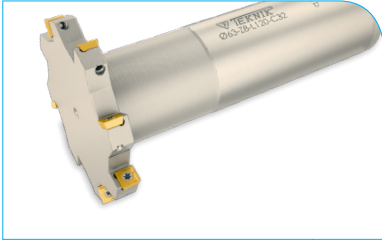

Order Code	Product Code	Dimensions (mm)							Insert	Price	
		D	A	Z	d	d1	L	L1			
TKÇ050	D50 A05 Z07 SPMG 05	50	5	7	32	31,5	120	45	0,830	SPMG 05	132 €
TKÇ052	D63 A05 Z08 SPMG 05	63	5	8	32	31,5	120	45	0,861	TGTC.	146 €
TKÇ054	D50 A06 Z07 SPMG 06	50	6	7	32	31,5	120	45	0,833		132 €
TKÇ056	D63 A06 Z08 SPMG 06	63	6	8	32	31,5	120	45	0,850	SPMG 06	146 €
TKÇ058	D80 A06 Z10 SPMG 06	80	6	10	32	31,5	120	45	0,944	TGTC.	164 €
TKÇ060	D50 A08 Z06 SPMG 06	50	8	6	32	31,5	120	45	0,839		132 €
TKÇ062	D63 A08 Z08 SPMG 06	63	8	8	32	31,5	120	45	0,874		146 €
TKÇ064	D80 A08 Z10 SPMG 06	80	8	10	32	31,5	120	45	0,995		164 €
TKÇ066	D50 A10 Z06 SPMG 07	50	10	6	32	31,5	120	45	0,496	SPMG 07	132 €
TKÇ068	D63 A10 Z08 SPMG 07	63	10	8	32	31,5	120	45	0,868	TGTC.	146 €
TKÇ070	D80 A10 Z10 SPMG 07	80	10	10	32	31,5	120	45	0,994		164 €

Code	TC	TC
TKÇ050-TKÇ052	TC058 M2x4,2	T6
TKÇ054-TKÇ064	TC059 M2,2x5	T7
TKÇ066-TKÇ070	TC063 M2,5x7	T8

Compatible with TGTC insert. / Kompatibel für TGTC WP

**Round Milling Cutter**

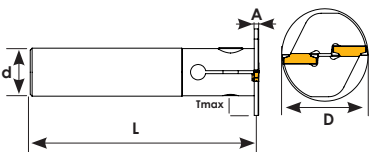

Order Code	Product Code	Dimensions (mm)					Insert	Price		
		D	A	Z	L	d				
TKÇ300	D50 A03 Z02 L-120	50	3	2	120	25	12,75	0,498	MGM 3C	119 €
TKÇ301	D63 A03 Z02 L-120	63	3	2	120	25	19,25	0,543	KRLY.	127 €
TKÇ302	D80 A03 Z02 L-120	80	3	2	120	32	24,25	0,841		152 €
TKÇ303	D50 A04 Z02 L-120	50	4	2	120	25	12,75	0,536	MGM 4C	119 €
TKÇ304	D63 A04 Z02 L-120	63	4	2	120	25	19,25	0,556	KRLY.	127 €
TKÇ305	D80 A04 Z02 L-120	80	4	2	120	32	24,25	0,860		152 €
TKÇ306	D55 A05 Z02 L-120	55	5	2	120	25	15,25	0,513	MGM 5C	119 €
TKÇ307	D63 A05 Z02 L-120	63	5	2	120	25	19,25	0,529	KRLY.	127 €
TKÇ308	D80 A05 Z02 L-120	80	5	2	120	32	24,25	0,860		152 €

TC163 M8	6 Allen
----------	---------

Compatible with KRLY insert. / Kompatibel für KRLY WP

TCMT 1102 16T3

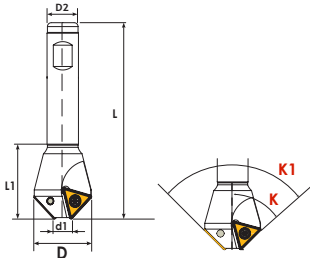
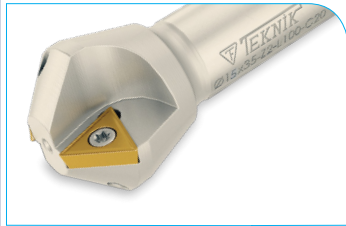

Order Code	Product Code	Dimensions (mm)										Insert	Price
		K	K1	d1	D	Z	d2	L	L1				
S337	06-20 Z01 K30° TCMT 16	30°	60°	6	20	1	16	100	37	0,170	TCMT 16T3	40 €	
S345	10-34 Z02 K30° TCMT 16	30°	60°	10	34	2	20	100	40	0,307	TCMT 16T3	40 €	
S343	24-39 Z02 K30° TCMT 16	30°	60°	24	39	2	20	100	36	0,356	TCMT 16T3	43 €	
S334	04-16 Z01 K45° TCMT 11	45°	90°	4	16	1	16	100	35	0,140	TCMT 1102	40 €	
S341	06-24 Z01 K45° TCMT 16	45°	90°	6	24	1	20	100	30	0,256	TCMT 16T3	43 €	
S336	10-31 Z02 K45° TCMT 16	45°	90°	10	31	2	16	100	35	0,204	TCMT 16T3	40 €	
S338	14-35 Z02 K45° TCMT 16	45°	90°	14	35	2	20	100	35	0,324	TCMT 16T3	40 €	
S340	22-43 Z03 K45° TCMT 16	45°	90°	22	43	3	25	100	37	0,634	TCMT 16T3	43 €	
S342	32-53 Z03 K45° TCMT 16	45°	90°	32	53	3	25	100	37	0,634	TCMT 16T3	43 €	
S335	02-18 Z01 K60° TCMT 11	60°	120°	2	18	1	16	100	35	0,157	TCMT 1102	40 €	
S339	10-31 Z02 K60° TCMT 16	60°	120°	10	31	2	16	100	35	0,213	TCMT 16T3	40 €	
<b>Code</b>													
S337-S343, S341-S342, S339		TC067 M3,5x8,5		T15									
S334, S335		TC060 M2,5x5,5		T8									

Angled Chamfering Mill

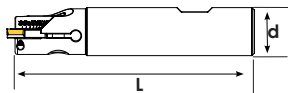

Order Code	Product Code	Dimensions (mm)							Insert	Price
		D min	D max	d	L	Y°				
AH10	D20 R1 L100 TCMT 11	5	27	20	100	10-80	0,241	TCMT 1102 ISO.	94 €	
AH15	D25 R1 L100 TCMT 16	5	34	25	100	10-80	0,370	TCMT 16T3 ISO.	94 €	
<b>Code</b>										
AH10		AH20 TCMT 11		TC063M2,5x7		M5x12		T8		
AH15		AH21 TCMT 16		TC067 M3,5x8,5		M6x15		T15		

TWX 16R

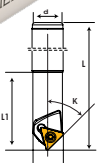
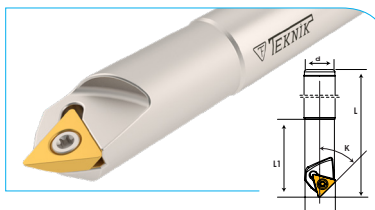

Order Code	Product Code	Dimensions (mm)							Insert	Price
		K	D	Z	L	d	L1			
S352	D21 d20 Z01 L110 TWX 16	45°	21	1	110	20	50	0,260	TWX 16R-KRLY	53 €
		TC072 M4x10		T15						

Compatible with KRLY insert. / Kompatibel für KRLY WP

SOMT 11T3

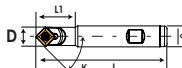

Order Code	Product Code	Dimensions (mm)							Insert	Price
		K	D	Z	L	d	L1			
S769	D16 d16 Z01 L100 SOMT 11	45°	16	1	100	16	32	0,153	SOMT 11T3	53 €
S770	D16 d16 Z01 L150 SOMT 11	45°	16	1	150	16	32	0,238	PLBT	55 €
		TC067 M3,5x8,5		T15						

Compatible with PLBT insert. / Kompatibel für PLBT WP

Back Facing Milling

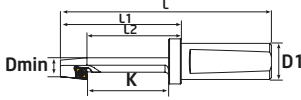
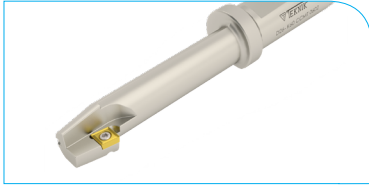

Order Code	Product Code	Dimensions (mm)							Insert	Price	
		D	Dmin	K	L	L1	L2	D1			
C100	D18 K40 CCMT 06	18	10	40	47	60	110	20	0,194	CCMT 060204	97 €
C102	D20 K45 CCMT 06	20	12	45	52	67	117	20	0,210	ISO.	97 €
C104	D26 K60 CCMT 06	26	17	60	67	82	132	20	0,261		97 €
C106	D33 K75 CCMT 09	33	21	75	82	102	152	20	0,308	CCMT 09T304 ISO.	97 €
<b>Code</b>											
C100-C104		TC060 M2,5x5				T8					
C106		TC067 M3,5x8,5				T15					

RHKW 1003

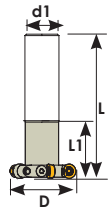

Order Code	Product Code	Dimensions (mm)					Insert	Price	
		D	Z	L	d	L1			
TKÇ200	D40 d20 Z04 L100 RHKW 10	40	4	100	20	40	0,285	RHKW 1003	97 €
TKÇ202	D50 d25 Z05 L120 RHKW 10	50	5	120	25	40	0,284	INGRSLL.	105 €
		TC074 M4x10		TC040 M3,5		T15			

Compatible with INGRSLL insert. / Kompatible für INGRSLL WP

45° SPMG 0904

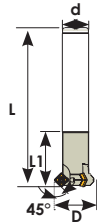
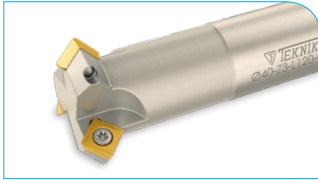

Order Code	Product Code	Dimensions (mm)					Insert	Price	
		D	Z	L	d	L1			
S060	D32 d25 Z02 L150 SPMT 09	32	2	150	25	30	0,589	SPMG 0904	69 €
S062	D40 d25 Z03 L150 SPMT 09	40	3	150	25	50	0,562	TGTC.	73 €
		TC067 M3,5x8,5		T15					

Compatible with TGTC insert. / Kompatible für TGTC WP

55° DCMT 11T3 - 35° VBMT 1604

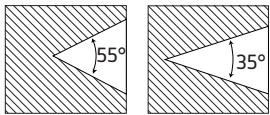
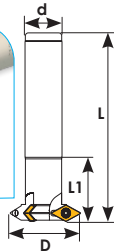

Order Code	Product Code	Dimensions (mm)					Insert	Price	
		D	Z	L	d	L1			
S070	D50 d25 Z03 L120 DCMT 11	50	3	120	25	40	0,584	DCMT 11T3 ISO.	97 €
S072	D63 d25 Z04 L120 DCMT 11	63	4	120	25	40	0,536		105 €
S073	D75 d25 Z03 L130 VBMT 16	75	3	130	25	40	0,924	VBMT 1604 ISO.	99 €
<b>Code</b>									
S070-S072		TC067 M3.5X9				T15			
S073		TC074 M4x10							

55° DCMT 11T3

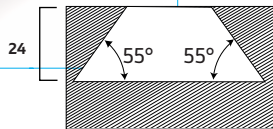
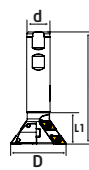
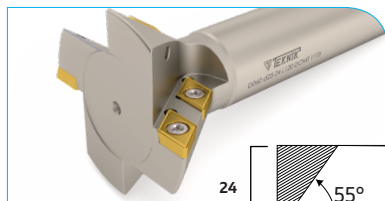

Order Code	Product Code	Dimensions (mm)					Insert	Price	
		D	Z	L	d	L1			
TKÇ251	D60 d25 Z04 L120 DCMT 11	60	4	120	25	35	0,583	DCMT 11T3 ISO.	108 €
		TC067 M3.5X9		T15					

60° DCMT 11T3

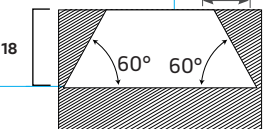
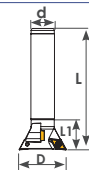
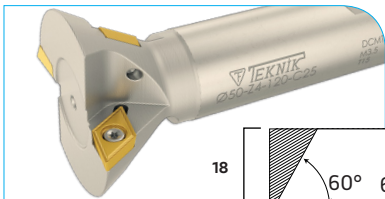

Order Code	Product Code	Dimensions (mm)					Insert	Price	
		D	Z	L	d	L1			
TKÇ250	D50 d25 Z04 L120 DCMT 11	50	4	120	25	30	0,521	DCMT 11T3 ISO.	108 €
		TC067 M3.5X9		T15					

## End Mill



[www.teknikcuttingtools.com](http://www.teknikcuttingtools.com)



Kalite için TEKNİK çözüm

Technical solution for quality

40-55

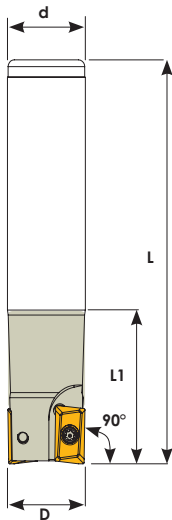

**APXT 1003**

Order Code	Product Code	Dimensions (mm)							Insert	Price
		D	Z	L	d	L1				
S136	D12 d12 Z01 L100 APXT 10	12	1	100	12	27	0,097		35 €	
S138	D14 d14 Z01 L100 APXT 10	14	1	100	14	30	0,126		35 €	
S140	D16 d16 Z02 L100 APXT 10	16	2	100	16	30	0,156		45 €	
S142	D18 d16 Z02 L100 APXT 10	18	2	100	16	30	0,162		45 €	
S144	D20 d20 Z03 L100 APXT 10	20	3	100	20	30	0,231		52 €	
S146	D22 d20 Z03 L100 APXT 10	22	3	100	20	30	0,243		52 €	
S148	D25 d25 Z03 L100 APXT 10	25	3	100	25	35	0,365		53 €	
S150	D30 d25 Z04 L100 APXT 10	30	4	100	25	40	0,400		62 €	
S152	D32 d25 Z04 L100 APXT 10	32	4	100	25	35	0,415		62 €	
S154	D35 d25 Z04 L100 APXT 10	35	4	100	25	30	0,452		62 €	
S156	D40 d25 Z05 L100 APXT 10	40	5	100	25	30	0,477		70 €	
S158	D12 d12 Z01 L120 APXT 10	12	1	120	12	27	0,112		40 €	
S160	D14 d14 Z01 L120 APXT 10	14	1	120	14	30	0,150		40 €	
S162	D16 d16 Z02 L120 APXT 10	16	2	120	16	40	0,185	APXT 1003	46 €	
S164	D18 d16 Z02 L120 APXT 10	18	2	120	16	45	0,190	KRLY.	46 €	
S166	D20 d20 Z03 L120 APXT 10	20	3	120	20	40	0,278		58 €	
S168	D22 d20 Z03 L120 APXT 10	22	3	120	20	40	0,290		58 €	
S169	D25 d25 Z03 L120 APXT 10	25	3	120	25	40	0,452		58 €	
S170	D30 d25 Z04 L120 APXT 10	30	4	120	25	40	0,487		66 €	
S171-1	D32 d25 Z04 L120 APXT 10	32	4	120	25	40	0,511		66 €	
S171	D35 d25 Z04 L120 APXT 10	35	4	120	25	40	0,532		66 €	
S172	D40 d25 Z05 L120 APXT 10	40	5	120	25	40	0,606		76 €	
S173	D16 d16 Z02 L150 APXT 10	16	2	150	16	50	0,230		59 €	
S174	D18 d16 Z02 L150 APXT 10	18	2	150	16	50	0,246		59 €	
S176	D20 d20 Z03 L150 APXT 10	20	3	150	20	60	0,345		65 €	
S178	D22 d20 Z03 L150 APXT 10	22	3	150	20	60	0,360		65 €	
S180	D25 d25 Z03 L150 APXT 10	25	3	150	25	60	0,563		65 €	
S180-1	D30 d25 Z04 L150 APXT 10	30	4	150	25	60	0,610		76 €	
S181	D32 d32 Z04 L150 APXT 10	32	4	150	32	45	0,916		76 €	
S182	D16 d16 Z02 L200 APXT 10	16	2	200	16	60	0,480		69 €	
S184	D18 d16 Z02 L200 APXT 10	18	2	200	16	60	0,350		69 €	
S186	D20 d20 Z03 L200 APXT 10	20	3	200	20	70	0,500		79 €	
S187	D22 d20 Z03 L200 APXT 10	22	3	200	20	70	0,513		79 €	
S188	D25 d25 Z03 L200 APXT 10	25	3	200	25	60	0,771		79 €	
S188-1	D30 d25 Z04 L200 APXT 10	30	4	200	25	50	0,845		91 €	
S189	D32 d32 Z04 L200 APXT 10	32	4	200	32	60	1,253		91 €	
S190	D16 d16 Z02 L250 APXT 10	16	2	250	16	70	0,415		94 €	
S192	D20 d20 Z03 L250 APXT 10	20	3	250	20	70	0,623		106 €	
S194	D25 d25 Z03 L250 APXT 10	25	3	250	25	70	0,953		106 €	

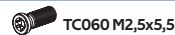

Compatible with KRLY insert. / Kompatibel für KRLY WP



APKT 1604

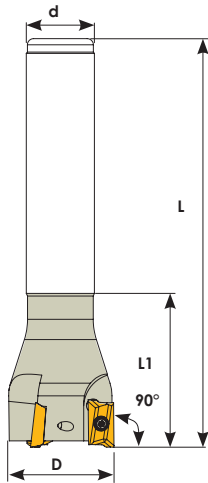

Order Code	Product Code	Dimensions (mm)							Insert	Price
		D	Z	L	d	L1				
S256	D25 d25 Z02 L120 APKT 16	25	2	120	25	45	0,430		50 €	
S258	D30 d25 Z03 L120 APKT 16	30	3	120	25	45	0,460		53 €	
S260	D32 d25 Z03 L120 APKT 16	32	3	120	25	45	0,469		53 €	
S262	D35 d25 Z03 L120 APKT 16	35	3	120	25	45	0,498		53 €	
S264	D40 d25 Z04 L120 APKT 16	40	4	120	25	45	0,547		63 €	
S266	D25 d25 Z02 L150 APKT 16	25	2	150	25	55	0,544		65 €	
S268	D30 d25 Z03 L150 APKT 16	30	3	150	25	55	0,575		69 €	
S270	D32 d32 Z03 L150 APKT 16	32	3	150	32	55	0,876	APKT 1604	69 €	
S272	D35 d32 Z03 L150 APKT 16	35	3	150	32	55	0,915	KRLY.	69 €	
S274	D40 d32 Z04 L150 APKT 16	40	4	150	32	55	0,960		74 €	
S276	D25 d25 Z02 L200 APKT 16	25	2	200	25	65	0,750		72 €	
S278	D30 d25 Z03 L200 APKT 16	30	3	200	25	55	0,783		76 €	
S280	D32 d32 Z03 L200 APKT 16	32	3	200	32	55	1,218		76 €	
S282	D35 d32 Z03 L200 APKT 16	35	3	200	32	55	1,245		76 €	
S283	D40 d32 Z04 L200 APKT 16	40	4	200	32	55	1,296		87 €	
S432	D25 d25 Z02 L250 APKT 16	25	2	250	25	70	0,939		89 €	
S434	D30 d25 Z03 L250 APKT 16	30	3	250	25	55	1,028		94 €	
S436	D32 d32 Z03 L250 APKT 16	32	3	250	32	60	1,520		94 €	
S438	D35 d32 Z03 L250 APKT 16	35	3	250	32	65	1,567		94 €	
S440	D40 d32 Z04 L250 APKT 16	40	4	250	32	60	1,612		102 €	
S442	D25 d25 Z02 L300 APKT 16	25	2	300	25	70	1,127		98 €	
S444	D30 d25 Z03 L300 APKT 16	30	3	300	25	60	1,168		106 €	
S446	D32 d32 Z03 L300 APKT 16	32	3	300	32	70	1,827		106 €	
S448	D35 d32 Z03 L300 APKT 16	35	3	300	32	65	1,879		106 €	
S450	D40 d32 Z04 L300 APKT 16	40	4	300	32	70	1,922		116 €	
S453	D32 d32 Z03 L350 APKT 16	32	3	350	32	80	2,274		127 €	
S454	D35 d32 Z03 L350 APKT 16	35	3	350	32	65	2,332		127 €	
S456	D40 d32 Z04 L350 APKT 16	40	4	350	32	55	2,375		136 €	



Compatible with KRLY insert. / Kompatibel für KRLY WP.

### APMT 0602

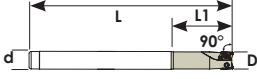
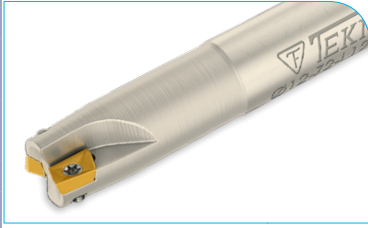

Order Code	Product Code	Dimensions (mm)						Insert	Price
		D	Z	L	d	L1			
S003	D10 d10 Z02 L080 APMT 06	10	2	80	10	20	0,041		55 €
S027	D10 d10 Z02 L100 APMT 06	10	2	100	10	30	0,051		55 €
S009	D10 d10 Z02 L120 APMT 06	10	2	120	10	30	0,085		64 €
S004	D12 d12 Z03 L080 APMT 06	12	3	80	12	25	0,060	APMT 0602	62 €
S028	D12 d12 Z03 L100 APMT 06	12	3	100	12	25	0,075	KRLY.	62 €
S011	D12 d12 Z02 L120 APMT 06	12	2	120	12	30	0,120		64 €
S005	D16 d16 Z04 L090 APMT 06	16	4	90	16	25	0,120		73 €
S029	D16 d16 Z04 L120 APMT 06	16	4	120	16	25	0,164		75 €
S006	D20 d20 Z05 L110 APMT 06	20	5	110	20	30	0,240		86 €
S030	D20 d20 Z05 L120 APMT 06	20	5	120	20	30	0,263		87 €
S007	D25 d25 Z07 L120 APMT 06	25	7	120	25	30	0,411		92 €
S008	D32 d32 Z08 L120 APMT 06	32	8	120	32	35	0,686		106 €



Compatible with KRLY insert. / Kompatibel für KRLY WP

### APMT 0903



Order Code	Product Code	Dimensions (mm)						Insert	Price
		D	Z	L	d	L1			
S047	D16 d16 Z02 L120 APMT 09	16	2	120	16	30	0,158		45 €
S048	D20 d16 Z03 L120 APMT 09	20	3	120	20	30	0,261	APMT 0903	58 €
S049	D25 d25 Z04 L130 APMT 09	25	4	130	25	30	0,438	KRLY.	66 €
S050	D32 d32 Z05 L130 APMT 09	32	5	130	32	30	0,732		97 €



KRLY ucuna uygundur.

### APMT 11T3

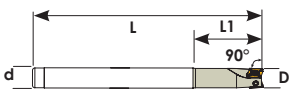

Order Code	Product Code	Dimensions (mm)						Insert	Price
		D	Z	L	d	L1			
S222	D10 d10 Z01 L085 APMT 11	10	1	85	10	20	0,059		35 €
S224	D12 d16 Z01 L085 APMT 11	12	1	85	16	25	0,126		35 €
S226	D14 d16 Z01 L090 APMT 11	14	1	90	16	25	0,139		35 €
S228	D16 d16 Z02 L090 APMT 11	16	2	90	16	25	0,138		45 €
S230	D16 d16 Z02 L180 APMT 11	16	2	180	16	30	0,280	APMT 11T3	62 €
S232	D20 d20 Z02 L100 APMT 11	20	2	100	20	30	0,243	KRLY.	52 €
S234	D20 d20 Z02 L210 APMT 11	20	2	210	20	30	0,523		79 €
S236	D25 d25 Z03 L115 APMT 11	25	3	115	25	35	0,423		58 €
S238	D25 d25 Z03 L180 APMT 11	25	3	180	25	40	0,749		79 €
S240	D32 d32 Z04 L125 APMT 11	32	4	125	32	40	0,764		66 €
S242	D32 d32 Z04 L180 APMT 11	32	4	180	32	50	1,123		91 €

Code

S222-S238  
S240-S242



TC060 N2,5x5,5  
TC061 M2,5x6,5



T8



Compatible with KRLY insert. / Kompatibel für KRLY WP

### APMT 1604

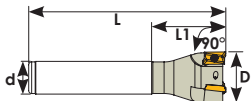
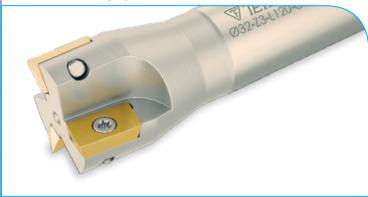

Order Code	Product Code	Dimensions (mm)						Insert	Price
		D	Z	L	d	L1			
S244	D25 d25 Z02 L120 APMT 16	25	2	120	25	45	0,430		50 €
S245	D25 d25 Z02 L150 APMT 16	25	2	150	25	55	0,610	APMT 1604	65 €
S247	D32 d25 Z03 L120 APMT 16	32	3	120	25	45	0,495	KRLY.	53 €
S248	D32 d32 Z03 L150 APMT 16	32	3	150	32	55	0,874		69 €
S250	D40 d25 Z04 L120 APMT 16	40	4	120	25	45	0,544		63 €
S251	D40 d32 Z04 L150 APMT 16	40	4	150	32	55	1,294		74 €

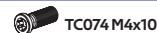

Compatible with KRLY insert. / Kompatibel für KRLY WP

**APKT 1003-1604**

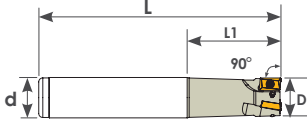

Order Code	Product Code	Dimensions (mm)						Insert	Price
		D	Z	L	d	L1			
S031	D16 d16 Z02 L100 APKT 10	16	2	100	16	30	0,275		₺714
S032	D20 d20 Z03 L100 APKT 10	20	3	100	20	30	0,342		₺755
S033	D25 d25 Z03 L100 APKT 10	25	3	100	25	35	0,376	APKT 1003	₺755
S034	D32 d25 Z04 L100 APKT 10	32	4	100	25	35	0,768	YG1	₺892
S035	D16 d16 Z02 L150 APKT 10	16	2	150	16	50	0,320		₺855
S036	D20 d20 Z03 L150 APKT 10	20	3	150	20	60	0,368		₺935
S037	D25 d25 Z03 L150 APKT 10	25	3	150	25	60	0,541		₺935
S038	D32 d32 Z04 L150 APKT 10	32	4	150	32	45	0,946		₺1.110
S046	D40 d25 Z04 L120 APKT 16	40	4	120	25	45	0,516	APKT 1604 YG1	₺993
<b>Code</b>									
S031-S032,S035-S036		TC060 M2,5x5,5				T8			
S033-S034,S038		TC063 M2,5x7				T15			
S046		TC074 M4x10				T15			

YG1 ucuna uygundur.

**R390-11T3 -1704-1806**

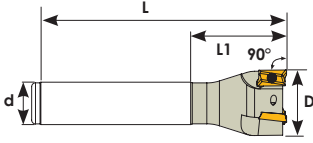
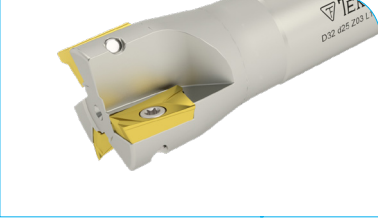

Order Code	Product Code	Dimensions (mm)						Insert	Price
		D	Z	L	d	L1			
S591	D16 d16 Z02 L120 R390 11	16	2	120	16	40	0,180		₺736
S592	D20 d20 Z03 L120 R390 11	20	3	120	20	40	0,270		₺794
S592-1	D25 d25 Z03 L120 R390 11	25	3	120	25	45	0,446		₺794
S593	D16 d16 Z02 L150 R390 11	16	2	150	16	40	0,229	R390-11T3	₺872
S594	D20 d20 Z03 L150 R390 11	20	3	150	20	50	0,348	SNDVK.	₺872
S594-1	D21 d20 Z03 L150 R390 11	21	3	150	20	50	0,366		₺935
S595	D25 d25 Z03 L150 R390 11	25	3	150	25	50	0,557		₺935
S595-1	D26 d25 Z04 L150 R390 11	26	4	150	25	50	0,557		₺1.073
S596	D20 d20 Z03 L200 R390 11	20	3	200	20	50	0,480		₺1.110
S597	D25 d25 Z03 L200 R390 11	25	3	200	25	50	0,762		₺1.110
S598	D25 d25 Z03 L250 R390 11	25	3	250	25	60	0,951		₺1.507
S510	D25 d25 Z02 L120 R390 17	25	2	120	25	45	0,425		₺696
S512	D30 d25 Z03 L120 R390 17	30	3	120	25	45	0,461		₺872
S514	D32 d25 Z03 L120 R390 17	32	3	120	25	45	0,459		₺872
S518	D40 d32 Z04 L120 R390 17	40	4	120	32	45	0,782		₺974
S520	D25 d25 Z02 L150 R390 17	25	2	150	25	55	0,536	R390-1704	₺892
S522	D30 d25 Z03 L150 R390 17	30	3	150	25	55	0,582	SNDVK.	₺993
S524	D32 d32 Z03 L150 R390 17	32	3	150	32	55	0,854		₺993
S528	D40 d32 Z04 L150 R390 17	40	4	150	32	55	0,936		₺1.014
S530	D25 d25 Z02 L200 R390 17	25	2	200	25	60	0,741		₺1.032
S532	D30 d25 Z03 L200 R390 17	30	3	200	25	55	0,773		₺1.092
S534	D32 d32 Z03 L200 R390 17	32	3	200	32	55	0,781		₺1.092
S538	D40 d32 Z04 L200 R390 17	40	4	200	32	55	1,272		₺1.232
S603	D25 d25 Z02 L150 R390 18	25	2	150	25	60	0,530		₺892
S600	D25 d25 Z02 L200 R390 18	25	2	200	25	60	0,756	R390-1806	₺993
S605	D32 d32 Z03 L150 R390 18	32	3	150	32	60	0,850	SNDVK.	₺1.014
S601	D32 d32 Z03 L200 R390 18	32	3	200	32	60	1,188		₺1.092
<b>Code</b>									
S591,S593,S594-1,S596		TC060 M2,5x5,5				T8			
S592,S592-1, S594,S595,S595-1		TC063 M2,5x7				T15			
S597,S598						T15			
S510,S538		TC067 M3,5x8,5				T15			
S603,S601		TC074 M4x10				T15			

SNDVK ucuna uygundur.

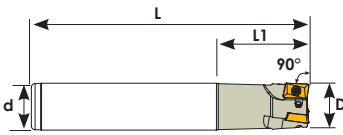
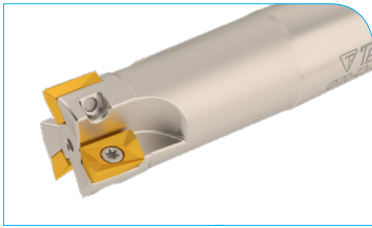
**XOMX 0602- 0903-1204**

Order Code	Product Code	Dimensions (mm)					kg	Insert	Price
		D	Z	L	d	L1			
S623	D10 d10 Z02 L120 XOMX 06	10	2	120	10	40	0,086	XOMX 0602	64 €
S625	D12 d12 Z02 L120 XOMX 06	12	2	120	12	30	0,119	SCO.	64 €
S627	D16 d16 Z02 L120 XOMX 09	16	2	120	16	45	0,197		46 €
S626	D20 d20 Z03 L120 XOMX 09	20	3	120	20	40	0,297	XOMX 0903	58 €
S629	D16 d16 Z02 L150 XOMX 09	16	2	150	16	45	0,228	SCO.	59 €
S628	D20 d20 Z03 L150 XOMX 09	20	3	150	20	55	0,373		65 €
S636	D20 d20 Z03 L200 XOMX 09	20	3	200	20	55	0,507		79 €
S632	D25 d25 Z03 L150 XOMX 09	25	3	150	25	55	0,352		65 €
S638	D20 d20 Z02 L120 XOMX 12	20	2	120	20	45	0,500		58 €
S640	D20 d20 Z02 L150 XOMX 12	20	2	150	20	55	0,439		65 €
S641	D20 d20 Z02 L200 XOMX 12	20	2	200	20	60	0,504	XOMX 1204	79 €
S642	D25 d25 Z03 L120 XOMX 12	25	3	120	25	45	0,443	SCO.	58 €
S643	D25 d25 Z03 L150 XOMX 12	25	3	150	25	55	0,574		65 €
S644	D25 d25 Z03 L200 XOMX 12	25	3	200	25	60	0,779		79 €
S645	D25 d25 Z03 L250 XOMX 12	25	3	250	25	70	0,856		106 €
S647	D32 d32 Z04 L120 XOMX 12	32	4	120	25	45	0,965		66 €
S648	D32 d32 Z04 L150 XOMX 12	32	4	150	32	55	0,937		76 €
S650	D40 d32 Z04 L150 XOMX 12	40	4	150	32	45	1,047		76 €

Code			
S623-S625	TC057-1 M1,8x4	T6	
S627-S632	TC060 M2,5x5,5	T8	
S638-S650	TC069 M3,5x8,5	T10	

Compatible with SCO insert. / Kompatibel für SCO WP

**APKT 0903**

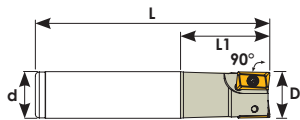
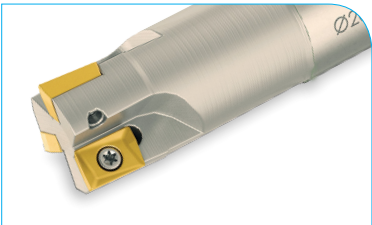
Order Code	Product Code	Dimensions (mm)					kg	Insert	Price
		D	Z	L	d	L1			
S204	D16 d16 Z02 L120 APKT 09	16	2	120	16	40	0,185		46 €
S206	D20 d20 Z03 L120 APKT 09	20	3	120	20	45	0,278	APKT 0903	58 €
S208	D25 d25 Z03 L120 APKT 09	25	3	120	25	45	0,453	WLTR.	58 €
S210	D16 d16 Z02 L150 APKT 09	16	2	150	16	50	0,237		59 €
S212	D20 d20 Z03 L150 APKT 09	20	3	150	20	45	0,354		65 €
S214	D25 d25 Z03 L150 APKT 09	25	3	150	25	45	0,590		65 €
S216	D16 d16 Z02 L200 APKT 09	16	2	200	16	60	0,340		69 €
S218	D20 d20 Z03 L200 APKT 09	20	3	200	20	60	0,502		79 €
S220	D25 d25 Z03 L200 APKT 09	25	3	200	25	60	0,765		79 €

Code			
S204,S210,S216	TC060 M2,5x5,5	T8	
S206-S208,S212-S214,S218-S220	TC063 M2,5x7		

Compatible with WLTR insert. / Kompatibel für WLTR WP

**ADMT 1204**

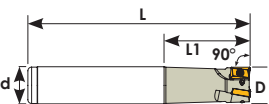
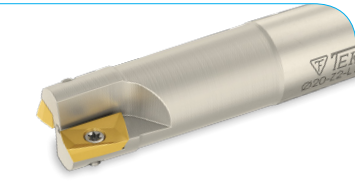
Order Code	Product Code	Dimensions (mm)					kg	Insert	Price
		D	Z	L	d	L1			
S498	D20 d20 Z02 L120 ADMT 12	20	2	120	20	40	0,275		58 €
S500	D20 d20 Z02 L150 ADMT 12	20	2	150	20	55	0,348	ADMT 1204	65 €
S501	D20 d20 Z02 L200 ADMT 12	20	2	200	20	60	0,498	WLTR.	69 €
S501-1	D25 d25 Z03 L120 ADMT 12	25	3	120	25	40	0,443		58 €
S502	D25 d25 Z03 L150 ADMT 12	25	3	150	25	60	0,550		65 €
S503	D30 d25 Z04 L150 ADMT 12	30	4	150	25	60	0,558		76 €
S504	D32 d32 Z04 L150 ADMT 12	32	4	150	32	50	0,932		76 €
S506	D40 d32 Z05 L150 ADMT 12	40	5	150	32	50	0,968		80 €

TC065 M3x7	T8	

Compatible with WLTR insert. / Kompatibel für WLTR WP

**ADMT 1606**

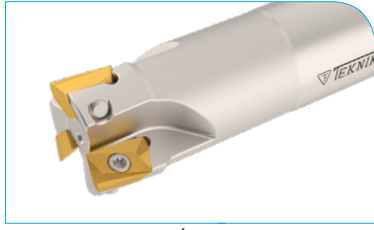

Order Code	Product Code	Dimensions (mm)						Insert	Price
		D	Z	L	d	L1	kg		
S460	D25 d25 Z02 L150 ADMT 16	25	2	150	25	60	0,534		65 €
S461	D25 d25 Z02 L200 ADMT 16	25	2	200	25	60	0,744	ADMT 1606	72 €
S463	D26 d25 Z02 L150 ADMT 16	26	2	150	25	60	0,545	WLTR.	65 €
S464	D26 d25 Z02 L200 ADMT 16	26	2	200	25	60	0,751		72 €
S466	D32 d32 Z03 L150 ADMT 16	32	3	150	32	60	0,784		69 €
S467	D32 d32 Z03 L200 ADMT 16	32	3	200	32	60	1,085		76 €
S469	D40 d32 Z04 L150 ADMT 16	40	4	150	32	60	0,927		74 €
S470	D40 d32 Z04 L200 ADMT 16	40	4	200	32	60	1,310		87 €



Compatible with WLTR insert. / Kompatibel für WLTR WP

**AXMT 0602 - APKT 0903**

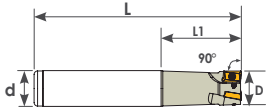
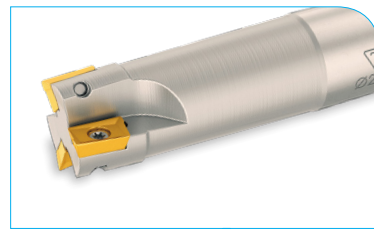

Order Code	Product Code	Dimensions (mm)						Insert	Price
		D	Z	L	d	L1	kg		
S010	D10 d10 Z02 L120 AXMT 06	10	2	120	10	30	0,085	AXMT 0602	64 €
S012	D12 d12 Z02 L120 AXMT 06	12	2	120	12	30	0,119	TGTC.	64 €
S014	D16 d16 Z02 L120 APKT 09	16	2	120	16	40	0,195		46 €
S016	D20 d20 Z03 L120 APKT 09	20	3	120	20	45	0,296		58 €
S018	D25 d25 Z03 L120 APKT 09	25	3	120	25	45	0,447		58 €
S020	D16 d16 Z02 L150 APKT 09	16	2	150	16	50	0,233	APKT 0903	59 €
S022	D20 d20 Z03 L150 APKT 09	20	3	150	20	60	0,370	TGTC.	65 €
S024	D25 d25 Z03 L150 APKT 09	25	3	150	25	60	0,583		65 €

Code



S010-S012

TC057-1M1,8x4

T6

S14-S030

TC060 M2,5x5,5

T8



Compatible with TGTC insert. / Kompatibel für TGTC WP

**APKT 1705**

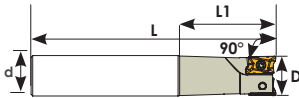
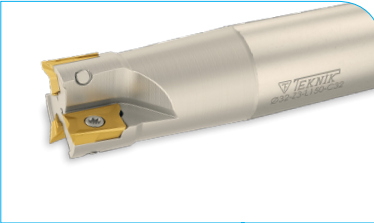

Order Code	Product Code	Dimensions (mm)						Insert	Price
		D	Z	L	d	L1	kg		
S660	D25 d25 Z02 L150 APKT 17	25	2	150	25	60	0,534		65 €
S660-1	D25 d25 Z02 L200 APKT 17	25	2	200	25	60	0,763	APKT 1705	79 €
S662	D32 d32 Z03 L150 APKT 17	32	3	150	32	60	0,850	TGTC.	69 €
S662-1	D32 d32 Z03 L200 APKT 17	32	3	200	32	60	1,236		79 €
S664	D40 d32 Z04 L150 APKT 17	40	4	150	32	60	0,850		74 €



Compatible with TGTC insert. / Kompatibel für TGTC WP

**APKT 1003**

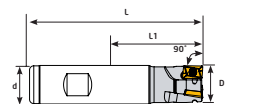

Order Code	Product Code	Dimensions (mm)						Insert	Price
		D	Z	L	d	L1	kg		
S766	D16 d16 Z02 L085 APKT 10	16	2	85	16	26	0,123	APKT 1003	50 €
S767	D20 d20 Z03 L090 APKT 10	20	3	90	20	28	0,209	PLBT	57 €
S768	D25 d20 Z04 L150 APKT 10	25	4	150	20	26	0,388		79 €

Yedek Part



Insert

Code

TC060 M2,5x5,5

T8

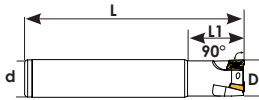

Compatible with PLBT insert. / Kompatibel für PLBT WP

**BDMT 11T3**

Order Code	Product Code	Dimensions (mm)							Insert	Price
		D	Z	L	d	L1				
S565	D16 d16 Z02 L150 BDMT 11	16	2	150	16	45	0,232		59 €	
S566	D18 d16 Z02 L150 BDMT 11	18	2	150	16	44	0,240	BDMT 11T3	59 €	
S567	D20 d20 Z03 L150 BDMT 11	20	3	150	20	50	0,351	KYCRA.	65 €	
S569	D25 d25 Z03 L150 BDMT 11	25	3	150	25	50	0,563		65 €	
S570	D25 d25 Z03 L200 BDMT 11	25	3	200	25	60	0,764		79 €	
S572	D32 d32 Z04 L150 BDMT 11	32	4	150	32	50	0,961		91 €	
S574	D32 d32 Z04 L200 BDMT 11	32	4	200	32	60	1,294		91 €	

TC060 M2,5x5,5      T8     

Compatible with KYCRA insert. / Kompatibel für KYCRA WP

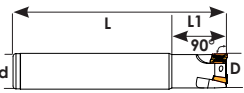
**BDMT 1704**

Order Code	Product Code	Dimensions (mm)							Insert	Price
		D	Z	L	d	L1				
S578	D25 d25 Z02 L120 BDMT 17	25	2	120	25	35	0,432		50 €	
S579	D25 d25 Z02 L150 BDMT 17	25	2	150	25	50	0,548	BDMT 1704	65 €	
S581	D32 d25 Z03 L120 BDMT 17	32	3	120	25	40	0,480	KYCRA.	53 €	
S582	D32 d32 Z03 L150 BDMT 17	32	3	150	32	60	0,895		69 €	
S584	D40 d32 Z04 L120 BDMT 17	40	4	120	32	40	0,790		63 €	
S585	D40 d32 Z04 L150 BDMT 17	40	4	150	32	40	0,985		74 €	

**Code**      TC073 M4x8,5      T15     

S578,S579      TC074 M4x10  
 S581-S585

Compatible with KYCRA insert. / Kompatibel für KYCRA WP

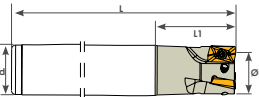
**BOMT 1304**

Order Code	Product Code	Dimensions (mm)							Insert	Price
		D	Z	L	d	L1				
S850	D20 d20 Z02 L120 BOMT 13	20	2	120	20	40	0,289		61 €	
S851	D20 d20 Z02 L150 BOMT 13	20	2	150	20	40	0,356	BOMT 1304	66 €	
S852	D25 d25 Z03 L120 BOMT 13	25	3	120	25	40	0,451	INGRSL.	61 €	
S853	D25 d25 Z03 L150 BOMT 13	25	3	150	25	40	0,556		66 €	

TC069 M3,5x8,5      T10     

Compatible with INGRSLL insert. / Kompatibel für INGRSLL WP

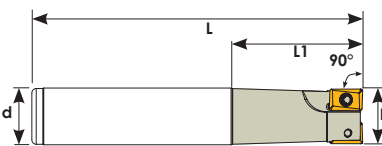
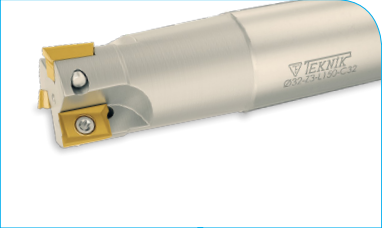
**ADKT 1505**

Order Code	Product Code	Dimensions (mm)							Insert	Price
		D	Z	L	d	L1				
S304	D25 d25 Z02 L120 ADKT 15	25	2	120	25	45	0,434		50 €	
S306	D30 d25 Z03 L120 ADKT 15	30	3	120	25	45	0,466		53 €	
S307	D32 d25 Z03 L120 ADKT 15	32	3	120	25	45	0,477		53 €	
S308	D35 d25 Z03 L120 ADKT 15	35	3	120	25	45	0,500		53 €	
S310	D40 d32 Z04 L120 ADKT 15	40	4	120	32	45	0,759		63 €	
S312	D25 d25 Z02 L150 ADKT 15	25	2	150	25	60	0,550	ADKT 1505	65 €	
S314	D30 d25 Z03 L150 ADKT 15	30	3	150	25	50	0,596	ISCR.	69 €	
S315	D32 d32 Z03 L150 ADKT 15	32	3	150	32	60	0,887		69 €	
S316	D35 d32 Z03 L150 ADKT 15	35	3	150	32	50	0,920		69 €	
S318	D25 d25 Z02 L200 ADKT 15	25	2	200	25	55	0,711		72 €	
S319	D30 d25 Z03 L200 ADKT 15	30	3	200	25	50	0,783		76 €	
S320	D32 d32 Z03 L200 ADKT 15	32	3	200	32	60	1,198		76 €	
S321	D35 d32 Z03 L200 ADKT 15	35	3	200	32	50	1,252		76 €	
S322	D40 d32 Z04 L200 ADKT 15	40	4	200	32	60	1,272		87 €	

TC074 M4x10      T15     

Compatible with ISCR insert. / Kompatibel für ISCR WP

### ADMX 0702

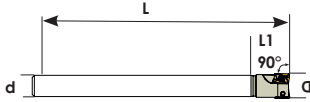
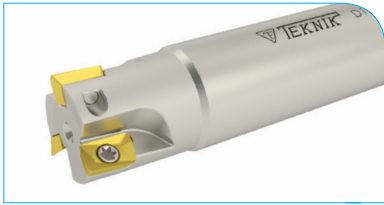

Order Code	Product Code	Dimensions (mm)						Insert	Price
		D	Z	L	d	L1			
S751	D10 d10 Z02 L080 ADMX 07	10	2	80	10	16	0,062		66 €
S759	D16 d16 Z03 L160 ADMX 07	16	3	160	16	18	0,205	ADMX 0702	88 €
S760	D20 d20 Z04 L125 ADMX 07	20	4	125	20	17	0,293	PRMT.	99 €
S761	D20 d20 Z05 L125 ADMX 07	20	5	125	20	17	0,300		116 €

TC058 M2x4,2     T6    

Compatible with PRMT insert. / Kompatibel für PRMT WP

### 3PKT 1004

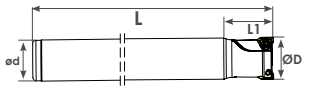

Order Code	Product Code	Dimensions (mm)						Insert	Price
		D	Z	L	d	L1			
S485	D21 d20 Z02 L200 3PKT 10	21	2	200	20	30	1,259	3PKT 1004	80 €
S486	D26 d25 Z02 L200 3PKT 10	26	2	200	25	30	0,773	TGTC.	80 €
S487	D33 d32 Z03 L200 3PKT 10	33	3	200	32	40	0,495		86 €

TC093 M2,5x7     T8    

Compatible with TGTC insert. / Kompatibel für TGTC WP

### 4NKT 06

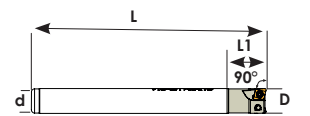
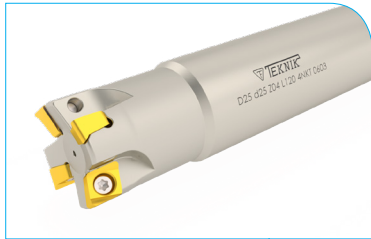

Order Code	Product Code	Dimensions (mm)						Insert	Price
		D	Z	L	d	L1			
S471	D16 d16 Z02 L120 4NKT 06	16	2	120	16	25	0,200		72 €
S471-1	D16 d16 Z02 L150 4NKT 06	16	2	150	16	25	0,250	4NKT 06	80 €
S472	D17 d16 Z02 L150 4NKT 06	17	2	150	16	22	0,241	TGTC.	80 €
S473	D20 d20 Z03 L120 4NKT 06	20	3	120	20	25	0,306		75 €
S474	D21 d20 Z03 L200 4NKT 06	21	3	200	20	25	0,524		86 €
S475	D25 d25 Z04 L120 4NKT 06	25	4	120	25	30	0,474		88 €
S475-1	D25 d25 Z04 L200 4NKT 06	25	3	200	25	30	0,806		86 €
S476	D26 d25 Z03 L200 4NKT 06	26	3	200	25	30	0,815		86 €
S477	D33 d32 Z04 L200 4NKT 06	33	4	200	32	35	1,327		92 €
S477-1	D33 d32 Z04 L220 4NKT 06	33	4	220	32	35	1,462		92 €
S477-2	D40 d32 Z05 L200 4NKT 06	40	5	200	32	40	1,395		99 €

TC064 M3x6,5     T8    

Compatible with TGTC insert. / Kompatibel für TGTC WP

### XNKT 0604

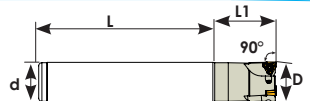

Order Code	Product Code	Dimensions (mm)						Insert	Price
		D	Z	L	d	L1			
S834	D20 d20 Z02 L150 XNKT 06	20	2	150	20	40	0,365		80 €
S836	D21 d20 Z02 L150 XNKT 06	21	2	150	20	40	0,372	XNKT 0604	80 €
S838	D25 d25 Z03 L150 XNKT 06	25	3	150	25	40	0,572	KRLY.	86 €
S840	D26 d25 Z03 L150 XNKT 06	26	3	150	25	40	0,572		86 €
S841	D32 d32 Z04 L150 XNKT 06	32	4	150	32	40	0,941		86 €
S842	D40 d32 Z05 L130 XNKT 06	40	5	130	32	45	0,865		84 €

TC065-1 M3x7     T8    

Compatible with KRLY insert. / Kompatibel für KRLY WP

### XNKT 0805

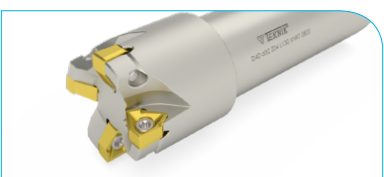

Order Code	Product Code	Dimensions (mm)						Insert	Price
		D	Z	L	d	L1			
S843	D32 d32 Z03 L125 XNKT 08	32	3	125	32	37	0,817	XNKT 0805	69 €
S844	D40 d32 Z04 L130 XNKT 08	40	4	130	32	40	0,986	KRLY	74 €

TC072 M4x10     T15    

Compatible with KRLY insert. / Kompatibel für KRLY WP

### ANKX 1205

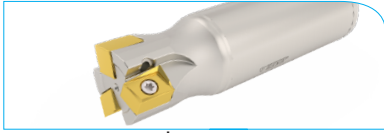

Order Code	Product Code	Dimensions (mm)						Insert	Price
		D	Z	L	d	L1			
S695	D32 d32 Z03 L120 ANKX 12	32	3	120	32	40	0,700	ANKX 1205 ISCR.	72 €

TC074 M4x10      T15     

Compatible with ISCR insert. / Kompatibel für ISCR WP

### ANHX 1004 - 1206

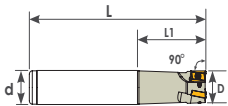

Order Code	Product Code	Dimensions (mm)						Insert	Price
		D	Z	L	d	L1			
S775	D16 d16 Z02 L090 ANHX 10	16	2	90	16	25	0,140		59 €
S776	D20 d20 Z02 L100 ANHX 10	20	2	100	20	30	0,247	ANHX 1004	59 €
S762	D25 d25 Z03 L115 ANHX 10	25	3	115	25	35	0,432	PLBT	73 €
S763	D32 d32 Z03 L125 ANHX 10	32	3	125	32	40	0,783		69 €
S782	D16 d16 Z02 L160 ANHX 10	16	2	160	16	25	0,036		83 €
S783	D20 d20 Z03 L160 ANHX 10	20	3	160	20	30	0,058		92 €
S784	D25 d25 Z03 L180 ANHX 10	25	3	180	25	35	0,099		92 €
S785	D32 d32 Z04 L150 ANHX 10	32	4	150	32	40	0,136		102 €
S764	D25 d25 Z02 L110 ANHX 12	25	2	110	25	35	0,405	ANHX 1206	59 €
S765	D32 d32 Z03 L150 ANHX 12	32	3	150	32	35	0,922	PLBT	73 €

**Code**      TC065 M3x7      T8     

S775-S785      TC069 M3,5x8,5      T10

Compatible with PLBT insert. / Kompatibel für PLBT WP

### LNGU 15T6

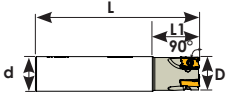

Order Code	Product Code	Dimensions (mm)						Insert	Price
		D	Z	L	d	L1			
S950	D25 d25 Z02 L150 LNGU 15	25	2	150	25	45	0,547	LNGU 15T6	83 €
S951	D32 d32 Z03 L150 LNGU 15	32	3	150	32	45	0,884	KNNMTL.	91 €

TC074 M4x10      T15     

Compatible with KNNMTL insert. / Kompatibel für KNNMTL WP

### LNMX 1006

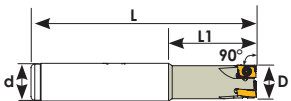

Order Code	Product Code	Dimensions (mm)						Insert	Price
		D	Z	L	d	L1			
LN096	D16 d16 Z01 L090 LNMX 10	16	1	90	16	25	0,140		52 €
LN097	D22 d20 Z02 L100 LNMX 10	22	2	100	20	-	0,263	LNMX 1006	57 €
LN098	D24 d25 Z03 L100 LNMX 10	24	3	100	25	15	0,389	KRLY.	69 €
LN099	D20 d20 Z02 L120 LNMX 10	20	2	120	20	25	0,292		57 €
LN100	D20 d20 Z03 L120 LNMX 10	20	3	120	20	25	0,285		69 €
LN102	D25 d25 Z03 L120 LNMX 10	25	3	120	25	40	0,453		69 €
LN103	D32 d32 Z04 L125 LNMX 10	32	4	125	32	40	0,706		79 €
LN104	D40 d32 Z05 L130 LNMX 10	40	5	130	32	42	0,857		92 €

TC065 M3x7      T8     

Compatible with KRLY insert. / Kompatibel für KRLY WP

### LNMX 1510

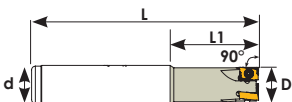
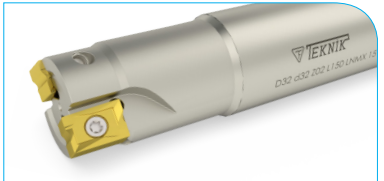

Order Code	Product Code	Dimensions (mm)						Insert	Price
		D	Z	L	d	L1			
S361	D32 d32 Z02 L150 LNMX 15	32	2	150	32	50	0,885	LNMX 1510	83 €
S362	D40 d32 Z03 L150 LNMX 15	40	3	150	32	50	0,966	KRLY.	91 €

TC076 M4x12,5      T15     

Compatible with KRLY insert. / Kompatibel für KRLY WP



### WNGX 0403

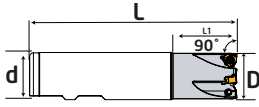

Order Code	Product Code	Dimensions (mm)						Insert	Price
		D	Z	L	d	L1	kg		
S944	D20 d20 Z03 L110 WNGX 04	20	3	110	20	35	0,246	WNGX 0403	69 €
S945	D25 d25 Z04 L110 WNGX 04	25	4	110	25	35	0,380	KRLY	79 €
S946	D32 d32 Z05 L110 WNGX 04	32	5	110	32	35	0,642		91 €



TC060 M2,5x5,5



T8



Compatible with KRLY insert. / Kompatibel für KRLY WP

### XNEX 0403

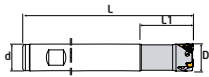
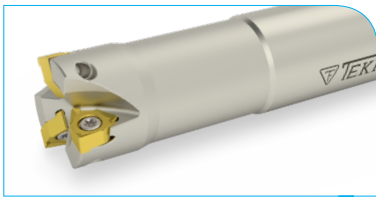

Order Code	Product Code	Dimensions (mm)						Insert	Price
		D	Z	L	d	L1	kg		
S195	D20 d20 Z03 L150 XNEX 04	20	3	150	20	40	0,344	XNEX 0403	72 €
S196	D21 d20 Z03 L150 XNEX 04	21	3	150	20	40	0,348	SCO	72 €
S198	D26 d25 Z04 L150 XNEX 04	26	4	150	25	40	0,535		96 €



TC061 M2,5x7



T8



Compatible with SCO insert. / Kompatibel für SCO WP

### WNGX 0806

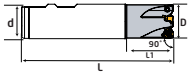
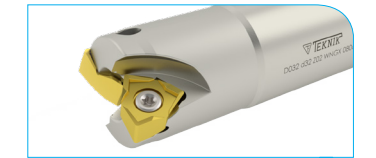

Order Code	Product Code	Dimensions (mm)						Insert	Price
		D	Z	L	d	L1	kg		
S949	D40 d32 Z03 L120 WNGX 08	40	3	120	32	40	0,784	WNGX 0806 KRLY	79 €



TC083 M5x12



T20



Compatible with KRLY insert. / Kompatibel für KRLY WP

### LNMT 0804

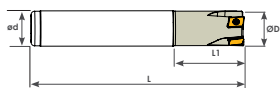

Order Code	Product Code	Dimensions (mm)						Insert	Price
		D	Z	L	d	L1	kg		
S298	D16 d16 Z02 L120 LNMT 08	16	2	120	16	40	0,206		57 €
S299	D20 d20 Z03 L120 LNMT 08	20	3	120	20	40	0,313	LNMT 0804	69 €
S300	D25 d25 Z04 L120 LNMT 08	25	4	120	25	40	0,477	ISCR.	77 €
S300-1	D32 d32 Z05 L120 LNMT 08	32	5	120	32	40	0,775		87 €
S301	D16 d16 Z02 L150 LNMT 08	16	2	150	16	40	0,256		70 €
S302	D20 d20 Z03 L150 LNMT 08	20	3	150	20	40	0,391		80 €
S303	D25 d25 Z04 L150 LNMT 08	25	4	150	25	40	0,601		88 €
S303-1	D32 d32 Z05 L150 LNMT 08	32	5	150	32	40	0,978		97 €



TC061 M2,5x6,5



T8



Compatible with ISCR insert. / Kompatibel für ISCR WP

### WNMU 0403

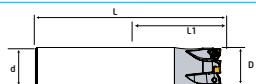
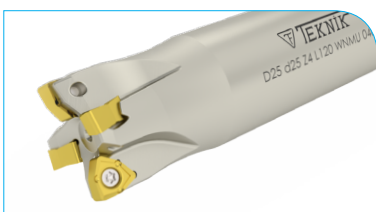

Order Code	Product Code	Dimensions (mm)						Insert	Price
		D	Z	L	d	L1	kg		
S457	D20 d20 Z03 L120 WNMU 04	20	3	120	20	25	0,290	WNMU 0403	70 €
S458	D25 d25 Z04 L120 WNMU 04	25	4	120	25	30	0,466	ISCR	80 €
S459	D32 d32 Z04 L120 WNMU 04	32	4	120	32	35	0,776		81 €



TC060 M2,5x5,5



T8



Compatible with ISCR insert. / Kompatibel für ISCR WP

### LOEX 0804

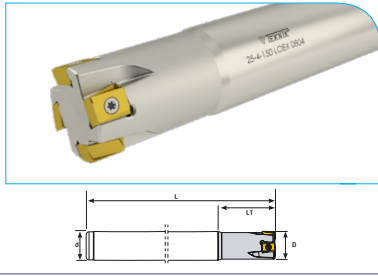

Order Code	Product Code	Dimensions (mm)						Insert	Price
		D	Z	L	d	L1			
S295	D20 d20 Z03 L150 LOEX 08	20	3	150	20	40	0,384	LOEX 0804	80 €
S296	D25 d25 Z04 L150 LOEX 08	25	4	150	25	40	0,604	SCO	88 €

Compatible with SCO insert. / Kompatibel für SCO WP

### LNHU 0904

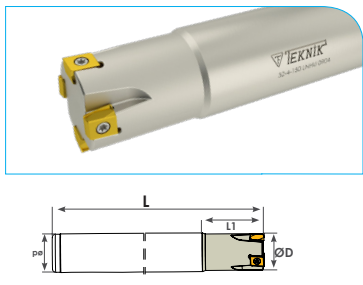

Order Code	Product Code	Dimensions (mm)						Insert	Price
		D	Z	L	d	L1			
S328	D25 d25 Z03 L150 LNHU 09	25	3	150	25	40	0,599	LNHU 0904	80 €
S329	D32 d32 Z04 L150 LNHU 09	32	4	150	32	40	0,972	WLTR.	88 €

Compatible with WLTR insert. / Kompatibel für WLTR WP

### LNMX 0603

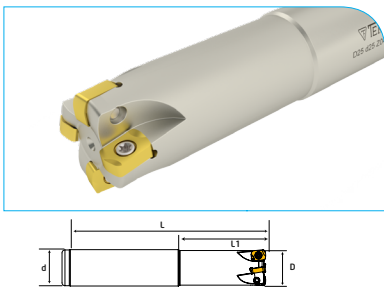

Order Code	Product Code	Dimensions (mm)						Insert	Price
		D	Z	L	d	L1			
S284	D16 d16 Z02 L110 LNMX 06	16	2	110	16	30	0,172		66 €
S285	D20 d20 Z03 L130 LNMX 06	20	3	130	20	50	0,325	LNMX 0603	78 €
S286	D25 d25 Z04 L140 LNMX 06	25	4	140	25	60	0,552	KRLY	87 €
S287	D32 d32 Z05 L150 LNMX 06	32	5	150	32	70	1,516		96 €

Compatible with KRLY insert. / Kompatibel für KRLY WP

### BLMP 0603

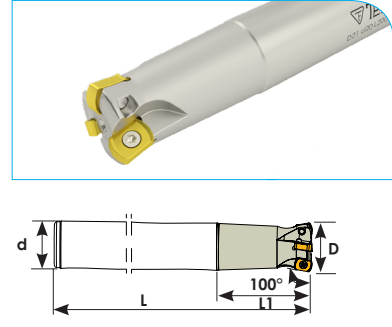

Order Code	Product Code	Dimensions (mm)						Insert	Price
		D	Z	L	d	L1			
S479	D16 d16 Z02 L150 BLMP 06	16	2	150	16	40	0,235		83 €
S478	D17 d16 Z02 L150 BLMP 06	17	2	150	16	40	0,244	BLMP 0603	80 €
S481	D20 d20 Z03 L150 BLMP 06	20	3	150	20	40	0,335	TGTC.	87 €
S483	D25 d20 Z04 L150 BLMP 06	25	4	150	20	30	0,280		89 €
S480	D21 d20 Z03 L200 BLMP 06	21	3	200	20	40	0,520		91 €
S482	D26 d25 Z04 L200 BLMP 06	26	4	200	25	40	0,771		97 €



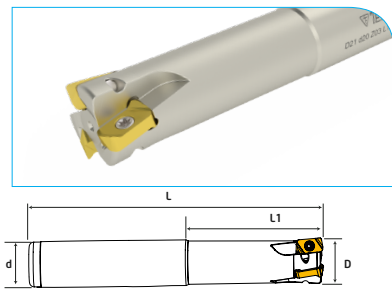

Compatible with TGTC insert. / Kompatibel für TGTC WP

### LOGU 0303



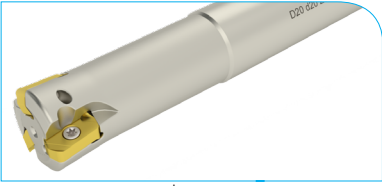
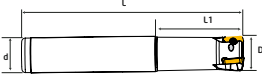



Order Code	Product Code	Dimensions (mm)						Insert	Price
		D	Z	L	d	L1			
S677	D16 d16 Z02 L150 LOGU 03	16	2	150	16	50	0,219		68 €
S678	D20 d20 Z03 L150 LOGU 03	20	3	150	20	60	0,356	LOGU 0303	80 €
S679	D21 d20 Z03 L150 LOGU 03	21	3	150	20	60	0,365	KYCR	80 €
S680	D25 d25 Z04 L150 LOGU 03	25	4	150	25	60	0,579		88 €



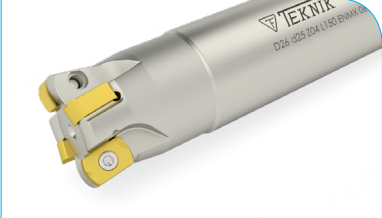
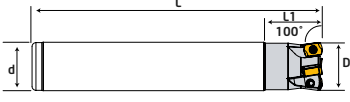

Compatible with KYCRA insert. / Kompatibel für KYCRA WP

LNMU 0303	Order Code	Product Code	Dimensions (mm)						Insert	Price
			D	Z	L	d	L1			
	S671	D16 d16 Z02 L150 LNMU 03	16	2	150	16	50	0,233		68 €
	S672	D17 d16 Z02 L150 LNMU 03	17	2	150	16	40	0,241	LNMU 0303	68 €
	S673	D20 d20 Z03 L150 LNMU 03	20	3	150	20	50	0,381	TNGLY - OKE	80 €
	S674	D21 d20 Z03 L150 LNMU 03	21	3	150	20	50	0,389		80 €
	S675	D25 d25 Z04 L150 LNMU 03	25	4	150	25	60	0,589		88 €
	  									



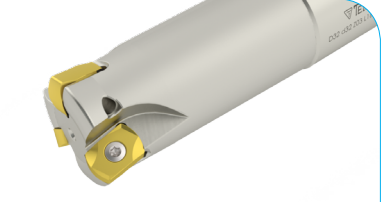
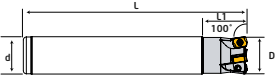

Compatible with TNGLY - OKE insert. / Kompatibel für TNGLY - OKE WP

ENMX 0604	Order Code	Product Code	Dimensions (mm)						Insert	Price
			D	Z	L	d	L1			
	S105	D16 d16 Z02 L100 ENMX 06	16	2	100	16	30	0,146		57 €
	S106	D16 d16 Z02 L150 ENMX 06	16	2	150	16	50	0,228	ENMX 0604	63 €
	S107	D17 d16 Z02 L150 ENMX 06	17	2	150	16	20	0,242	YG1	63 €
	S108	D20 d20 Z03 L130 ENMX 06	20	3	130	20	50	0,316		69 €
	S109	D20 d20 Z03 L160 ENMX 06	20	3	160	20	80	0,382		76 €
	S110	D21 d20 Z03 L150 ENMX 06	21	3	150	20	20	0,391		76 €
	S111	D25 d25 Z04 L140 ENMX 06	25	4	140	25	60	0,538		79 €
	S112	D25 d25 Z04 L180 ENMX 06	25	4	180	25	80	0,696		85 €
	S113	D26 d25 Z04 L150 ENMX 06	26	4	150	25	30	0,612		85 €
	S114	D32 d32 Z05 L150 ENMX 06	32	5	150	32	70	0,963		90 €
	S115	D32 d32 Z05 L200 ENMX 06	32	5	200	32	70	0,963		96 €
	  									

Compatible with YG1 insert. / Kompatibel für YG1 WP

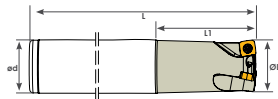
ENMX 0905	Order Code	Product Code	Dimensions (mm)						Insert	Price
			D	Z	L	d	L1			
	S934	D25 d25 Z02 L150 ENMX 09	25	2	150	25	70	0,576		63 €
	S935	D32 d32 Z03 L160 ENMX 09	32	3	160	32	70	1,015	ENMX 0905	76 €
	S936	D40 d32 Z05 L180 ENMX 09	40	5	180	32	40	1,308	YG1	96 €
	  									

Compatible with YG1 insert. / Kompatibel für YG1 WP

SDMT 09T3	Order Code	Product Code	Dimensions (mm)						Insert	Price
			D	Z	L	d	L1			
	S395	D25 d25 Z02 L150 SDMT 09	25	2	150	25	60	0,573	SDMT 09T3	65 €
	S396	D32 d32 Z03 L150 SDMT 09	32	3	150	32	60	0,934	ZCC	75 €
	  									

Compatible with ZCC insert. / Kompatibel für ZCC WP

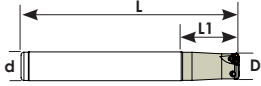
**WNMX 0603**

Order Code	Product Code	Dimensions (mm)							Insert	Price
		D	Z	L	d	L1				
S898	D16 d16 Z02 L150 WNMX 06	16	2	150	16	40	0,241		80 €	
S899	D20 d20 Z02 L150 WNMX 06	20	2	150	20	40	0,378	WNMX 0603	80 €	
S903	D17 d16 Z02 L150 WNMX 06	17	2	150	16	40	0,240	KRLY.	80 €	
S904	D21 d20 Z02 L150 WNMX 06	21	2	150	20	40	0,379		80 €	
S905	D25 d25 Z03 L150 WNMX 06	25	3	150	25	60	0,578		88 €	
S906	D26 d25 Z04 L150 WNMX 06	26	4	150	25	60	0,582		96 €	

TC061 M2,5x6,5      T8     

Compatible with KRLY insert. / Kompatibel für KRLY WP

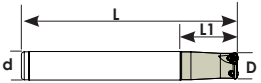
**WNMX 09T3**

Order Code	Product Code	Dimensions (mm)							Insert	Price
		D	Z	L	d	L1				
S802	D25 d25 Z02 L150 WNMX 09	25	2	150	25	60	0,563		80 €	
S803	D26 d25 Z02 L140 WNMX 09	26	2	140	25	60	0,477		80 €	
S804	D30 d25 Z03 L150 WNMX 09	30	3	150	25	60	0,590	WNMX 09T3	88 €	
S805	D32 d32 Z03 L150 WNMX 09	32	3	150	32	70	0,841	KRLY.	89 €	
S806	D33 d32 Z03 L150 WNMX 09	33	3	150	32	70	0,854		89 €	
S807	D40 d32 Z04 L150 WNMX 09	40	4	150	32	60	0,974		95 €	

TC065 M3x7      T8     

Compatible with KRLY insert. / Kompatibel für KRLY WP

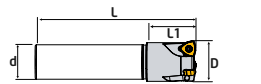
**WNMX 1305**

Order Code	Product Code	Dimensions (mm)							Insert	Price
		D	Z	L	d	L1				
S800	D32 d32 Z02 L120 WNMX 13	32	2	120	32	70	0,933	WNMX 1305	79 €	
S801	D40 d32 Z03 L150 WNMX 13	40	3	150	32	50	1,069	KRLY	89 €	

TC074 M4x10      T15     

Compatible with KRLY insert. / Kompatibel für KRLY WP

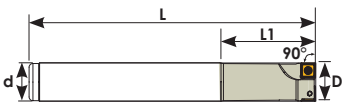
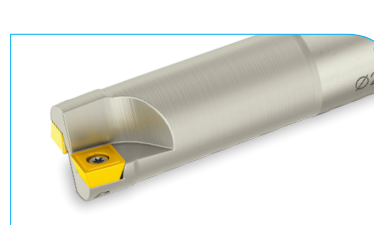

**SPMG 0502 - 0602-07T3 0904**

Order Code	Product Code	Dimensions (mm)							Insert	Price
		D	Z	L	d	L1				
S810	D013 d14 Z02 L120 SPMG 05	13	2	120	14	40	0,147	SPMG 0502	53 €	
S812	D13,5 d14 Z02 L120 SPMG 05	13,5	2	120	14	40	0,149	TGTC	53 €	
S814	D014 d14 Z02 L120 SPMG 06	14	2	120	14	40	0,148	SPMG 0602	53 €	
S818	D015 d16 Z02 L120 SPMG 06	15	2	120	16	40	0,186	TGTC.	53 €	
S822	D016 d16 Z02 L120 SPMG 06	16	2	120	16	40	0,194		53 €	
S824	D020 d20 Z02 L150 SPMG 07	20	2	150	20	50	0,198	SPMG 07T3	65 €	
S826	D20,5 d20 Z02 L120 SPMG 07	20,5	2	120	20	50	0,290	TGTC.	57 €	
S828	D025 d25 Z02 L150 SPMG 09	25	2	150	25	50	0,567	SPMG 0904	68 €	
S830	D032 d32 Z03 L150 SPMG 09	32	3	150	32	40	0,908	TGTC	78 €	

Code			
S810-S812	TC058 M2x4,2	T6	
S814-S822	TC059 M2,2x5	T7	
S824-S826	TC063 M2,5x7	T8	
S828-S830	TC067 M3,5x8,5	T15	

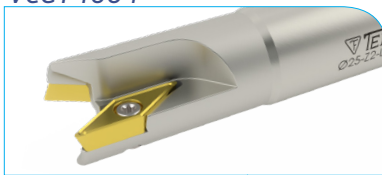

Compatible with TGTC insert. / Kompatibel für TGTC WP

VCGT 1604	Order Code	Product Code	Dimensions (mm)						Insert	Price
			D	Z	L	d	L1	kg		
	S710	D25 d25 Z02 L150 VCGT 16	25	2	150	25	50	0,518		67 €
	S712	D32 d32 Z02 L150 VCGT 16	32	2	150	32	60	0,852	VCGT 1604	72 €
	S714	D40 d32 Z03 L150 VCGT 16	40	3	150	32	60	0,951	ISO.	76 €
	S718	D25 d25 Z02 L200 VCGT 16	25	2	200	25	60	0,730		74 €
	S720	D32 d32 Z02 L200 VCGT 16	32	2	200	32	60	1,225		77 €
	S724	D25 d25 Z02 L250 VCGT 16	25	2	250	25	60	0,920		91 €
	S726	D32 d32 Z02 L250 VCGT 16	32	2	250	32	60	1,250		98 €

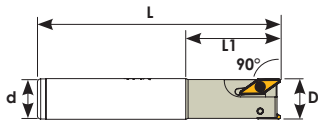
 TC074 M4x10  T15 



F75° APXT 1003	Order Code	Product Code	Dimensions (mm)						Insert	Price
			D	Z	L	d	L1	kg		
	S344	D32 d25 Z03 L100 APXT 10	32	3	100	25	35	0,413		57 €
	S346	D40 d25 Z04 L100 APXT 10	40	4	100	25	35	0,494	APXT 1003	61 €
	S348	D45 d25 Z04 L100 APXT 10	45	4	100	25	35	0,535	KRLY.	61 €
	S350	D50 d25 Z05 L100 APXT 10	50	5	100	25	35	0,583		73 €

 TC060 M2,5x5,5  T8 

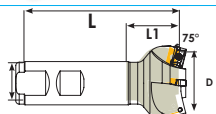

Compatible with KRLY insert. / Kompatibel für KRLY WP

Küre Insertlu Freze	Order Code	Product Code	Dimensions (mm)					Insert	Price
			D	L	d	L1	kg		
	S370	D08 d10 L130 P32-08	8	130	10	36	0,092	P32 08 WLTR.	61 €
	S372	D10 d12 L130 P32-10	10	130	12	46	0,118	P32 10 WLTR.	61 €
	S374	D12 d12 L150 P32-12	12	150	12	46	0,142	P32 12 WLTR.	66 €
	S376	D16 d16 L175 P32-16	16	175	16	46	0,270	P32 16 WLTR.	75 €
	S378	D20 d20 L200 P32-20	20	200	20	56	0,505	P32 20 WLTR.	78 €
	S380	D25 d25 L200 P32-25	25	200	25	66	0,745	P32 25 WLTR.	80 €
	S381	D30 d32 L200 P32-30	30	200	32	66	1,148	P32 30 WLTR.	84 €
	S382	D32 d32 L200 P32-32	32	200	32	66	1,150	P32 32 WLTR.	84 €

**Code**

S370	TC170 M3	T8
S372	TC172 M4	T15
S374	TC174 M5	T20
S376	TC176 M5	T20
S378	TC178 M5	T20
S380	TC181 M6	3 Allen
S381-S382	TC184 M8	4 Allen



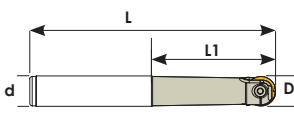

Compatible with WLTR insert. / Kompatibel für WLTR WP

RDMT 1003-12T3	Order Code	Product Code	Dimensions (mm)						Insert	Price
			D	Z	L	d	L1	kg		
	S771	D20 d20 Z02 L160 RDMT 10	20	2	160	20	60	0,359	RDMT 1003	77 €
	S772	D20 d25 Z02 L220 RDMT 10	20	2	220	25	120	0,658	PLBT	86 €
	S773	D25 d25 Z02 L220 RDMT 12	25	2	220	25	120	0,741	RDMT 12T3	86 €
	S774	D25 d32 Z02 L230 RDMT 12	25	2	230	32	130	1,099	PLBT	90 €

**Code**

S771-S772	TC071 M3,5x7	T15
S773-S774	TC067 M3,5x8,5	



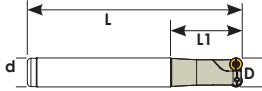

Compatible with PLBT insert. / Kompatibel für PLBT WP

### RDMW 0501

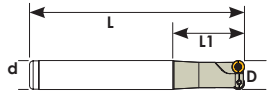
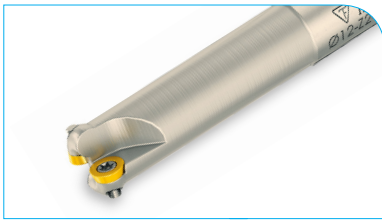

Order Code	Product Code	Dimensions (mm)							Insert	Price
		D	Z	L	d	L1				
R080	D08 d10 Z01 L080 RDMW 05	8	1	80	10	27	0,053		58 €	
R082	D10 d12 Z02 L080 RDMW 05	10	2	80	12	34	0,076	RDMW 0501	58 €	
R083	D10 d12 Z02 L100 RDMW 05	10	2	100	12	40	0,085	TGTC.	58 €	
R084	D10 d12 Z02 L120 RDMW 05	10	2	120	12	45	0,111		58 €	
R086	D12 d12 Z02 L100 RDMW 05	12	2	100	12	40	0,099		58 €	
R088	D12 d12 Z02 L120 RDMW 05	12	2	120	12	45	0,118		58 €	



Compatible with TGTC insert. / Kompatibel für TGTC WP

### RDMW 0702

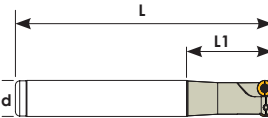
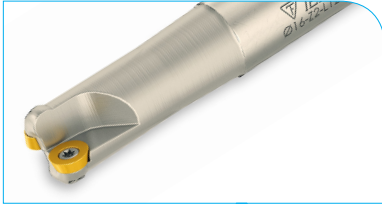

Order Code	Product Code	Dimensions (mm)							Insert	Price
		D	Z	L	d	L1				
R136	D15 d16 Z02 L120 RDMW 07	15	2	120	16	40	0,187		58 €	
R138	D16 d16 Z02 L120 RDMW 07	16	2	120	16	40	0,148	RDMW 0702	58 €	
R142	D20 d20 Z03 L120 RDMW 07	20	3	120	20	45	0,278	TGTC.	64 €	
R143	D15 d16 Z02 L150 RDMW 07	15	2	150	16	50	0,228		66 €	
R144	D16 d16 Z02 L150 RDMW 07	16	2	150	16	60	0,230		66 €	
R148	D20 d20 Z03 L150 RDMW 07	20	3	150	20	60	0,354		69 €	



Compatible with TGTC insert. / Kompatibel für TGTC WP

### RPMW 0803

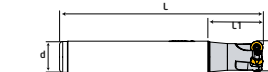
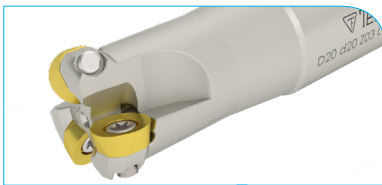

Order Code	Product Code	Dimensions (mm)							Insert	Price
		D	Z	L	d	L1				
R310	D16 d16 Z02 L130 RPMW 08	16	2	130	16	35	0,198		65 €	
R311	D18 d16 Z02 L150 RPMW 08	18	2	150	16	35	0,240	RPMW 0803	75 €	
R312	D20 d20 Z03 L130 RPMW 08	20	3	130	20	35	0,316	KRLY	76 €	
R313	D25 d25 Z04 L150 RPMW 08	25	4	150	25	35	0,591		84 €	



Compatible with KRLY insert. / Kompatibel für KRLY WP

### RPMW 10T3

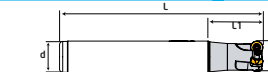
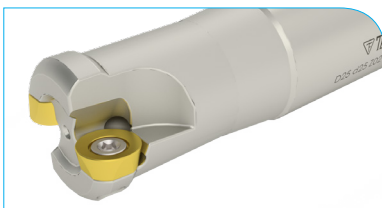

Order Code	Product Code	Dimensions (mm)							Insert	Price
		D	Z	L	d	L1				
R316	D20 d20 Z02 L120 RPMW 10	20	2	120	20	40	0,282		65 €	
R317	D25 d25 Z02 L120 RPMW 10	25	2	120	25	40	0,447	RPMW 10T3	65 €	
R318	D25 d25 Z02 L160 RPMW 10	25	2	160	25	60	0,617	KRLY	75 €	
R319	D32 d32 Z04 L125 RPMW 10	32	4	125	32	40	0,792		78 €	
R320	D32 d25 Z04 L200 RPMW 10	32	4	200	25	60	0,891		95 €	
R321	D40 d32 Z04 L150 RPMW 10	40	4	150	32	35	1,071		95 €	



Compatible with KRLY insert. / Kompatibel für KRLY WP

### RPMW 1204

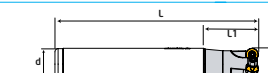
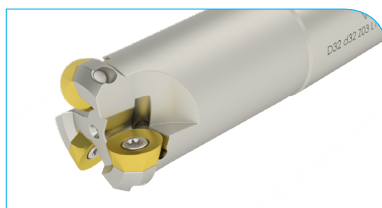

Order Code	Product Code	Dimensions (mm)							Insert	Price
		D	Z	L	d	L1				
R325	D25 d25 Z02 L160 RPMW 12	25	2	160	25	60	0,607		75 €	
R326	D32 d32 Z03 L160 RPMW 12	32	3	160	32	60	1,017	RPMW 1204	79 €	
R327	D40 d32 Z04 L150 RPMW 12	40	4	150	32	35	1,056	KRLY	84 €	



Compatible with KRLY insert. / Kompatibel für KRLY WP

**RDMT 1003**

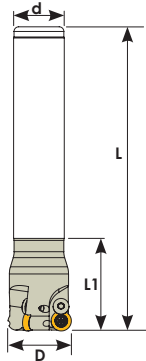
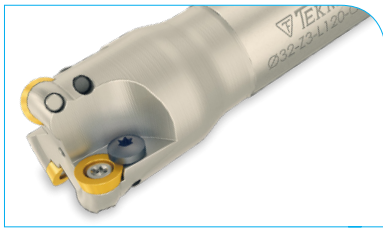

Order Code	Product Code	Dimensions (mm)						Insert	Price
		D	Z	L	d	L1			
R190	D20 d20 Z02 L120 RDMT 10	20	2	120	20	55	0,265		65 €
R192	D25 d25 Z02 L120 RDMT 10	25	2	120	25	50	0,435		65 €
R193	D30 d25 Z03 L120 RDMT 10	30	3	120	25	40	0,468		76 €
R194	D32 d25 Z03 L120 RDMT 10	32	3	120	25	40	0,484		76 €
R196	D35 d25 Z03 L120 RDMT 10	35	3	120	25	45	0,508	RDMT 1003	76 €
R198	D40 d25 Z04 L120 RDMT 10	40	4	120	25	45	0,558	ISO.	78 €
R200	D20 d20 Z02 L150 RDMT 10	20	2	150	20	60	0,336		75 €
R202	D25 d25 Z02 L150 RDMT 10	25	2	150	25	60	0,544		75 €
R203	D30 d25 Z03 L150 RDMT 10	30	3	150	25	40	0,586		79 €
R204	D32 d32 Z03 L150 RDMT 10	32	3	150	32	45	0,898		79 €
R206	D35 d32 Z03 L150 RDMT 10	35	3	150	32	45	0,923		79 €
R208	D40 d32 Z04 L150 RDMT 10	40	4	150	32	45	0,967		84 €
R210	D20 d20 Z02 L200 RDMT 10	20	2	200	20	80	0,477		83 €
R212	D25 d25 Z02 L200 RDMT 10	25	2	200	25	70	0,747		83 €
R213	D30 d25 Z03 L200 RDMT 10	30	3	200	25	40	0,789		88 €
R214	D32 d32 Z03 L200 RDMT 10	32	3	200	32	45	1,273		88 €
R216	D35 d32 Z03 L200 RDMT 10	35	3	200	32	45	1,227		88 €
R218	D40 d32 Z04 L200 RDMT 10	40	4	200	32	45	1,281		95 €

Code			
R190	TC071 M3,5x7	TC040 M3,5	
R192-R218	TC067 M3,5x8,5	TC040 M3,5	

**RDMT 12T3**

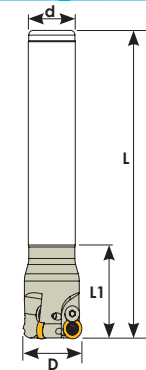
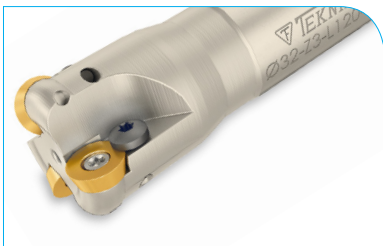

Order Code	Product Code	Dimensions (mm)						Insert	Price
		D	Z	L	d	L1			
R228	D25 d25 Z02 L120 RDMT 12	25	2	120	25	50	0,422		65 €
R229	D30 d25 Z02 L120 RDMT 12	30	2	120	25	40	0,456		65 €
R230	D32 d25 Z03 L120 RDMT 12	32	3	120	25	40	0,473		76 €
R232	D35 d25 Z03 L120 RDMT 12	35	3	120	25	40	0,485		76 €
R234	D40 d25 Z03 L120 RDMT 12	40	3	120	25	40	0,513	RDMT 12T3	76 €
R236	D25 d25 Z02 L150 RDMT 12	25	2	150	25	60	0,539	ISO.	75 €
R237	D30 d25 Z02 L150 RDMT 12	30	2	150	25	55	0,536		75 €
R238	D32 d32 Z03 L150 RDMT 12	32	3	150	32	45	0,876		79 €
R240	D35 d32 Z03 L150 RDMT 12	35	3	150	32	45	0,900		79 €
R242	D40 d32 Z03 L150 RDMT 12	40	3	150	32	45	0,956		79 €
R244	D25 d25 Z02 L200 RDMT 12	25	2	200	25	70	0,740		83 €
R245	D30 d25 Z02 L200 RDMT 12	30	2	200	25	55	0,784		83 €
R246	D32 d32 Z03 L200 RDMT 12	32	3	200	32	45	1,201		88 €
R248	D35 d32 Z03 L200 RDMT 12	35	3	200	32	45	1,226		88 €
R250	D40 d32 Z03 L200 RDMT 12	40	3	200	32	45	1,287		88 €
R255	D30 d25 Z02 L300 RDMT 12	30	2	300	25	55	1,168		109 €
R256	D32 d32 Z03 L300 RDMT 12	32	3	300	32	70	1,829		116 €
R258	D35 d32 Z03 L300 RDMT 12	35	3	300	32	45	1,855		116 €
R260	D40 d32 Z03 L300 RDMT 12	40	3	300	32	45	1,995		116 €

Code			
	TC067 M3,5x8,5	T15	TC040 M3,5

**TPKN 1103-1603-2204**

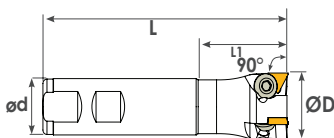
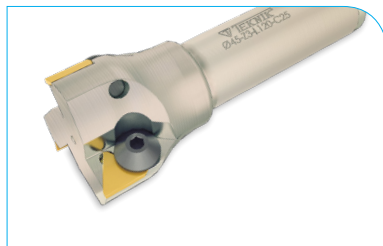

Order Code	Product Code	Dimensions (mm)						Insert	Price
		D	Z	L	d	L1			
S116	D22 d20 Z02 L120 TPKN 11	22	2	120	20	45	0,301		50 €
S118	D25 d25 Z02 L120 TPKN 11	25	2	120	25	45	0,438	TPKN 1103	50 €
S124	D32 d25 Z03 L120 TPKN 11	32	3	120	25	45	0,480	ISO	53 €
S128	D35 d25 Z02 L120 TPKN 16	35	2	120	25	45	0,507	TPKN 1603	55 €
S130	D40 d25 Z03 L120 TPKN 16	40	3	120	25	45	0,552	ISO	59 €
S132	D45 d25 Z03 L120 TPKN 16	45	3	120	25	45	0,606		64 €
S134	D50 d32 Z03 L120 TPKN 22	50	3	120	32	55	0,896	TPKN 2204 ISO	69 €

Code		
S116-S124	TC050 M6x14	3 Allen
S128-S132	TC052 M6x17	4 Allen
S134	TC054 M8x24	5 Allen

Kalite için **TEKNIK** çözüm  
Technical solution for quality



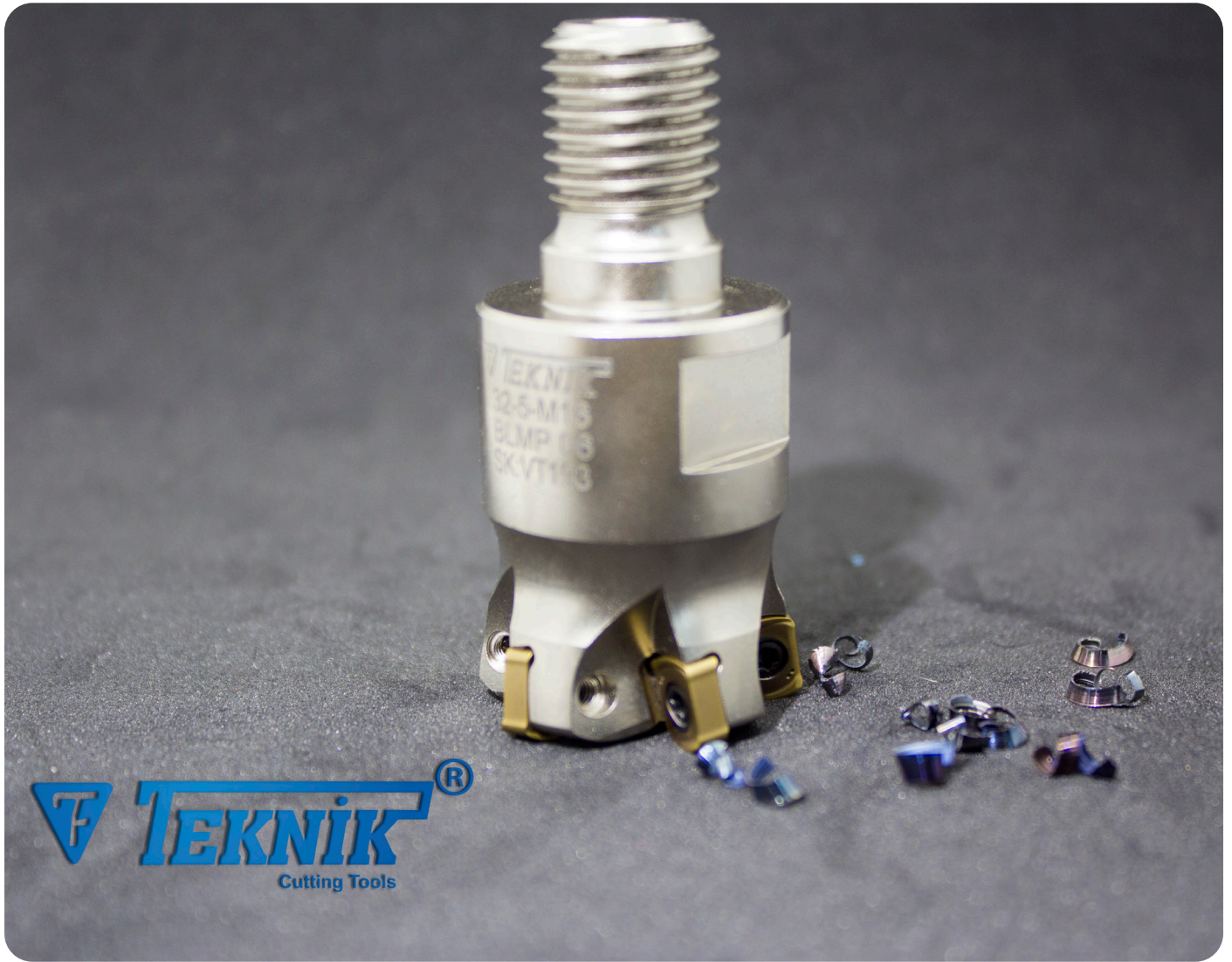

## Modular End Mill



[www.teknikcuttingtools.com](http://www.teknikcuttingtools.com)



Kalite için TEKNİK çözüm  
Technical solution for quality

58-61



### APXT 1003

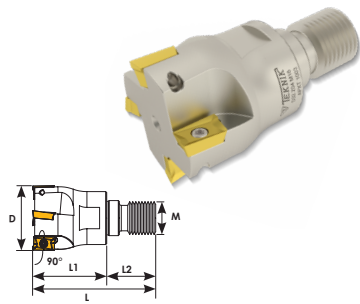

Order Code	Product Code	Dimensions (mm)							Insert	Price
		D	Z	M	L	L1	L2			
VT136	D16 Z02 M08 APXT 10	16	2	M08	41	25	16	0,050		68 €
VT138	D20 Z03 M10 APXT 10	20	3	M10	55	35	20	0,097	APXT 1003	73 €
VT140	D25 Z03 M12 APXT 10	25	3	M12	55	33	22	0,135	KRLY.	79 €
VT143	D32 Z04 M16 APXT 10	32	4	M16	60	36	24,5	0,195		79 €
VT146	D35 Z04 M16 APXT 10	35	4	M16	60	36	24,5	0,225		83 €
VT148	D40 Z05 M16 APXT 10	40	5	M16	60	36	24,5	0,266		83 €
VT150	D42 Z05 M16 APXT 10	42	5	M16	60	36	24,5	0,294		83 €



Compatible with KRLY insert. / Kompatibel für KRLY WP

### APKT 1604

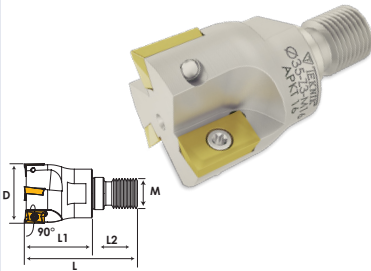

Order Code	Product Code	Dimensions (mm)							Insert	Price
		D	Z	M	L	L1	L2			
VT160	D25 Z02 M12 APKT 16	25	2	M12	55	33	22	0,107		68 €
VT163	D32 Z03 M16 APKT 16	32	3	M16	60	24	24,5	0,180	APKT 1604	73 €
VT166	D35 Z03 M16 APKT 16	35	3	M16	60	24	24,5	0,211	KRLY.	73 €
VT168	D40 Z04 M16 APKT 16	40	4	M16	60	24	24,5	0,238		79 €
VT170	D42 Z04 M16 APKT 16	42	4	M16	60	24	24,5	0,251		79 €



Compatible with KRLY insert. / Kompatibel für KRLY WP

### APMT 0602

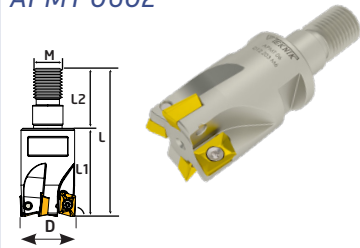

Order Code	Product Code	Dimensions (mm)							Insert	Price
		D	Z	M	L	L1	L2			
VT220	D10 Z02 M06 APMT 06	10	2	M06	41	25	16	0,011		68 €
VT221	D12 Z03 M06 APMT 06	12	3	M06	40	25	15	0,015	APMT 0603	73 €
VT222	D16 Z04 M08 APMT 06	16	4	M08	42	25	17	0,030	KRLY.	79 €
VT223	D20 Z05 M10 APMT 06	20	5	M10	51	31	20	0,064		83 €



Compatible with KRLY insert. / Kompatibel für KRLY WP

### APMT 0903

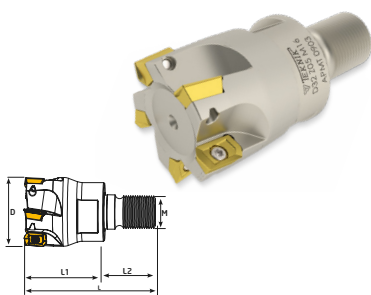

Order Code	Product Code	Dimensions (mm)							Insert	Price
		D	Z	M	L	L1	L2			
VT224	D16 Z02 M08 APMT 09	16	2	M08	41	25	16	0,040		68 €
VT225	D20 Z03 M10 APMT 09	20	3	M10	48	30	18	0,071	APMT 0903	73 €
VT226	D25 Z04 M12 APMT 09	25	4	M12	57	35	22	0,116	KRLY.	79 €
VT227	D32 Z05 M16 APMT 09	32	5	M16	65,3	40	25,3	0,229		83 €
VT228	D35 Z05 M16 APMT 09	35	5	M16	65,3	40	25,3	0,261		83 €
VT229	D40 Z06 M16 APMT 09	40	6	M16	65,3	40	25,3	0,299		83 €



Compatible with KRLY insert. / Kompatibel für KRLY WP



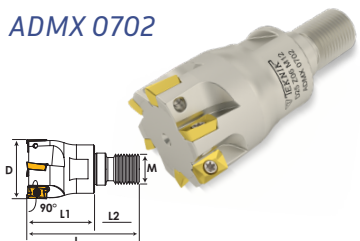

### ADMX 0702





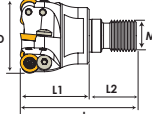



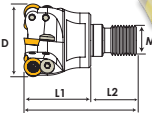

Order Code	Product Code	Dimensions (mm)							Insert	Price
		D	Z	M	L	L1	L2			
VT200	D16 Z04 M08 ADMX 07	16	4	M08	41	23	18	0,041	ADMX 0702	99 €
VT201	D20 Z05 M10 ADMX 07	20	5	M10	49	30	19	0,080	PRMT.	106 €
VT203	D32 Z08 M16 ADMX 07	32	8	M16	66	43	23	0,235		132 €





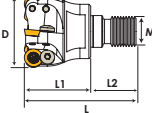

Compatible with PRMT insert. / Kompatibel für PRMT WP

RDMT 1003	Order Code	Product Code	Dimensions (mm)							Insert	Price
			D	Z	M	L	L1	L2			
	VT098	D20 Z02 M10 RDMT 10	20	2	M10	55	35	20	0,087		68 €
	VT100	D25 Z03 M12 RDMT 10	25	3	M12	55	33	22	0,114	RDMT 1003	73 €
	VT103	D32 Z03 M16 RDMT 10	32	3	M16	60	35,5	24,5	0,188	ISO.	73 €
	VT106	D35 Z04 M16 RDMT 10	35	4	M16	60	35,5	24,5	0,201		79 €
	VT107	D35 Z05 M16 RDMT 10	35	5	M16	60	35,5	24,5	0,211		83 €
	VT108	D40 Z05 M16 RDMT 10	40	5	M16	60	35,5	24,5	0,241		83 €
	VT110	D42 Z05 M16 RDMT 10	42	5	M16	60	35,5	24,5	0,265		83 €
<b>Code</b>											
VT098		TC071 M3,5x7	TC040 M3,5		T15						
VT100-VT110		TC067 M3,5x8,5									



RDMT 12T3	Order Code	Product Code	Dimensions (mm)							Insert	Price
			D	Z	M	L	L1	L2			
	VT120	D25 Z02 M12 RDMT 12	25	2	M12	55	33	22	0,106		68 €
	VT123	D32 Z03 M16 RDMT 12	32	3	M16	60	35,5	24,5	0,177	RDMT 12T3	73 €
	VT126	D35 Z03 M16 RDMT 12	35	3	M16	60	35,5	24,5	0,196	ISO.	73 €
	VT128	D40 Z04 M16 RDMT 12	40	4	M16	60	35,5	24,5	0,230		79 €
	VT130	D42 Z04 M16 RDMT 12	42	4	M16	60	35,5	24,5	0,237		79 €
				TC040 M3,5		T15					
		TC067 M3,5x8,5									

RPMT 10-12	Order Code	Product Code	Dimensions (mm)							Insert	Price
			D	Z	M	L	L1	L2			
	VT180	D25 Z03 M12 RPMT 10	25	3	M12	55	33	22	0,084	RPMT 10	73 €
	VT182	D32 Z03 M16 RPMT 10	32	3	M16	68	36	24,5	0,189	MTSBSH.	73 €
	VT174	D25 Z02 M12 RPMT 12	25	2	M12	55	33	22	0,109	RPMT 12	73 €
	VT176	D32 Z03 M16 RPMT 12	32	3	M16	60	34,7	25,3	0,164	MTSBSH.	73 €
<b>Code</b>				TC040 M3,5		T15					
VT180-VT182		TC067 M3,5x8,5	TC040 M3,5		T15						
VT174-VT176		TC067 M3,5x9									

Compatible with MTSBSH insert. / Kompatibel für MTSBSH WP

XNEX 0403	Order Code	Product Code	Dimensions (mm)							Insert	Price
			D	Z	M	L	L1	L2			
	VT245	D20 Z03 M10 XNEX 04	20	3	M10	46	28	18	0,073		73 €
	VT247	D25 Z04 M12 XNEX 04	25	4	M12	52	30	22	0,115	XNEX 0403	79 €
	VT249	D32 Z05 M16 XNEX 04	32	5	M16	65	40	25	0,253	SCO	83 €
			TC061 M2,5x7		T8						
		TC061 M2,5x7									

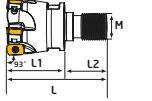
Compatible with SCO insert. / Kompatibel für SCO WP

EPMT 0603	Order Code	Product Code	Dimensions (mm)							Insert	Price
			D	Z	M	L	L1	L2			
	VT230	D16 Z02 M08 EPMT 06	16	2	M08	41	16	25	0,040		68 €
	VT231	D20 Z03 M10 EPMT 06	20	3	M10	48	18	30	0,070		73 €
	VT232	D25 Z04 M12 EPMT 06	25	4	M12	55	20	35	0,110	EPMT 0603	79 €
	VT233	D32 Z05 M16 EPMT 06	32	5	M16	60	25,3	34,7	0,197	HTCH.	83 €
	VT234	D35 Z05 M16 EPMT 06	35	5	M16	60	25,3	34,7	0,224		83 €
	VT235	D40 Z06 M16 EPMT 06	40	6	M16	60	25,3	34,7	0,256		87 €
	VT236	D42 Z06 M16 EPMT 06	42	6	M16	65,3	25,3	40	0,300		87 €
			TC060 M2,5x5,5		T7						
		TC060 M2,5x5,5									

Compatible with HTCH insert. / Kompatibel für HTCH WP

### LNMX 0603

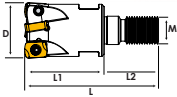

Order Code	Product Code	Dimensions (mm)							Insert	Price
		D	Z	M	L	L1	L2	kg		
VT152	D16 Z02 M08 LNMX 06	16	2	M08	42	25	17	0,031		68 €
VT153	D20 Z03 M10 LNMX 06	20	3	M10	51	30	21	0,060	LNMX 0603	73 €
VT154	D25 Z04 M12 LNMX 06	25	4	M12	59	35	24	0,120	KRLY	79 €
VT155	D32 Z05 M16 LNMX 06	32	5	M16	67	40	27	0,227		83 €

TC065-1M3x7      T8     

Compatible with KRLY insert. / Kompatibel für KRLY WP

### LNMU 0303

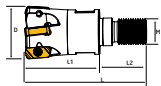

Order Code	Product Code	Dimensions (mm)							Insert	Price
		D	Z	M	L	L1	L2	kg		
VT300	D16 Z02 M08 LNMU 03	16	2	M08	42	25	17	0,029		68 €
VT302	D20 Z03 M10 LNMU 03	20	3	M10	49	30	19	0,061	LNMU 0303	73 €
VT304	D25 Z04 M12 LNMU 03	25	4	M12	57	35	22	0,108	TNGLY-OKE	79 €
VT305	D32 Z05 M16 LNMU 03	32	5	M16	63	40	23	0,227		83 €
VT307	D40 Z06 M16 LNMU 03	40	6	M16	63	40	23	0,272		89 €

TC065 M2,5x7      T8     

Compatible with TNGLY-OKE insert. / Kompatibel für TNGLY-OKE WP

### BLMP 0603

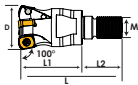

Order Code	Product Code	Dimensions (mm)							Insert	Price
		D	Z	M	L	L1	L2	kg		
VT190	D16 Z02 M08 BLMP 06	16	2	M08	41	25	16	0,044		68 €
VT191	D20 Z03 M10 BLMP 06	20	3	M10	48	30	18	0,081	BLMP 0603	73 €
VT192	D25 Z04 M12 BLMP 06	25	4	M12	57	35	22	0,119	TGTC.	79 €
VT193	D32 Z05 M16 BLMP 06	32	5	M16	65	40	25	0,233		83 €
VT194	D35 Z05 M16 BLMP 06	35	5	M16	65	40	25	0,240		83 €
VT195	D40 Z06 M16 BLMP 06	40	6	M16	68	43	25	0,291		89 €
VT196	D42 Z06 M16 BLMP 06	42	6	M16	68	43	25	0,313		89 €

TC064 M3x6,5      T8     

Compatible with TGTC insert. / Kompatibel für TGTC WP

### SDMT 09T3

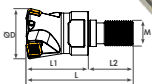









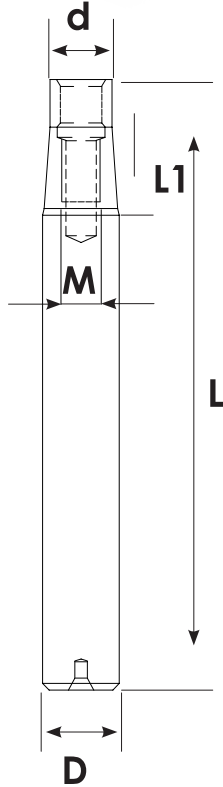





Order Code	Product Code	Dimensions (mm)							Insert	Price
		D	Z	M	L	L1	L2	kg		
VT240	D32 Z03 M16 SDMT 09	32	3	M16	69	40	29	0,211	SDMT 09T3	79 €
VT241	D35 Z03 M16 SDMT 09	35	3	M16	69	40	29	0,231	ZCC.	79 €
VT242	D40 Z04 M16 SDMT 09	40	3	M16	69	40	29	0,253		83 €

TC067 M3,5x8,5      T15     

Compatible with ZCC insert. / Kompatibel für ZCC WP

Modular End Mill Holder



Order Code	Product Code	Dimensions (mm)							Price
		D	d	L	L1	M			
VT500	D15 d12 L150 M8	15	12,7	150	30	M8	0,208	61€	
VT501	D15 d12 L150 M8-IC 	15	12,7	150	30	M8	0,202	64€	
VT502	D16 d14 L100 M8	16	14	100	30	M8	0,153	58€	
VT503	D16 d14 L100 M8-IC 	16	14	100	30	M8	0,150	61€	
VT504	D16 d14 L150 M8	16	14	150	30	M8	0,234	61€	
VT505	D16 d14 L150 M8-IC 	16	14	150	30	M8	0,230	64€	
VT506	D19 d17 L150 M10	19	17,7	150	30	M10	0,329	61€	
VT507	D19 d17 L150 M10-IC 	19	17,7	150	30	M10	0,324	64€	
VT508	D20 d17 L100 M10	20	17,7	100	30	M10	0,238	58€	
VT509	D20 d17 L100 M10-IC 	20	17,7	100	30	M10	0,235	61€	
VT510	D20 d17 L150 M10	20	17,7	150	40	M10	0,357	61€	
VT511	D20 d17 L150 M10-IC 	20	17,7	150	40	M10	0,354	64€	
VT512	D24 d20 L150 M12	24	20,7	150	40	M12	0,508	64€	
VT513	D24 d20 L150 M12-IC 	24	20,7	150	40	M12	0,502	67€	
VT514	D25 d20 L150 M12	25	20,7	150	40	M12	0,546	64€	
VT515	D25 d20 L150 M12-IC 	25	20,7	150	40	M12	0,542	67€	
VT516	D25 d20 L200 M12	25	20,7	200	40	M12	0,680	66€	
VT517	D25 d20 L200 M12-IC 	25	20,7	200	40	M12	0,675	69€	
VT518	D25 d20 L250 M12	25	20,7	250	40	M12	0,700	69€	
VT519	D25 d20 L250 M12-IC 	25	20,7	250	40	M12	0,695	73€	
VT520	D32 d28 L170 M16	32	28,7	170	40	M16	0,790	66€	
VT521	D32 d28 L170 M16-IC 	32	28,7	170	40	M16	0,784	69€	
VT522	D32 d28 L220 M16	32	28,7	220	40	M16	0,860	72€	
VT523	D32 d28 L220 M16-IC 	32	28,7	220	40	M16	0,854	73€	
VT524	D32 d28 L300 M16	32	28,7	300	40	M16	1,380	77€	
VT525	D32 d28 L300 M16 -IC 	32	28,7	300	40	M16	1,375	83€	

IK Codes are coolant.

**Kalite için TEKNİK çözüm**  
Technical solution for quality



## Threading Holders



[www.teknikcuttingtools.com](http://www.teknikcuttingtools.com)



Kalite için TEKNİK çözüm  
Technical solution for quality

64-68



External Threading Holder/R

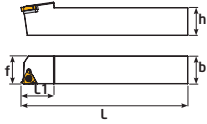
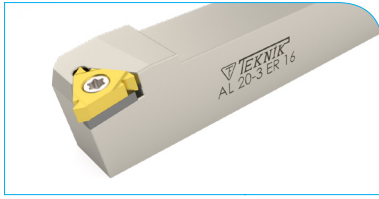

Order Code	Product Code	Dimensions (mm)						Insert	Price
		L	L1	h	f	b			
D261	AL 1212 J16- ER16	12	12	16	110	20	0,140		33 €
D259	AL 1616 H16- ER16	16	16	16	100	22	0,250	16 ER	33 €
D258	AL 2020 K16- ER16	20	20	20	125	25	0,410		36 €
D260	AL 2525 M16- ER16	25	25	25	150	30	0,750		39 €
D262	AL 3232 P16- ER16	32	32	32	170	30	1,430		46 €
D265	AL 2020 M22- ER22	150	30	20	20	20	0,458	22 ER	36 €
D266	AL 2525 M22- ER22	25	25	25	150	30	0,740		39 €

Code					
D261-D262	TC068 M3,5x11	TA040	TC048 M5	T15	
D265-D266	TC078 M4x11	--	--		

External Threading Holder/L

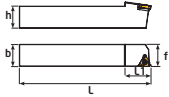
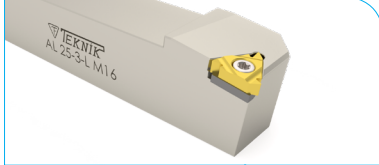

Order Code	Product Code	Dimensions (mm)						Insert	Price
		L	L1	h	f	b			
D268	AL 2020 K16 - L IR16	20	20	20	125	25	0,410		36 €
D269	AL 2525 M16 - L IR16	25	25	25	150	30	0,754	16 IR	39 €
D266-1	AL 2525 M22 - L IR22	25	25	25	150	30	0,748	22 IR	39 €

Code					
D268-D269	TC068 M3,5x11	TA040	TC048 M5	T15	
D266-1	TC078 M4x11	--	--		

Internal Threading Holder/R

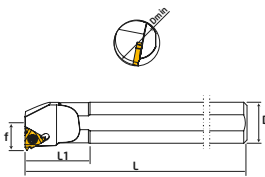
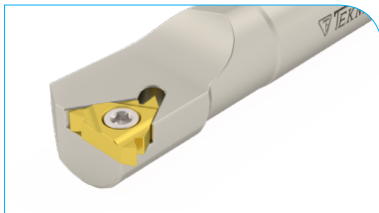

Order Code	Product Code	Dimensions (mm)					Hole Diameter		Insert	Price
		D	L	L1	f	Dmin				
K348	S10J STIR- IR11	10	110	20	6	12	0,079		23 €	
K350	S12K STIR- IR11	12	125	25	7,2	14	0,117	11 IR	24 €	
K352	S16Q STIR- IR16	16	180	40	11	20	0,286		29 €	
K354	S20Q STIR- IR16	20	180	40	13	25	0,436	16 IR	31 €	
K356	S25R STIR- IR16	25	200	40	16	29	0,762		33 €	
K358	S32T STIR- IR16	32	300	60	19,5	36	1,829		51 €	
K358-1	S20Q STIR- IR22	20	180	40	14	24	0,431		31 €	
K359	S25R STIR- IR22	25	200	40	17	32	0,757	22 IR	33 €	
K360	S32T STIR- IR22	32	300	60	19,5	36	1,818		51 €	
K360-1	S40T STIR- IR22	40	300	60	24,5	45	2,831		64 €	

Code							
K348-K350	TC060 M2,5x5,5			T8			
K352-K358	TC067 M3,5x8,5			T10			
K358-1-K360-1	TC078 M4x11			T15			

Internal Threading Holder/L

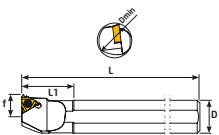
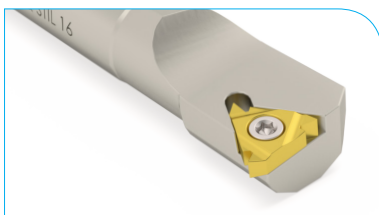

Order Code	Product Code	Dimensions (mm)					Hole Diameter		Insert	Price
		D	L	L1	f	Dmin				
K360-2	S10J STIL-ER11	10	110	20	6	12	0,079	11 ER	23 €	
K361	S16Q STIL-ER16	16	180	40	11	20	0,286		29 €	
K362	S20Q STIL-ER16	20	180	40	13	25	0,436	16 ER	31 €	
K363	S25R STIL-ER16	25	200	40	16	29	0,762		33 €	

Code					
K360-2	TC060 M2,5x5,5		T8		
K361-K363	TC067 M3,5x8,5		T10		



External Threading Holder/R

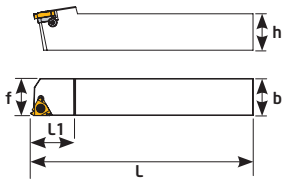

Order Code	Product Code	Dimensions (mm)						Insert	Price
		h	b	f	L	L1			
D494	SER 0808 H11 - ER11	8	8	11	100	20	0,061		33 €
D495	SER 1010 H11 - ER11	10	10	11	100	20	0,091	11 ER	33 €
D496	SER 1010 M11 - ER11	10	10	11	150	20	0,136		41 €
D497	SER 1212 K11 - ER11	12	12	12	125	20	0,160		33 €
D498	SER 1212 M11 - ER11	12	12	12	150	20	0,193		41 €
D500	SER 1212 J16 - ER16	12	12	16	110	22	0,110		37 €
D501	SER 1616 H16 - ER16	16	16	16	100	25	0,220		37 €
D502	SER 2020 K16 - ER16	20	20	20	125	30	0,410	16 ER	41 €
D503	SER 2525 M16 - ER16	25	25	25	150	30	0,750		44 €
D504	SER 3232 P16 - ER16	32	32	32	170	30	1,410		52 €
D505	SER 2525 M22 - ER22	25	25	25	150	30	0,740		45 €
D506	SER 3232 P22 - ER22	32	32	32	170	30	1,430	22 ER	54 €
D507	SER 4040 R22 - ER22	40	40	40	200	36	1,396		84 €
D491	SER 2525 M27 - ER27	25	25	32	150	36	2,585		87 €
D492	SER 3232 P27 - ER27	32	32	32	170	40	0,791	27 ER	94 €
D493	SER 4040 R27 - ER27	40	40	40	200	40	1,405		107 €

Code					
D494-D498	TC060 M2,5x5,5	--	--		T8
D500-D504	TC068 M3,5x11	TA061	TA060	TC062 M3	T15
D505-D507	TC077 M4x15	TA062			
D491-D493	TC086 M5x18	TA064	--	TC053 M4	T20

External Threading Holder/L

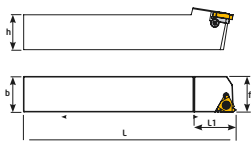
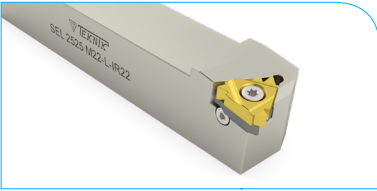

Order Code	Product Code	Dimensions (mm)						Insert	Price
		h	b	f	L	L1			
D508	SEL 1212 J16 -L- IR16	12	12	16	110	22	0,119		37 €
D509	SEL 1616H16 -L- IR16	16	16	16	100	25	0,223		37 €
D510	SEL 2020 K16 -L- IR16	20	20	20	125	30	0,414	16 IR	41 €
D511	SEL 2525 M16 -L- IR16	25	25	25	150	30	0,753		44 €
D512	SEL 3232 P16 -L- IR16	32	32	32	170	30	1,417		52 €
D513	SEL 2525 M22 -L- IR22	25	25	25	150	30	0,749	22 IR	45 €
D515	SEL 3232 P22 -L- IR22	32	32	32	170	36	1,434		54 €

Code					
D508-D512	TC068 M3,5x11	TA060	BSP010	TC062 M3	T15
D513-D515	TC077 M4x15	TA063			

Internal Threading Holder/R

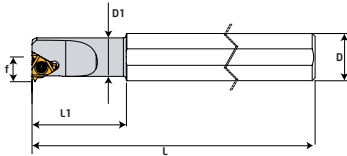
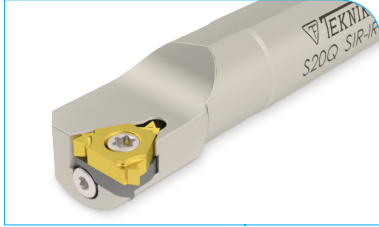

Order Code	Product Code	Dimensions (mm)						Hole Diameter	kg	Insert	Price
		D	D1	L	L1	f	Dmin				
K337-1	SIR S12H - IR06	12	5,1	100	12	4,3	6	0,089	6 IR	34 €	
K337-2	SIR S16K - IR08	16	6,6	125	18	5,3	7,8	0,195	8 IR	34 €	
K337-3	SIR S10H - IR11	10	-	100	20	7,4	12	0,063		25 €	
K337-4	SIR S16K - IR11	16	10	125	25	7,4	12	0,167	11 IR	29 €	
K337-5	SIR S16L - IR11	16	13	140	32	8,9	15	0,207		31 €	
K337-6	SIR S16M - IR16	16	13	150	32	10,2	16	0,221		31 €	
K337-7	SIR S20P - IR16	20	16	170	40	11,7	19	0,381		36 €	
K338	SIR S20Q - IR16	20	-	180	40	13,4	24	0,440	16 IR	36 €	
K339	SIR S25R - IR16	25	-	200	45	16,1	29	0,760		39 €	
K340	SIR S32T - IR16	32	-	300	60	21,5	39	1,830		56 €	
K341	SIR S40T - IR16	40	-	300	60	24,5	45	2,830		68 €	
K342	SIR S50U - IR16	50	-	350	75	28,7	54	5,337		94 €	
K342-1	SIR S20P - IR22	20	-	170	40	15,6	24	0,433		34 €	
K343	SIR S25R - IR22	25	-	200	45	16,1	30	0,760		42 €	
K344	SIR S32T - IR22	32	-	300	40	22	39	1,820	22 IR	59 €	
K345	SIR S40T - IR22	40	-	300	60	25,6	46	2,840		69 €	
K346	SIR S50U - IR22	50	-	350	75	30,6	56	5,335		98 €	
K347	SIR S32S - IR27	32	-	250	60	22,6	40	1,523		96 €	
K347-1	SIR S40T - IR27	40	-	300	60	26,6	48	2,890	27 IR	106 €	
K347-2	SIR S50U - IR27	50	-	350	75	31,6	58	5,177		124 €	
K347-4	SIR S60V - IR27	60	-	400	75	36,6	68	8,700		141 €	

Code					
K337-1	TC058 M2x4,2	--	--	--	T6
K337-2	TC058-1 M2x4,6	--	--	--	T6
K337-3-K337-5	TC060 M2,5x5,5	--	--	--	T8
K337-6-K337-7	TC067 M3,5x8,5	--	--	--	T8
K338-K342	TC068 M3,5x11	TA060	BSP010	TC062 M3	T15
K342-1	TC078 M4x11	--	--	--	T15
K343-K346	TC077 M4x15	TA063	BSP010	TC062 M3	T15
K347 - K347-4	TC086 M5x18	TA065	--	TC053M4	T20

Internal Threading Holder/R  
With Coolant

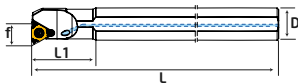
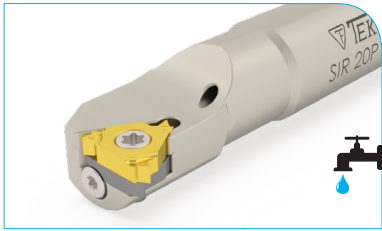

Order Code	Product Code	Dimensions (mm)					Hole Diameter	K9	Insert	Price
		D	L	L1	f	Dmin				
K327-1	SIR A16K - IR11	16	125	25	7,4	12	0,165	11 IR	36 €	
K327-2	SIR A16M - IR16	16	150	32	10,2	16	0,220		36 €	
K327-3	SIR A20P - IR16	20	170	40	11,7	19	0,380		42 €	
K327-4	SIR A20P - IR16	20	170	40	13,7	24	0,412	16 IR	42 €	
K327-5	SIR A25R - IR16	25	200	45	16,2	29	0,710		45 €	
K327-6	SIR A25R - IR22	25	200	45	18,1	29	0,730	22 IR	48 €	

Code						
K327-1	TC060 M2,5x5,5	--	--	--	T8	
K327-2-K327-3	TC067 M3,5x8,5	--	--	--	T8	
K327-4-K327-5	TC068 M3,5x11	TA060		BSP10	TC062 M3	T15
K327-6	TC077 M4x15	TA063				

Internal Threading Holder/L

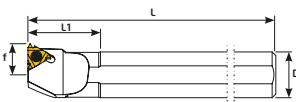
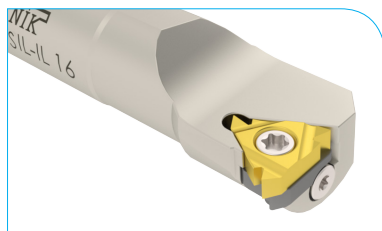

Order Code	Product Code	Dimensions (mm)					Hole Diameter	K9	Insert	Price
		D	L	L1	f	Dmin				
K330	SIL S20Q - ER16	20	180	40	13,4	24	0,440		36 €	
K331	SIL S25R - ER16	25	200	45	16,1	29	0,760		39 €	
K332	SIL S32T - ER16	32	300	60	21,5	39	1,830	16ER	56 €	
K333	SIL S40T - ER16	40	300	60	24,5	45	2,830		68 €	
K334	SIL S25R - ER22	25	200	45	16,1	30	0,760		42 €	
K335	SIL S32T - ER22	32	300	40	22	39	1,820	22ER	59 €	
K336	SIL S40T - ER22	40	300	60	24,5	50	2,840		69 €	

Code						
K330-K333	TC068 M3,5x11	TA061		BSP010	TC062 M3	T15
K334-K336	TC077 M4x15	TA062				

Thread Cutting Tool  
With Coolant

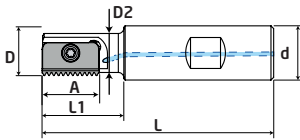

Order Code	Product Code	Dimensions (mm)								Insert	Price
		A	D	d	D2	L	L1				
DC201	D9,5 d20 L085 A12 S12	12	9,5	20	7,5	85	14	0,195	S12	83 €	
DC202	D9,9 d20 L085 A12 S12	12	9,9	20	7,6	85	16	0,191	S12	83 €	
DC203	D12 d20 L075 A14 S14	14	12	20	8,9	75	20	0,156	S14	83 €	
DC204	D14,5 d20 L085 A14 S14	14	14,5	20	11,2	85	25	0,179	S14	83 €	
DC205	D17 d20 L085 A14 S14	14	17	20	13,4	85	30	0,180	S14	83 €	
DC206	D18 d20 L085 A21 S21	21	18	20	14,4	85	30	0,176	S21	86 €	
DC207	D21 d20 L094 A21 S21	21	21	20	16,5	94	40	0,204	S21	86 €	
DC208	D29 d25 L110 A30 S30	30	29	25	22,4	110	50	0,390	S30	88 €	
DC209	D48 d40 L153 A40 S40	40	48	40	35	153	78	1,325	S40	94 €	

Code			
DC200-DC202	TC092 M2,5x5,5		
DC203-DC205	TC096 M2,5x7	T8	
DC206-DC207	TC074 M4x10	T15	
DC208	TC256 M5x12		
DC209	TC086 M5x18	T20	

Thread Cutting Tool  
With Coolant

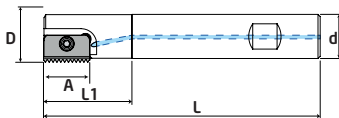

Order Code	Product Code	Dimensions (mm)						Insert	Price
		A	D	d	L	L1			
DC210	D25 d20 L125 A21 S21	21	25	20	125	40	0,320	S21	88 €
DC211	D31 d25 L150 A30 S30	30	31	25	150	60	0,597	S30	91 €
DC212	D38 d32 L150 A30 S30	30	38	32	150	60	1,005	S30	91 €
DC213	D48 d40 L210 A40 S40	40	48	40	210	78	2,068	S40	97 €

Code			
DC210	TC074 M4x10	T15	
DC211-DC212	TC256 M5x12		
DC213	TC086 M5x18	T20	

Thread Cutting Tool  
With Coolant

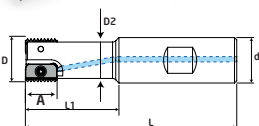

Order Code	Product Code	Dimensions (mm)								Insert	Price
		A	D	d	D2	L	L1				
DC214	D20 d20 L093 A14 S14	14	20	20	16	93	41	0,202	S14	106 €	
DC215	D30 d25 L108 A21 S21	21	30	25	24	108	52	0,401	S21	108 €	
DC216	D40 d32 L130 A30 S30	30	40	32	30	130	70	0,781	S30	108 €	
DC217	D50 d40 L153 A40 S40	40	50	40	38	153	78	1,455	S40	116 €	

Code			
DC214	TC093 M2,5x7	T8	
DC215	TC074 M4x10	T15	
DC216	TC256 M5x12		
DC217	TC086 M5x18	T20	

# Turning Holder With Coolant

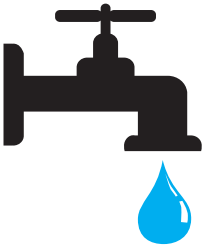
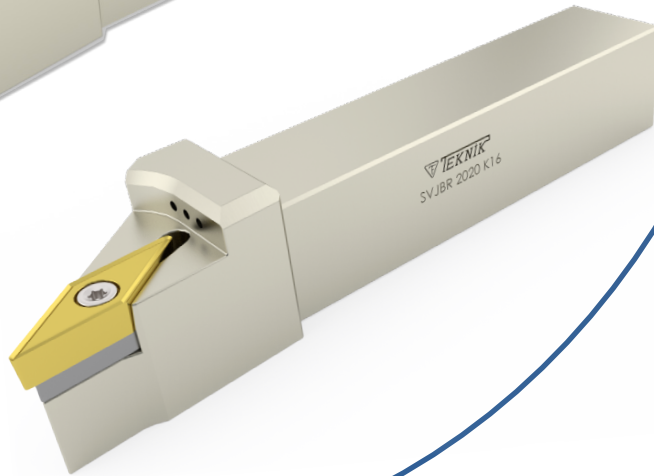
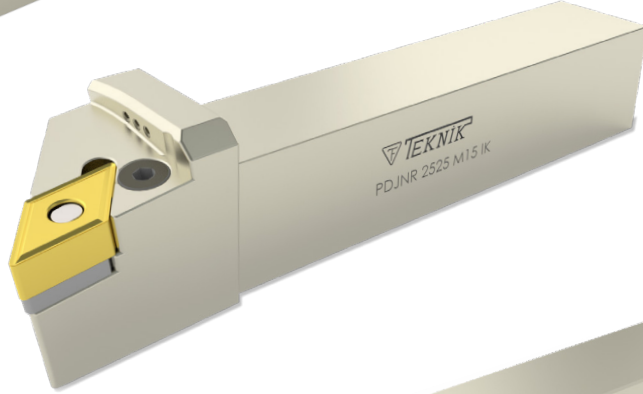
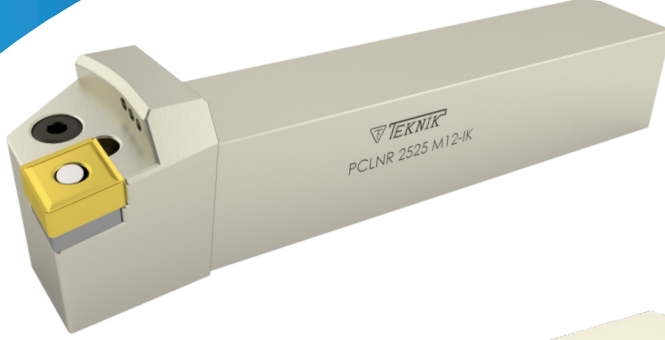

[www.teknikcuttingtools.com](http://www.teknikcuttingtools.com)



Kalite için TEKNİK çözüm

Technical solution for quality

70-75



93° PDJNR IC

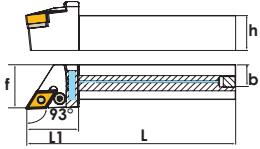
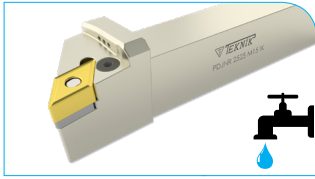

Order Code	Product Code	Dimensions (mm)						Insert	Price
		L	L1	h	f	b			
AP110	PDJNR 2020 K15-IKG1/8	125	30	20	25	20	0,409	DNMG 1506	77 €
AP112	PDJNR 2525 M15-IKG1/8	150	38	25	32	25	0,759	ISO.	81 €
<b>Code</b>									
AP110	TH822	TA014-1	TS-4	TL4B	3 Allen				
AP112	TH825								

93° PDJNL IC

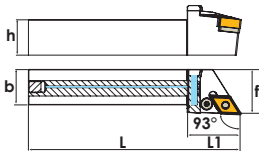
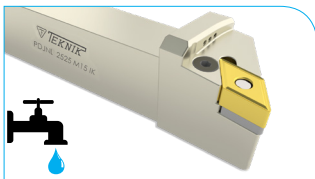

Order Code	Product Code	Dimensions (mm)						Insert	Price
		L	L1	h	f	b			
AP122	PDJNL 2020 K15-IKG1/8	125	40	20	25	20	0,409	DNMG 1506	77 €
AP124	PDJNL 2525 M15-IKG1/8	150	40	25	32	25	0,759	ISO.	81 €
<b>Code</b>									
AP122	TH822	TA014-1	TS-4	TL4B	3 Allen				
AP124	TH825								

95° PCLNR IC

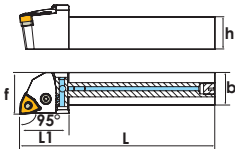

Order Code	Product Code	Dimensions (mm)						Insert	Price
		L	L1	h	f	b			
AP129	PCLNR 1616 H12-IKG1/8	100	28	16	20	16	0,236	CNMG 1204	77 €
AP130	PCLNR 2020 K12-IKG1/8	125	28	20	25	20	0,428	ISO.	77 €
AP132	PCLNR 2525 M12-IKG1/8	150	30	25	32	25	0,781		81 €
<b>Code</b>									
AP129	TH818	TA016-1	TS4	TL4	3 Allen				
AP130-AP132	TH821								

95° PCLNL IC

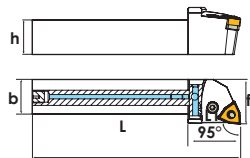

Order Code	Product Code	Dimensions (mm)						Insert	Price
		L	L1	h	f	b			
AP139	PCLNL 1616 H12-IKG1/8	100	28	16	20	16	0,236		77 €
AP140	PCLNL 2020 K12-IKG1/8	125	28	20	25	20	0,428	CNMG 1204	77 €
AP142	PCLNL 2525 M12-IKG1/8	150	30	25	32	25	0,781	ISO.	81 €
<b>Code</b>									
AP139	TH818	TA016-1	TS4	TL4	3 Allen				
AP140-AP142	TH821								

95° PWLNR 08 IC

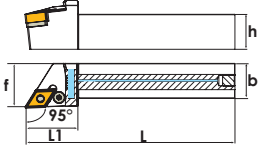
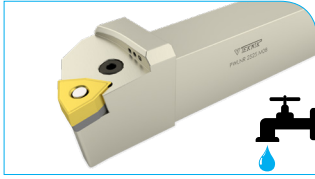

Order Code	Product Code	Dimensions (mm)						Insert	Price
		L	L1	h	f	b			
AP150	PWLNR 2020 K08-IKG1/8	125	30	20	25	20	0,425	WNMG 0804	77 €
AP151	PWLNR 2525 M08-IKG1/8	150	38	25	32	25	0,782	ISO.	81 €
						3 Allen			
		TH821	TA020-1	TS4	TL4	3 Allen			

95° PWLNL 08 IC

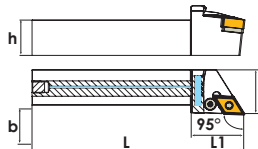

Order Code	Product Code	Dimensions (mm)						Insert	Price
		L	L1	h	f	b			
AP155	PWLNL 2020 K08-IKG1/8	125	30	20	25	20	0,425	WNMG 0804	77 €
AP156	PWLNL 2525 M08-IKG1/8	150	38	25	32	25	0,782	ISO.	81 €
						3 Allen			
		TH821	TA020-1	TS4	TL4	3 Allen			

95° PWLNR 06 IC

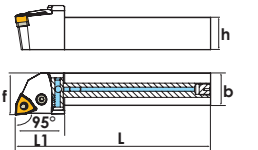
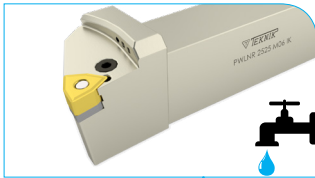

Order Code	Product Code	Dimensions (mm)						Insert	Price
		L	L1	h	f	b			
AP158	PWLNR 1616 H06-IKG1/8	100	30	16	20	16	0,218		77 €
AP160	PWLNR 2020 K06-IKG1/8	125	30	20	25	20	0,415	WNMG 0604	77 €
AP161	PWLNR 2525 M06-IKG1/8	150	30	25	32	25	0,756	ISO.	81 €
						2,5 Allen			
		TH617	TA021	TS3	TL3	2,5 Allen			

95° PWLNL 06 IC

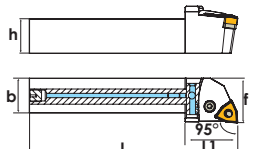
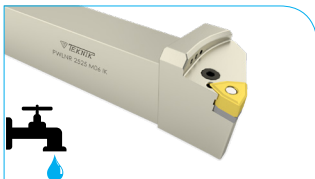

Order Code	Product Code	Dimensions (mm)						Insert	Price
		L	L1	h	f	b			
AP164	PWLNL 1616 H06-IKG1/8	100	30	16	20	16	0,218		77 €
AP165	PWLNL 2020 K06-IKG1/8	125	30	20	25	20	0,415	WNMG 0604	77 €
AP166	PWLNL 2525 M06-IKG1/8	150	30	25	32	25	0,756	ISO.	81 €
						2,5 Allen			
		TH617	TA021	TS3	TL3	2,5 Allen			

95° SCLCR IC

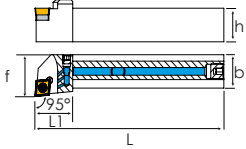
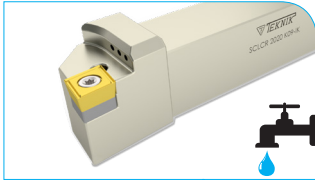

Order Code	Product Code	Dimensions (mm)						Insert	Price
		L	L1	h	f	b			
AP500	SCLCR 1616 H09-İK	100	25	16	20	16	0,205	CCMT 09T3	66 €
AP501	SCLCR 2020 K09-İK	125	25	20	25	20	0,418	ISO.	68 €
AP502	SCLCR 2020 K12-İK	125	30	20	25	20	0,370	CCMT 1204	68 €
AP503	SCLCR 2525 M12-İK	150	30	25	32	25	0,771		72 €

Code					
AP500-AP501	TC068 M3,5x11	TA015	TC048 M5	T15	
AP502-AP503	TC075 M4x11	TA15-1	TC049-1M6		

95° SCLCL IC

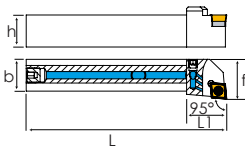
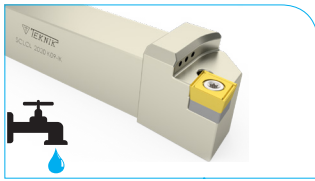

Order Code	Product Code	Dimensions (mm)						Insert	Price
		L	L1	h	f	b			
AP505	SCLCL 1616 H09-İK	100	25	16	20	16	0,205	CCMT 09T3	66 €
AP506	SCLCL 2020 K09-İK	125	25	20	25	20	0,418	ISO.	68 €
AP507	SCLCL 2020 K12-İK	125	30	20	25	20	0,375	CCMT 1204	68 €
AP508	SCLCL 2525 M12-İK	150	30	25	32	25	0,771		72 €

Code					
AP505-AP506	TC068 M3,5x11	TA015	TC048 M5	T15	
AP507-AP508	TC075 M4x11	TA15-1	TC049-1M6		

93° SDJCR IC

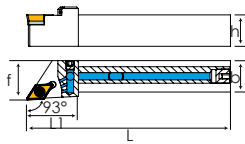
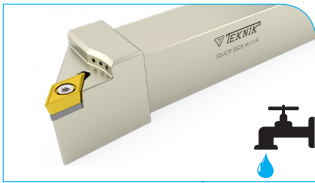

Order Code	Product Code	Dimensions (mm)						Insert	Price
		L	L1	h	f	b			
AP509	SDJCR 1212 J11-İK	110	32	12	16	12	0,107	DCMT 11T3	66 €
AP510	SDJCR 1616 H11-İK	100	32	16	20	16	0,204	ISO.	66 €
AP511	SDJCR 2020 K11-İK	125	32	20	25	20	0,404		68 €
AP512	SDJCR 2525 M11-İK	150	35	25	32	25	0,735		72 €

TC068 M3,5x11	TA030	TC048 M5	T8	

93° SDJCL IC

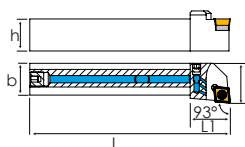
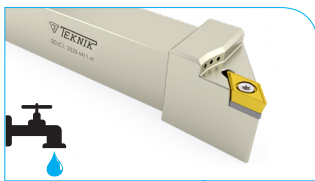

Order Code	Product Code	Dimensions (mm)						Insert	Price
		L	L1	h	f	b			
AP514	SDJCL 1212 J11-İK	110	32	12	16	12	0,107	DCMT 11T3	66 €
AP515	SDJCL 1616 H11-İK	100	32	16	16	16	0,204	ISO.	66 €
AP516	SDJCL 2020 K11-İK	125	32	20	25	20	0,404		68 €
AP517	SDJCL 2525 M11-İK	150	35	25	32	25	0,735		72 €



TC068 M3,5x11	TA030	TC048 M5	T8	

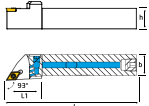
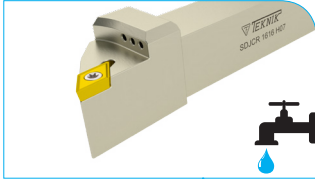

**NEW  
PRODUCT**

93° SDJCR IC





Order Code	Product Code	Dimensions (mm)						Insert	Price
		L	L1	h	f	b	kg		
AP560	SDJCR 1212 K07-IC	125	27	12	16	12	0,175		64 €
AP561	SDJCR 1616 H07-IC	100	27	16	20	16	0,210	DCMT 0702	66 €
AP562	SDJCR 2020 K07-IC	125	27	20	25	20	0,400	ISO.	68 €
<b>Code</b>									
AP560-AP562		TC060 M2,5x5,5		T8					

**NEW  
PRODUCT**

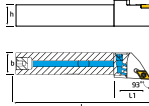
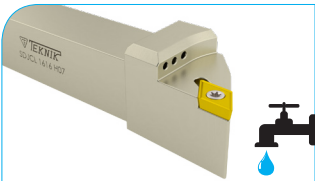
93° SDJCL IC





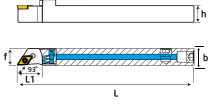
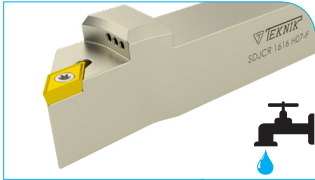

Order Code	Product Code	Dimensions (mm)						Insert	Price
		L	L1	h	f	b	kg		
AP565	SDJCL 1212 K07-IC	125	16	16	12	16	0,175		64 €
AP566	SDJCL 1616 H07-IC	100	27	16	20	16	0,210	DCMT 0702	66 €
AP567	SDJCL 2020 K07-IC	125	27	20	25	20	0,400	ISO.	68 €
<b>Code</b>									
AP565-AP567		TC060 M2,5x5,5		T8					

**NEW  
PRODUCT**

93° SDJCR -F IC





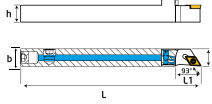
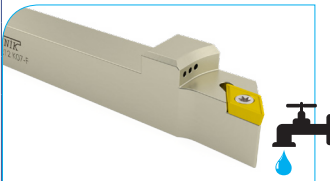

Order Code	Product Code	Dimensions (mm)						Insert	Price
		L	L1	h	f	b	kg		
AP569	SDJCR 1212 K07-F-IC	125	27	12	16	12	0,175	ISO.	64 €
AP570	SDJCR 1616 H07-F-IC	100	27	16	16	16	0,210	DCMT 0702	66 €
AP571	SDJCR 1212 J11-F-IC	110	32	12	12	12	0,106	DCMT 11T3	64 €
AP572	SDJCR 1616 H11-F-IC	100	32	16	16	16	0,167		66 €
<b>Code</b>									
AP569-AP570		TC060 M2,5x5,5	---	---	T8				
AP571-AP572		TC067 M3,5x8,5	TA030	TC048 M5	T15				

**NEW  
PRODUCT**

93° SDJCL-F IC



Order Code	Product Code	Dimensions (mm)						Insert	Price
		L	L1	h	f	b	kg		
AP573	SDJCL 1212 K07 F-IC	125	27	12	12	12	0,175	ISO.	64 €
AP574	SDJCL 1616 H07-F-IC	100	27	16	16	16	0,210	DCMT 0702	66 €
AP575	SDJCL 1212 J11-F-IC	110	32	12	12	12	0,106	DCMT 11T3	64 €
<b>Code</b>									
AP573-AP574		TC060 M2,5x5,5	---	---	T8				
AP575		TC067 M3,5x8,5	TA030	TC048 M5	T15				

93° SVJBR IC

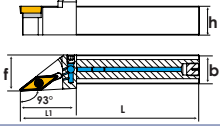
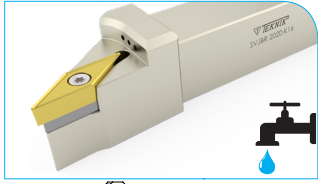

Order Code	Product Code	Dimensions (mm)						Insert	Price
		L	L1	h	f	b	kg		
AP540	SVJBR 1010 J11-1K	110	30	10	12	10	0,097	VBMT 1103	64 €
AP541	SVJBR 1212 J11-1K	110	32	12	16	12	0,141	ISO.	64 €
AP545	SVJBR 2020 K16-1K	125	40	20	25	20	0,192	VBMT 1604	68 €
AP546	SVJBR 2525 M16-1K	150	40	25	32	25	0,192	ISO.	72 €

Code	TC061 M2,5x6,5	TA034	TC048	T8	T15
AP540-AP541	TC061 M2,5x6,5	---	---	T8	T15
AP545-AP546	TC068 M3,5x11	---	---	T8	T15

93° SVJBL IC

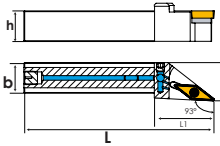
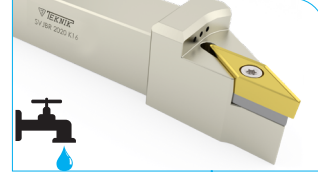

Order Code	Product Code	Dimensions (mm)						Insert	Price
		L	L1	h	f	b	kg		
AP550	SVJBL 1010 J11-1K	110	30	10	12	10	0,097	VBMT 1103	64 €
AP551	SVJBL 1212 J11-1K	110	32	12	16	12	0,141	ISO.	64 €
AP552	SVJBL 1616 H11-1K	100	35	16	20	16	0,167		66 €
AP555	SVJBL 2020 K16-1K	125	40	20	25	20	0,192	VBMT 1604	68 €
AP556	SVJBL 2525 M16-1K	150	40	25	32	25	0,192	ISO.	72 €

Code	TC061 M2,5x6,5	TA034	TC048	T8	T15
AP550-AP552	TC061 M2,5x6,5	---	---	T8	T15
AP555-AP556	TC068 M3,5x11	---	---	T8	T15

93° SVJCR IC

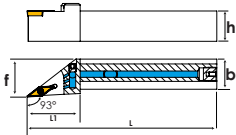
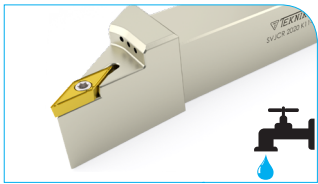

Order Code	Product Code	Dimensions (mm)						Insert	Price
		L	L1	h	f	b	kg		
AP519	SVJCR 1212 J11-1K	110	32	12	16	12	0,109	VCMT 1103	64 €
AP520	SVJCR 1616 H11-1K	100	25	16	20	16	0,204	ISO.	66 €
AP521	SVJCR 2020 K11-1K	125	33	20	25	20	0,378		68 €
AP522	SVJCR 2525 M11-1K	150	40	25	32	25	0,690		72 €
AP525	SVJCR 2020 K16-1K	125	33	20	25	20	0,385	VCMT 1604	68 €
AP526	SVJCR 2525 M16-1K	150	40	25	32	25	0,683	ISO.	72 €

Code	TC061 M2,5x6,5	TA034	TC048	T8	T15
AP519-AP522	TC061 M2,5x6,5	---	---	T8	T15
AP525-AP526	TC068 M3,5x11	---	---	T8	T15

93° SVJCL IC

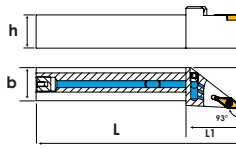

Order Code	Product Code	Dimensions (mm)						Insert	Price
		L	L1	h	f	b	kg		
AP529	SVJCL 1212 J11-1K	110	32	12	16	12	0,109	VCMT 1103	64 €
AP530	SVJCL 1616 H11-1K	100	25	16	20	16	0,204	ISO.	66 €
AP531	SVJCL 2020 K11-1K	125	33	20	25	20	0,378		68 €
AP532	SVJCL 2525 M11-1K	150	40	25	32	25	0,627		72 €
AP535	SVJCL 2020 K16-1K	125	33	20	25	20	0,385	VCMT 1604	68 €
AP536	SVJCL 2525 M16-1K	150	40	25	32	25	0,683	ISO.	72 €

Code	TC061 M2,5x6,5	TA034	TC048	T8	T15
AP529-AP532	TC061 M2,5x6,5	---	---	T8	T15
AP535-AP536	TC068 M3,5x11	---	---	T8	T15

93° SVJBR-F IC

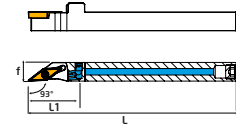
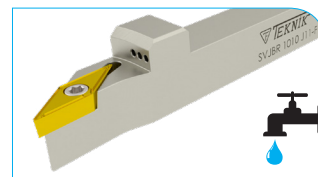

Order Code	Product Code	Dimensions (mm)						Insert	Price
		h	b	f	L	L1	kg		
AP547	SVJBR 1010 J11-F-1K	10	10	10	110	30	0,72	VBMT 1103	64 €
AP548	SVJBR 1212 J11-F-1K	12	12	12	110	32	0,105	ISO.	64 €
AP549	SVJBR 1616 H11-F-1K	16	16	16	100	35	0,160		66 €

Code	TC061 M2,5x6,5	T8
AP547 - AP549	TC061 M2,5x6,5	T8

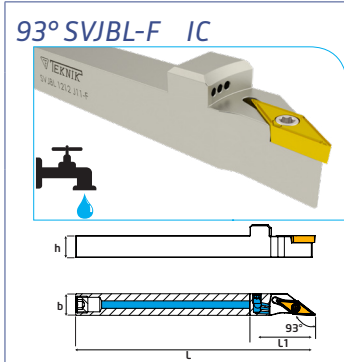

Order Code	Product Code	Dimensions (mm)						Insert	Price
		L	L1	h	f	b			
AP557	SVJBL 1010 J11-F-İK	110	30	10	10	10	0,72	VBMT 1103	64€
AP558	SVJBL 1212 J11-F-İK	110	32	12	12	12	0,105	ISO.	64€
<b>Code</b>									
AP557-AP558		TC061 M2,5x6,5		T8					

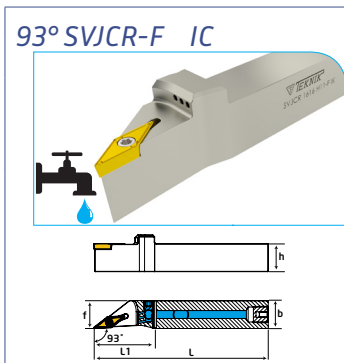

Order Code	Product Code	Dimensions (mm)						Insert	Price
		L	L1	h	f	b			
AP527	SVJCR 1212 J11-F-İK	110	32	12	12	12	0,102	VCMT 1103	64€
AP528	SVJCR 1616 H11-F-İK	100	35	16	16	16	0,185	ISO.	66€
<b>Code</b>									
AP527-AP528		TC061 M2,5x6,5		T8					

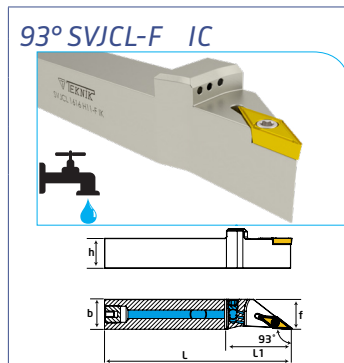

Order Code	Product Code	Dimensions (mm)						Insert	Price
		L	L1	h	f	b			
AP537	SVJCL 1212 J11-F-İK	110	32	12	12	12	0,102	VCMT 1103	64€
AP538	SVJCL 1616 H11-F-İK	100	35	16	16	16	0,185	ISO.	66€
<b>Code</b>									
AP537-AP538		TC061 M2,5x6,5		T8					

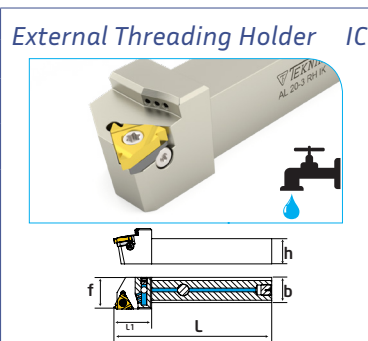

Order Code	Product Code	Dimensions (mm)					Insert	Price	
		h	b	f	L	L1			
AP602	SER 2020 K16 - ER16 İK	20	20	20	125	30	0,449	16 ER	77€
AP604	SER 2525 M16 - ER16 İK	25	25	25	150	30	0,842		81€
TC068 M3,5x11		TA061		TA060		TC062 M3		T15	



# EXTERNAL TURNING HOLDERS COOLANT

Technical Solution  
for quality

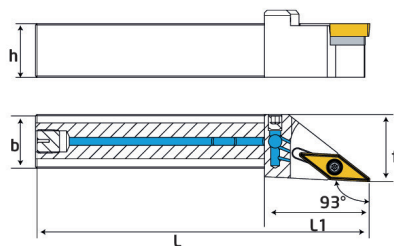
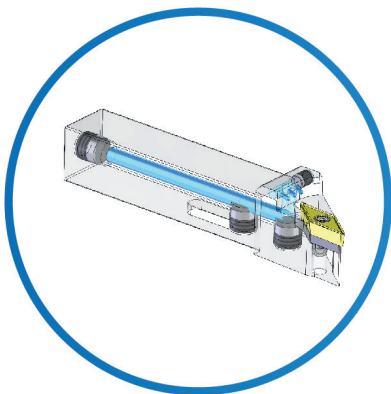
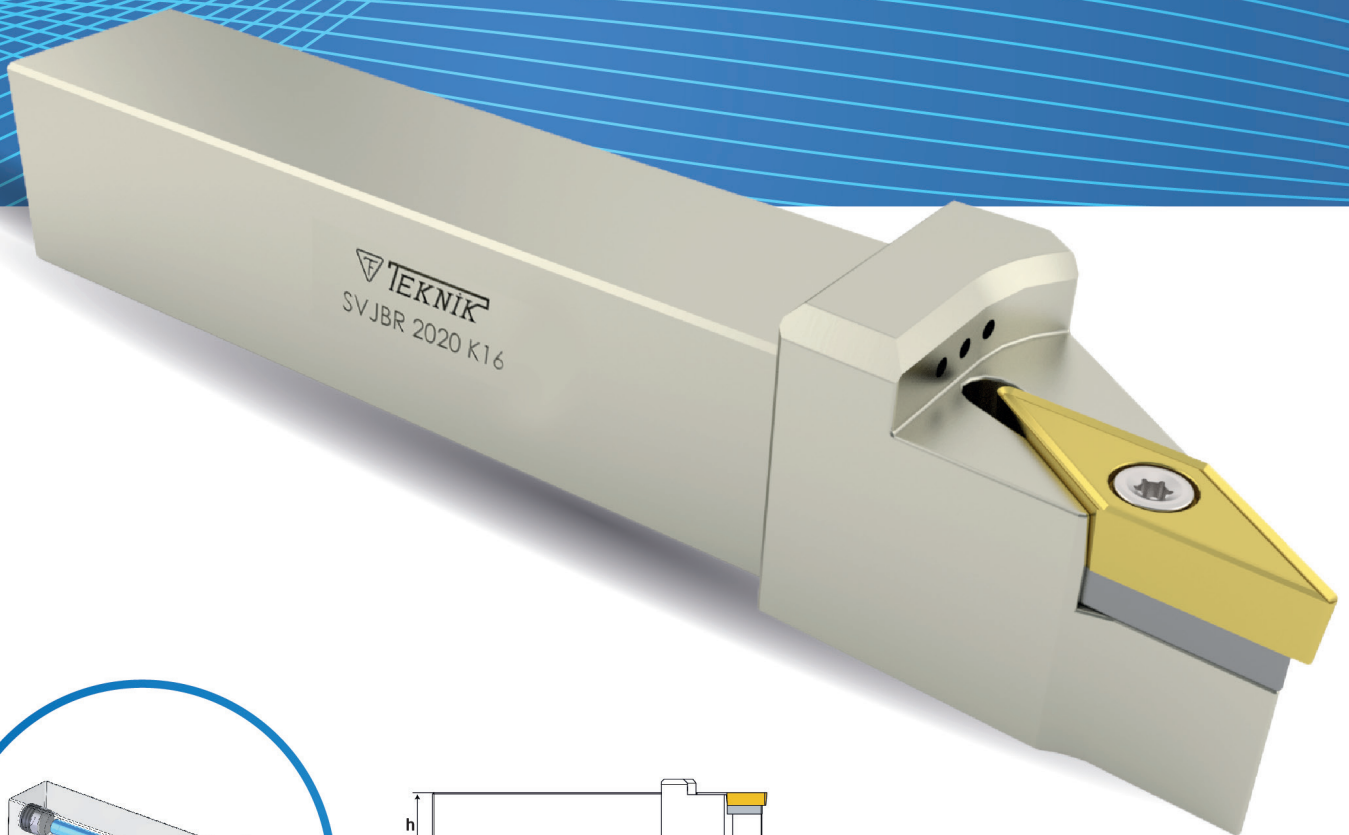

## P System External Turning Holder



[www.teknikcuttingtools.com](http://www.teknikcuttingtools.com)



Kalite için TEKNIK çözüm

Technical solution for quality

78-79



### 93° PDJNR

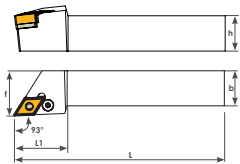
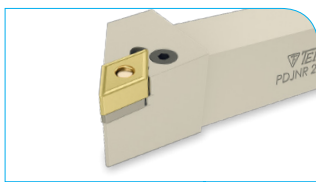

Order Code	Product Code	Dimensions (mm)						Insert	Price
		L	L1	h	f	b	kg		
P107	PDJNR 1616 H11	100	25	16	25	16	0,242	DNMG 1104	47 €
P108	PDJNR 2020 K11	125	30	20	25	20	0,435	ISO.	47 €
P109	PDJNR 2525 M11	150	30	25	32	25	0,767		48 €
P110	PDJNR 2020 K15	125	35	20	25	20	0,402		47 €
P112	PDJNR 2525 M15	150	38	25	32	25	0,730	DNMG 1506	48 €
P114	PDJNR 3232 P15	170	38	32	40	32	1,384	ISO.	56 €

Code	Insert	Holder	Wedge	Locking Bolt	Locking Key
P107	TH613	TA013	TS-3	TL3	2,5 Allen
P108-P109	TH617				
P110	TH822	TA014-1	TS-4	TL4B	3 Allen
P112-P114	TH825				

### 93° PDJNL

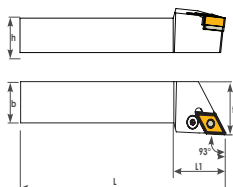
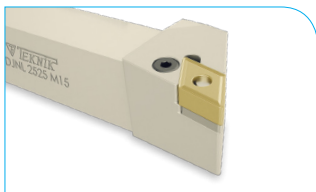

Order Code	Product Code	Dimensions (mm)						Insert	Price
		L	L1	h	f	b	kg		
P119	PDJNL 1616 H11	100	25	16	25	16	0,242	DNMG 1104	47 €
P120	PDJNL 2020 K11	125	30	20	25	20	0,435	ISO.	47 €
P121	PDJNL 2525 M11	150	30	25	32	25	0,767		48 €
P122	PDJNL 2020 K15	125	35	20	25	20	0,402		47 €
P124	PDJNL 2525 M15	150	38	25	32	25	0,730	DNMG 1506	48 €
P126	PDJNL 3232 P15	170	38	32	40	32	1,384	ISO.	56 €

Code	Insert	Holder	Wedge	Locking Bolt	Locking Key
P119	TH613	TA013	TS-3	TL3	2,5 Allen
P120-P121	TH617				
P122	TH822	TA014-1	TS-4	TL4B	3 Allen
P124-P126	TH825				

### 95° PCLNR

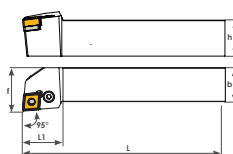

Order Code	Product Code	Dimensions (mm)						Insert	Price
		L	L1	h	f	b	kg		
P126-1	PCLNR 1616 H09	100	20	16	20	16	0,231	CNMG 09T3	47 €
P127	PCLNR 2020 K09	125	22	20	25	20	0,428	ISO.	47 €
P128	PCLNR 2525 M09	150	22	25	32	25	0,785		48 €
P129	PCLNR 1616 H12	100	30	16	20	16	0,225		47 €
P130	PCLNR 2020 K12	125	30	20	25	20	0,421	CNMG 1204	47 €
P132	PCLNR 2525 M12	150	30	25	32	25	0,766	ISO.	48 €
P134	PCLNR 3232 P12	170	30	32	40	32	1,429		56 €

Code	Insert	Holder	Wedge	Locking Bolt	Locking Key
(P126-1)-(P128)	TH617	TA023	TS3	TL3	2,5 Allen
P129	TH818				
P130-134	TH821	TA016-1	TS4	TL4	3 Allen

### 95° PCLNL

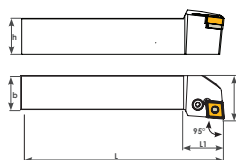
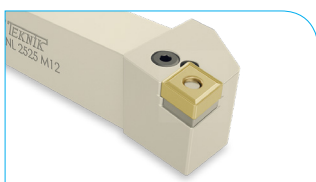

Order Code	Product Code	Dimensions (mm)						Insert	Price
		L	L1	h	f	b	kg		
P136	PCLNL 1616 H09	100	20	16	20	16	0,231	CNMG 09T3	47 €
P137	PCLNL 2020 K09	125	22	20	25	20	0,428	ISO.	47 €
P138	PCLNL 2525 M09	150	22	25	32	25	0,785		48 €
P139	PCLNL 1616 H12	100	30	16	20	16	0,225		47 €
P140	PCLNL 2020 K12	125	30	20	25	20	0,421	CNMG 1204	47 €
P142	PCLNL 2525 M12	150	30	25	32	25	0,766	ISO.	48 €
P144	PCLNL 3232 P12	170	30	32	40	32	1,429		56 €

Code	Insert	Holder	Wedge	Locking Bolt	Locking Key
P136-P138	TH617	TA023	TS3	TL3	2,5 Allen
P139	TH818				
P140-144	TH821	TA016-1	TS4	TL4	3 Allen

95° PWLNR 08

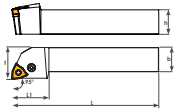

Order Code	Product Code	Dimensions (mm)						Insert	Price
		L	L1	h	f	b	kg		
P150	PWLNR 2020 K08	125	30	20	25	20	0,430		47 €
P151	PWLNR 2525 M08	150	38	25	32	25	0,773	WNMG 0804	48 €
P152	PWLNR 3232 P08	170	38	32	40	32	1,421	ISO.	56 €

TH821	TA020-1	TS4	TL4	3 Allen	

95° PWLNL 08

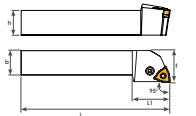

Order Code	Product Code	Dimensions (mm)						Insert	Price
		L	L1	h	f	b	kg		
P155	PWLNL 2020 K08	125	30	20	25	20	0,430		47 €
P156	PWLNL 2525 M08	150	38	25	32	25	0,773	WNMG 0804	48 €
P157	PWLNL 3232 P08	170	38	32	40	32	1,421	ISO.	56 €

TH821	TA020-1	TS4	TL4	3 Allen	

95° PWLNR 06

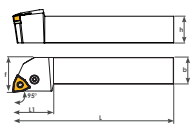

Order Code	Product Code	Dimensions (mm)						Insert	Price
		L	L1	h	f	b	kg		
P158	PWLNR 1616 H06	100	30	16	20	16	0,223		47 €
P160	PWLNR 2020 K06	125	30	20	25	20	0,429	WNMG 0604	47 €
P161	PWLNR 2525 M06	150	30	25	32	25	0,758	ISO.	48 €

TH617	TA021	TS3	TL3	2,5 Allen	

95° PWLNL 06

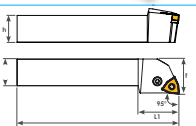
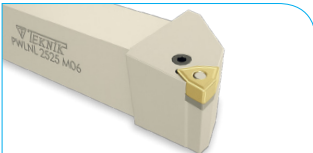

Order Code	Product Code	Dimensions (mm)						Insert	Price
		L	L1	h	f	b	kg		
P164	PWLNL 1616 H06	100	30	16	20	16	0,223		47 €
P165	PWLNL 2020 K06	125	30	20	25	20	0,429	WNMG 0604	47 €
P166	PWLNL 2525 M06	150	30	25	32	25	0,758	ISO.	48 €

TH617	TA021	TS3	TL3	2,5 Allen	

45° PSSNR

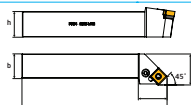
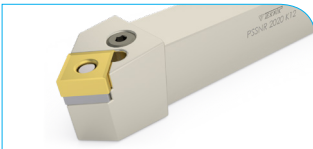

Order Code	Product Code	Dimensions (mm)						Insert	Price
		L	L1	h	f	b	kg		
P170	PSSNR 1616 H12	100	30	16	20	16	0,218		47 €
P171	PSSNR 2020 K12	125	30	20	25	20	0,416	SNMG 1204	47 €
P172	PSSNR 2525 M12	150	30	25	32	25	0,742	ISO.	48 €

<b>Code</b>						
P170	TH818	TA050	TS4	TL4	3 Allen	
P171-P172	TH821					

45° PSSNL

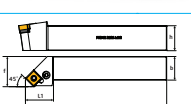

Order Code	Product Code	Dimensions (mm)						Insert	Price
		L	L1	h	f	b	kg		
P180	PSSNL 1616 H12	100	30	16	20	16	0,218		47 €
P181	PSSNL 2020 K12	125	30	20	25	20	0,416	SNMG 1204	47 €
P182	PSSNL 2525 M12	150	30	25	32	25	0,742	ISO.	48 €

<b>Code</b>						
P180	TH818	TA050	TS4	TL4	3 Allen	
P181-P182	TH821					

**TEKNIK**

» ÇALIŞKAN »  
« TEKNOLOJİ «

[www.teknikcuttingtools.com](http://www.teknikcuttingtools.com)





## D-M-C System External Turning Holders

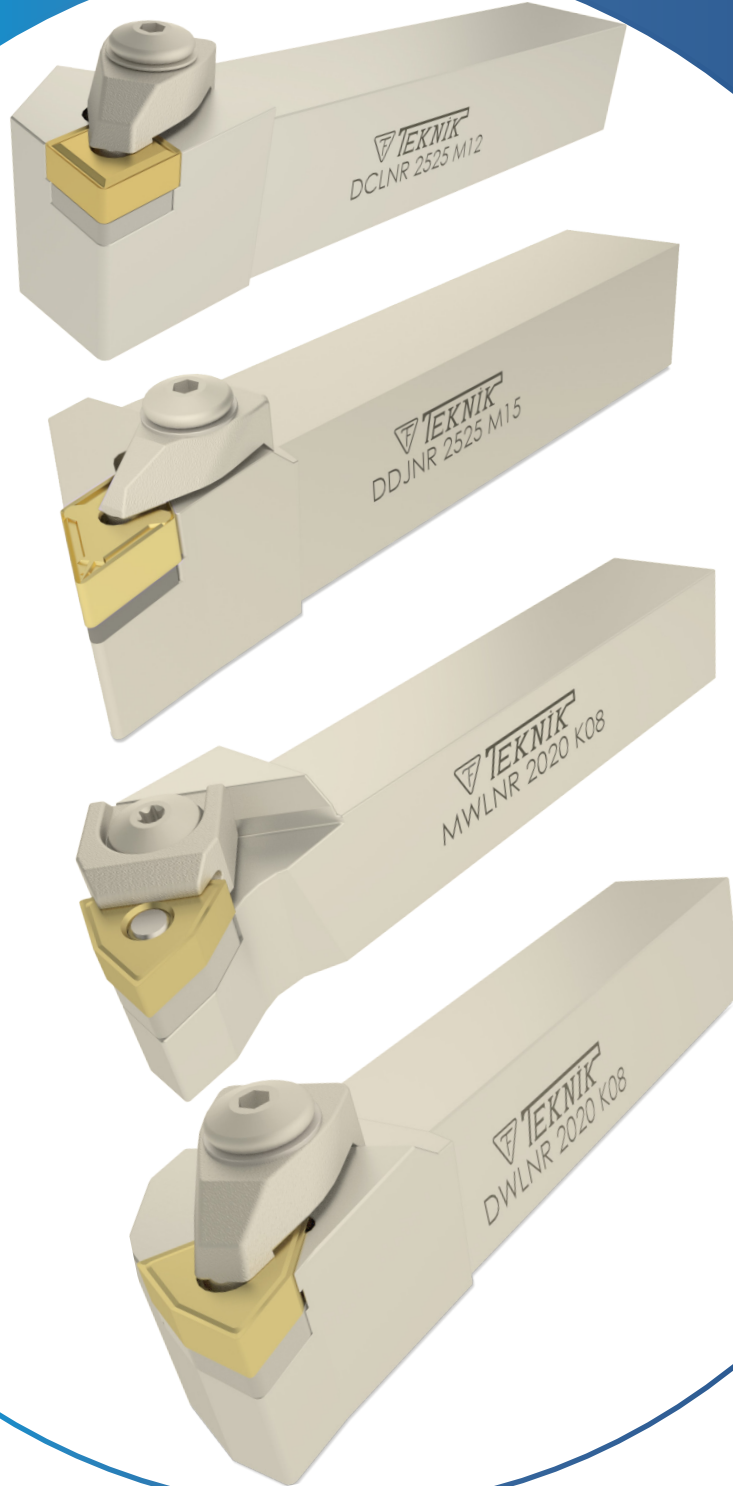

[www.teknikcuttingtools.com](http://www.teknikcuttingtools.com)



Kalite için TEKNİK çözüm

Technical solution for quality

82-87



93° DDJNR

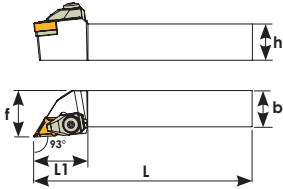
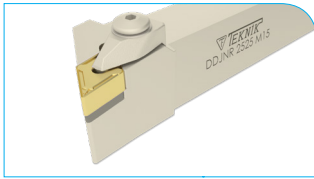

Order Code	Product Code	Dimensions (mm)						Insert	Price
		L	L1	h	f	b			
D167	DDJNR 2020 K11	125	30	20	25	20	0,421	DNMG 1104	47 €
D168	DDJNR 2525 M11	150	30	25	32	25	0,751	ISO.	48 €
D170	DDJNR 2020 K15	125	35	20	25	20	0,425		47 €
D172	DDJNR 2525 M15	150	35	25	32	25	0,756	DNMG 1506	48 €
D174	DDJNR 3232 P15	170	35	32	40	32	1,345	ISO.	56 €

Code								
D167 - D168	TC046 M5	TA013	TC034 M3x7	BK024	BY041	BSP031	3 Allen	
D170 - D174	TC044 M6	TA014-1	TC038 M4x10	BK020	BY040	BSP030	3 Allen	

93° DDJNL

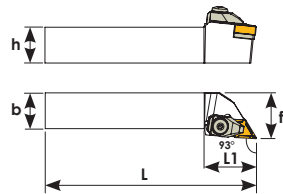
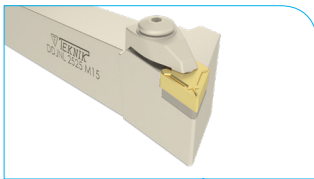

Order Code	Product Code	Dimensions (mm)						Insert	Price
		L	L1	h	f	b			
D307-1	DDJNL 2020 K11	125	30	20	25	20	0,421	DNMG 1104	47 €
D308	DDJNL 2525 M11	150	30	25	32	25	0,751	ISO.	48 €
D310	DDJNL 2020 K15	125	35	20	25	20	0,425		47 €
D312	DDJNL 2525 M15	150	35	25	32	25	0,756	DNMG 1506	48 €
D314	DDJNL 3232 P15	170	35	32	40	32	1,345	ISO.	56 €

Code								
D307-1 - D308	TC046 M5	TA013	TC034 M3x7	BK024	BY041	BSP031	3 Allen	
D310 - D314	TC044 M6	TA014-1	TC038 M4x10	BK020	BY040	BSP030	3 Allen	

93° DDJNR

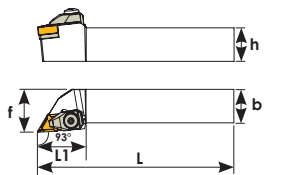
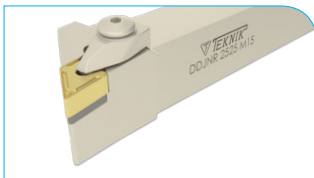

Order Code	Product Code	Dimensions (mm)						Insert	Price
		L	L1	h	f	b			
D171	DDJNR 2020 K15	125	38	20	25	20	0,426	DNMG 1504	47 €
D169	DDJNR 2525 M15	150	38	25	32	25	0,763	ISO.	48 €

Code								
	TC044 M6	TA014-1	TC038 M4x10	BK020	BY040	BSP030	3 Allen	

93° DDJNL

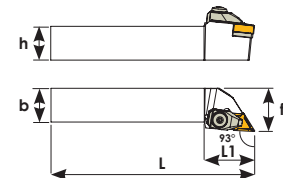
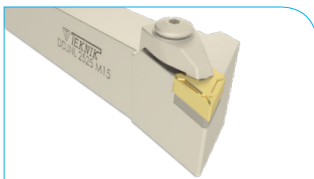

Order Code	Product Code	Dimensions (mm)						Insert	Price
		L	L1	h	f	b			
D313	DDJNL 2020 K15	125	38	20	25	20	0,426	DNMG 1504	47 €
D309	DDJNL 2525 M15	150	38	25	32	25	0,763	ISO.	48 €

Code								
	TC044 M6	TA014-1	TC038 M4x10	BK020	BY040	BSP030	3 Allen	

107,5° DDHNR

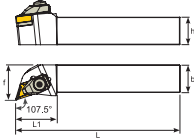

Order Code	Product Code	Dimensions (mm)						Insert	Price
		L	L1	h	f	b			
D096	DDHNR 2020 K15	125	33	20	25	20	0,428		47 €
D097	DDHNR 2525 M15	150	33	25	32	25	0,753	DNMG 1506	48 €
D098	DDHNR 3232 P15	170	33	32	40	32	1,290	ISO.	56 €

TC044 M6	TA014-1	TC038 M4x10	BK020	BY040	BSP030	3 Allen	

107,5° DDHNL

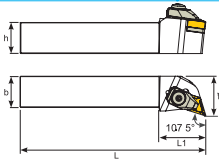

Order Code	Product Code	Dimensions (mm)						Insert	Price
		L	L1	h	f	b			
D295	DDHNL 2020 K15	125	33	20	25	20	0,428		47 €
D296	DDHNL 2525 M15	150	33	25	32	25	0,753	DNMG 1506	48 €
D297	DDHNL 3232 P15	170	33	32	40	32	1,290	ISO.	56 €

TC044 M6	TA014-1	TC038 M4x10	BK020	BY040	BSP030	3 Allen	

62,5° DDNNN

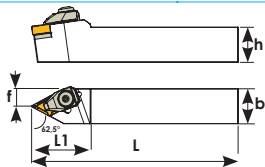
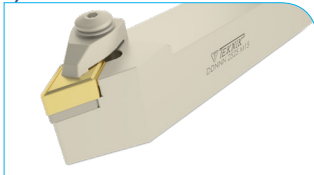

Order Code	Product Code	Dimensions (mm)						Insert	Price
		L	L1	h	f	b			
D104	DDNNN 2020 K15	125	40	20	10	20	0,404		47 €
D106	DDNNN 2525 M15	150	40	25	12,5	25	0,724	DNMG 1506	48 €
D109	DDNNN 3232 P15	170	40	32	16	32	1,290	ISO.	56 €

TC044 M6	TA014-1	TC038 M4x10	BK020	BY040	BSP030	3 Allen	

95° DCLNR

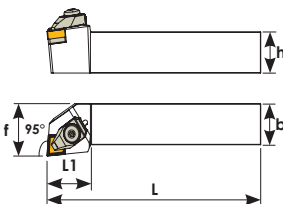
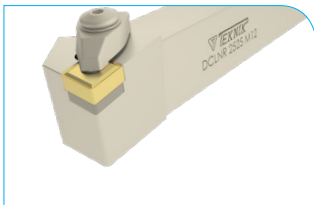

Order Code	Product Code	Dimensions (mm)						Insert	Price
		L	L1	h	f	b			
D160	DCLNR 2020 K12	125	30	20	25	20	0,441	CNMG 1204	47 €
D162	DCLNR 2525 M12	150	30	25	32	25	0,785	ISO.	48 €
D164	DCLNR 3232 P12	170	30	32	40	32	1,379		56 €
D162-1	DCLNR 2525 M16	150	36	25	32	25	0,432	CNMG 1606	54 €
D165	DCLNR 3232 P16	170	36	32	40	32	1,407	ISO.	58 €
D163	DCLNR 2525 M19	150	40	25	32	25	0,820	CNMG 1906	58 €
D166	DCLNR 3232 P19	170	40	32	40	32	1,430	ISO.	65 €
D166-1	DCLNR 4040 S19	250	40	40	40	40	3,195		88 €

<b>Code</b>								
D160 - D164	TC044 M6	TA016-1	TC038 M4x10	BK020	BY040	BSP030	3 Allen	
D162-1 - D165		TA022	TC095 M5x11,8	BK018				
D163 - D166-1	TC047 M8	TA017	TC039 M6x12	BK025	BY044	BSP032	5 Allen	

95° DCLNL

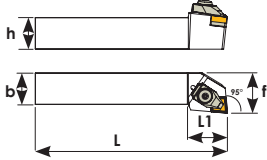
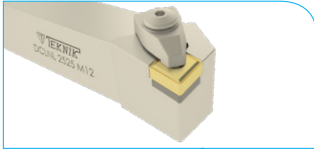

Order Code	Product Code	Dimensions (mm)						Insert	Price
		L	L1	h	f	b			
D301	DCLNL 2020 K12	125	30	20	25	20	0,441	CNMG 1204	47 €
D302	DCLNL 2525 M12	150	30	25	32	25	0,785	ISO.	48 €
D305	DCLNL 3232 P12	170	30	32	40	32	1,379		56 €
D303	DCLNL 2525 M16	150	36	25	32	25	0,432	CNMG 1606	54 €
D306	DCLNL 3232 P16	170	36	32	40	32	1,407	ISO.	58 €
D304	DCLNL 2525 M19	150	40	25	32	25	0,820	CNMG 1906	58 €
D307	DCLNL 3232 P19	170	40	32	40	32	1,430	ISO.	65 €
D307-2	DCLNL 4040 S19	250	40	40	40	40	3,195		88 €

Code								
D301 - D305	TC044 M6	TA016-1	TC038 M4x10	BK020	BY040	BSP030	3 Allen	
D303 - D306		TA022	TC095 M5x11,8	BK018				
D304 - D307-2	TC047 M8	TA017	TC039 M6x12	BK025	BY044	BSP032	5 Allen	

50° DCMNN

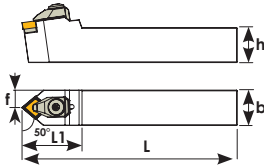
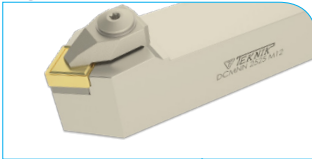

Order Code	Product Code	Dimensions (mm)						Insert	Price
		L	L1	h	f	b			
D214-1	DCMNN 2020 K12	125	35	20	10	20	0,445	CNMG 1204 ISO.	47 €
D215	DCMNN 2525 M12	150	35	25	12,5	25	0,778		48 €

Code								
	TC044 M6	TA016-1	TC038 M4x10	BK020	BY040	BSP030	3 Allen	

40° DCXNN

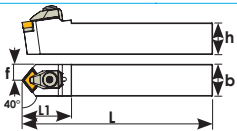
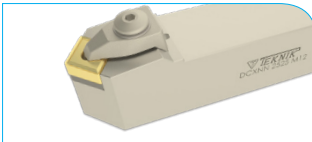

Order Code	Product Code	Dimensions (mm)						Insert	Price
		L	L1	h	f	b			
D216	DCXNN 2525 M12	150	35	25	12,5	25	0,756	CNMG 1204 ISO.	48 €

Code								
	TC044 M6	TA016-1	TC038 M4x10	BK020	BY040	BSP030	3 Allen	

75° DCKNR

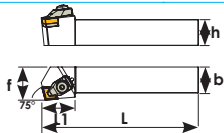
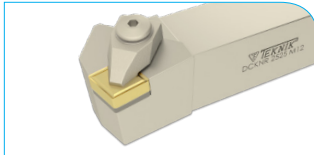

Order Code	Product Code	Dimensions (mm)						Insert	Price
		L	L1	h	f	b			
D116-1	DCKNR 2525 M12	150	30	25	32	25	0,440	CNMG 1204 ISO	48 €
D162-3	DCKNR 2525 M16	150	40	25	32	25	0,576	CNMG 1606 ISO.	54 €

Code								
D116-1	TC044 M6	TA016-1	TC038 M4x10	BK020	BY040	BSP030	3 Allen	
D162-3		TA022	TC095 M5x11,8	BK018				

45° DCSNR

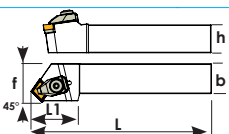

Order Code	Product Code	Dimensions (mm)						Insert	Price
		L	L1	h	f	b			
D218	DCSNR 2525 M12	150	35	25	32	25	0,774	CNMG 1204 ISO.	48 €

Code								
	TC044 M6	TA016-1	TC038 M4x10	BK020	BY040	BSP030	3 Allen	

45° DSSNR

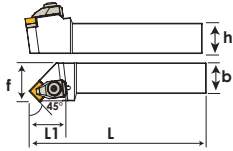
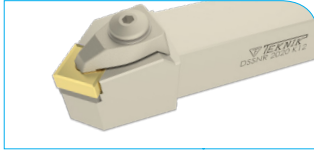

Order Code	Product Code	Dimensions (mm)						Insert	Price
		L	L1	h	f	b	kg		
D210	DSSNR 2020 K12	125	35	20	25	20	0,440	SNMG 1204	47 €
D212	DSSNR 2525 M12	150	35	25	32	25	0,576	ISO.	48 €
D205	DSSNR 3232 P12	170	36	32	32	40	1,280		56 €
D206	DSSNR 3232 P19	170	46	32	32	40	1,383	SNMG 1906	72 €
D207	DSSNR 4040 S19	250	46	40	40	50	3,123	ISO.	88 €
D208	DSSNR 4040 S25	250	60	40	40	50	3,012	SNMG 2508	105 €

Code							
D210-D205	TC044 M6	TA050	TC038 M4x10	BK020	BY040	BSP030	3 Allen
D206-D207	TC047 M8	TA051	TC039 M6x12	BK025	BY044	BSP032	5 Allen
D208	TC047 M8	TA053	TC041 M8x20	BK027	BY044	BSP032	5 Allen

95° DWLNR

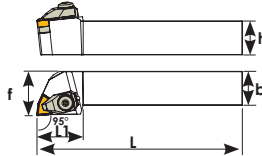
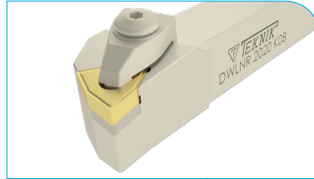

Order Code	Product Code	Dimensions (mm)						Insert	Price
		L	L1	h	f	b	kg		
D181	DWLNR 1616 H06	100	26	16	20	16	0,229		47 €
D177	DWLNR 2020 K06	125	26	20	25	20	0,436	WNMG 0604	47 €
D179	DWLNR 2525 M06	150	26	25	32	25	0,772	ISO.	48 €
D176	DWLNR 2020 K08	125	32	20	25	20	0,442		47 €
D178	DWLNR 2525 M08	150	32	25	32	25	0,793	WNMG 0804	48 €
D180	DWLNR 3232 P08	170	32	32	40	32	1,377	ISO.	56 €

Code							
D181 - D179	TC046 M5	TA021	TC034 M3x7	BK024	BY041	BSP031	3 Allen
D176 - D180	TC044 M6	TA020-1	TC038 M5x12	BK020	BY040	BSP030	3 Allen

95° DWLNL

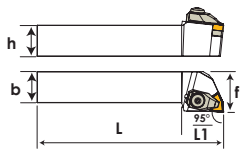

Order Code	Product Code	Dimensions (mm)						Insert	Price
		L	L1	h	f	b	kg		
D328	DWLNL 1616 H06	100	26	16	20	16	0,229	WNMG 0604	47 €
D329	DWLNL 2020 K06	125	26	20	25	20	0,436	ISO.	47 €
D319	DWLNL 2525 M06	150	26	25	32	25	0,772		48 €
D316	DWLNL 2020 K08	125	32	20	25	20	0,442	WNMG 0804	47 €
D318	DWLNL 2525 M08	150	32	25	32	25	0,793	ISO.	48 €
D320	DWLNL 3232 P08	170	32	32	40	32	1,377		56 €

Code							
D328 - D319	TC046 M5	TA021	TC034 M3x7	BK024	BY041	BSP031	3 Allen
D316 - D320	TC044 M6	TA020-1	TC038 M5x12	BK020	BY040	BSP030	3 Allen

95° MWLNR

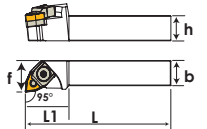

Order Code	Product Code	Dimensions (mm)						Insert	Price
		L	L1	h	f	b	kg		
D182	MWLNR 2020 K08	125	32	20	25	20	0,435		47 €
D184	MWLNR 2525 M08	150	32	25	32	25	0,761	WNMG 0804	48 €
D185	MWLNR 3232 P08	170	32	32	40	32	1,349	ISO.	56 €

Code							
TC044 M6	TA020	BSP021	BK026	BY040	BSP030	3 Allen	

95° MWLNL

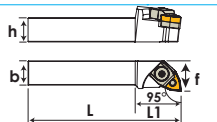
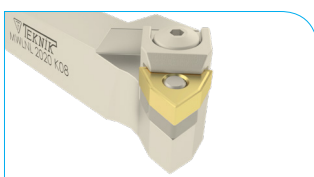

Order Code	Product Code	Dimensions (mm)						Insert	Price
		L	L1	h	f	b	kg		
D322	MWLNL 2020 K08	125	32	20	25	20	0,435		47 €
D324	MWLNL 2525 M08	150	32	25	32	25	0,761	WNMG 0804	48 €
D326	MWLNL 3232 P08	170	32	32	40	32	1,349	ISO.	56 €

Code							
TC044 M6	TA020	BSP021	BK026	BY040	BSP030	3 Allen	

### 95 MWMNN

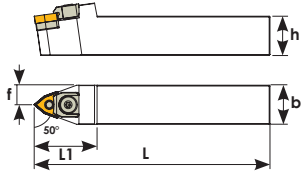
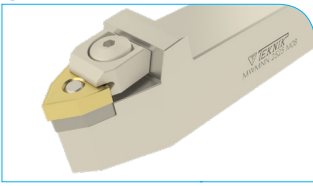

Order Code	Product Code	Dimensions (mm)						Insert	Price
		L	L1	h	f	b			
D114	MWMNN 2020 K08	125	40	20	10	20	0,432	WNMG 0804	47 €
D116	MWMNN 2525 M08	150	40	25	12.5	25	0,724	ISO.	48 €

TC044 M6	TA020	BSP021	BK026	BY040	BSP030	3 Allen	

### 93° MTJNR

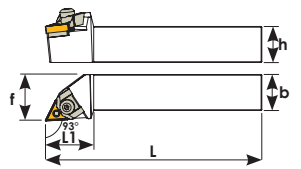
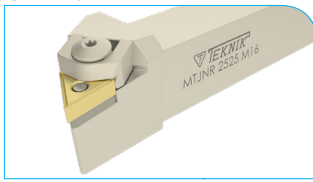

Order Code	Product Code	Dimensions (mm)						Insert	Price
		L	L1	h	f	b			
D194	MTJNR 2020 K16	125	35	20	25	20	0,429	TNMG 1604	47 €
D196	MTJNR 2525 M16	150	35	25	32	25	0,760	ISO.	48 €
D198	MTJNR 3232 P16	170	35	32	40	32	1,360		56 €
D200	MTJNR 2020 K22	125	37	20	25	20	0,429	TNMG 2204	47 €
D202	MTJNR 2525 M22	150	40	25	32	25	0,775	ISO.	48 €
D204	MTJNR 3232 P22	170	40	32	40	32	1,348		56 €

<b>Code</b>								
D194 - D198	TC046 M5	TA019	BSP020	BK022	BY043	BSP031	3 Allen	
D200 - D204	TC044 M6	TA045	BSP021	BK023	BY040	BSP030	3 Allen	

### 93° MTJNL

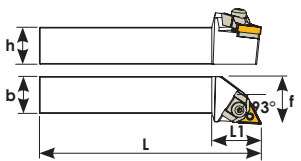

Order Code	Product Code	Dimensions (mm)						Insert	Price
		L	L1	h	f	b			
D332	MTJNL 2020 K16	125	35	20	25	20	0,429		47 €
D334	MTJNL 2525 M16	150	35	25	32	25	0,760	TNMG 1604	48 €
D336	MTJNL 3232 P16	170	35	32	40	32	1,360	ISO.	56 €
D338	MTJNL 2020 K22	125	37	20	25	20	0,429	TNMG 2204	47 €
D340	MTJNL 2525 M22	150	40	25	32	25	0,775	ISO.	48 €
D342	MTJNL 3232 P22	170	40	32	40	32	1,348		56 €

<b>Code</b>								
D332 - D336	TC046 M5	TA019	BSP020	BK022	BY043	BSP031	3 Allen	
D338 - D342	TC044 M6	TA045	BSP021	BK023	BY040	BSP030	3 Allen	

### 60° MTENN

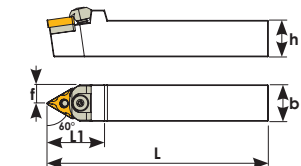

Order Code	Product Code	Dimensions (mm)						Insert	Price
		L	L1	h	f	b			
D108	MTENN 2020 K16	125	35	20	10	20	0,408	TNMG 1604	47 €
D110	MTENN 2525 M16	150	35	25	12.5	25	0,724	ISO.	48 €
D112	MTENN 2525 M22	150	40	25	12.5	25	0,734	TNMG 2204	48 €
D113	MTENN 3232 P22	170	40	32	16	32	1,311	ISO.	56 €

<b>Code</b>								
D108 - D110	TC046 M5	TA019	BSP020	BK022	BY043	BSP031	3 Allen	
D112 - D113	TC044 M6	TA045	BSP021	BK023	BY040	BSP030	3 Allen	

93° DVJNR

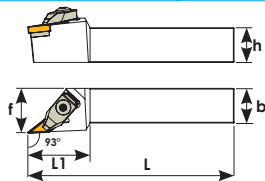

Order Code	Product Code	Dimensions (mm)						Insert	Price
		L	L1	h	f	b			
D105-1	DVJNR 2020 K16	125	40	20	27	20	0,428	VNMG 1604	47 €
D105	DVJNR 2525 M16	150	40	25	32	25	0,427	ISO.	48 €

TC046 M5	TA033	TC074 M4x10	BK021	BY043	BSP031	3 Allen	

93° DVJNL

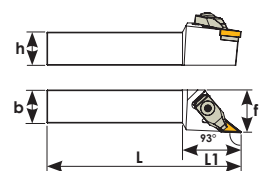
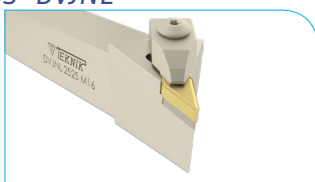

Order Code	Product Code	Dimensions (mm)						Insert	Price
		L	L1	h	f	b			
D343	DVJNL 2020 K16	125	40	20	27	20	0,428	VNMG 1604	47 €
D344	DVJNL 2525 M16	150	40	25	32	25	0,427	ISO.	48 €

TC046 M5	TA033	TC074 M4x10	BK021	BY043	BSP031	3 Allen	

72,5° DVVNN

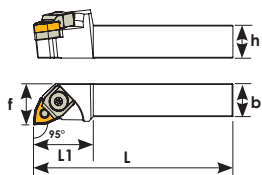
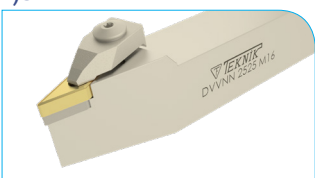

Order Code	Product Code	Dimensions (mm)						Insert	Price
		L	L1	h	f	b			
D105-2	DVVNN 2525 M16	150	45	25	12,5	25	0,690	VNMG 1604	48 €

TC046 M5	TA033	TC074 M4x10	BK021	BY043	BSP031	3 Allen	

93° CKJNR

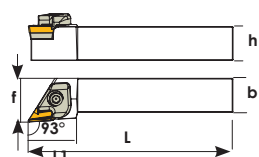

Order Code	Product Code	Dimensions (mm)						Insert	Price
		L	L1	h	f	b			
RD018	CKJNR 2020 K16	125	32	20	27	20	0,434	KNUX 1604	47 €
RD014	CKJNR 2525 M16	150	35	25	30	25	0,753	ISO.	48 €
RD013	CKJNR 3232 P16	170	35	32	40	32	1,311		56 €

TC044 M6	TA046	TC036 M3x10	BK028	BY042	BSP030	3 Allen	

Kalite için **TEKNIK** çözüm  
Technical solution for quality

THE **TEKNIK MAKİNA**®  
**EXCEPTIONAL**  
**CUTTING TOOLS**  
COLLECTION

**TEKNIK**

[www.teknikmakinatakim.com](http://www.teknikmakinatakim.com)





## S System External Turning Holder



[www.teknikcuttingtools.com](http://www.teknikcuttingtools.com)



Kalite için TEKNİK çözüm

Technical solution for quality

90-96



95° SCLCR

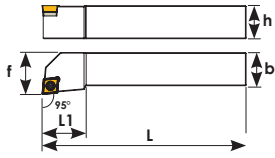
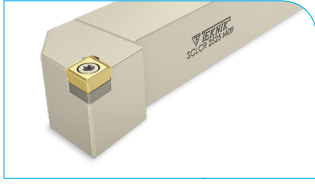

Order Code	Product Code	Dimensions (mm)						Insert	Price
		L	L1	h	f	b			
D398	SCLCR 1010 J06	110	10	10	12	10	0,105	CCMT 0602 ISO.	32 €
D400	SCLCR 1212 J09	110	16	12	16	12	0,140		32 €
D401	SCLCR 1616 H09	100	20	16	20	16	0,215	CCMT 09T3	35 €
D402	SCLCR 2020 K09	125	25	20	25	20	0,425	ISO.	36 €
D403	SCLCR 2525 M09	150	25	25	32	25	0,772		37 €
D418	SCLCR 2020 K12	125	25	20	25	20	0,421	CCMT 1204	41 €
D403-1	SCLCR 2525 M12	150	25	25	32	25	0,768	ISO.	42 €

Code				
D398	TC060 M2,5x5,5	--	--	T8
D400	TC067 M3,5x8,5	--	--	T15
D401-D403	TC068 M3,5x11	TA015	TC048 M5	T15
D418-D403-1	TC075 M4x11	TA015-1	TC049-1M6	T15

95° SCLCL

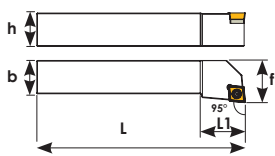
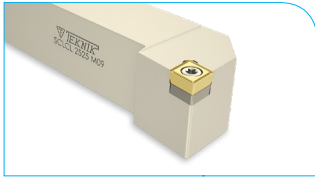

Order Code	Product Code	Dimensions (mm)						Insert	Price
		L	L1	h	f	b			
D404	SCLCL 1010 J06	110	10	10	12	10	0,105	CCMT 0602	32 €
D405	SCLCL 1212 J09	110	16	12	16	12	0,140	ISO.	32 €
D406	SCLCL 1616 H09	100	20	16	20	16	0,215	CCMT 09T3	35 €
D407	SCLCL 2020 K09	125	25	20	25	20	0,425	ISO.	36 €
D408	SCLCL 2525 M09	150	25	25	32	25	0,772		37 €
D420	SCLCL 2020 K12	125	25	20	25	20	0,421	CCMT 1204	41 €
D421	SCLCL 2525 M12	150	25	25	32	25	0,768	ISO.	42 €

Code				
D404	TC060 M2,5x5,5	--	--	T8
D405	TC067 M3,5x8,5	--	--	T15
D406-D408	TC068 M3,5x11	TA015	TC048 M5	T15
D420-D421	TC075 M4x11	TA015-1	TC049-1M6	T15

90° SCACR-F

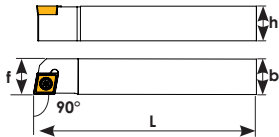
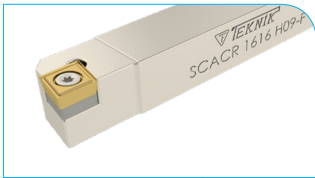

Order Code	Product Code	Dimensions (mm)				Insert	Price	
		L	h	f	b			
D411	SCACR 1010 J06-F	110	10	10	10	0,104	CCMT 0602 ISO	32 €
D412	SCACR 1212 J09-F	110	12	12	12	0,143		32 €
D414	SCACR 1616 H09-F	100	16	16	16	0,221	CCMT 09T3	35 €
D416	SCACR 2020 K09-F	125	20	20	20	0,420	ISO.	36 €

Code				
D411	TC060 M2,5x5,5	--	--	T8
D412	TC067 M3,5x11	--	--	T15
D414-D416	TC068 M3,5x11	TA015	TC048 M5	T15

95° SCLCR-F

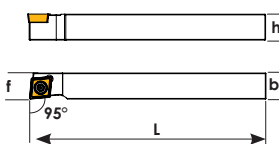
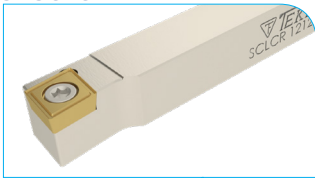

Order Code	Product Code	Dimensions (mm)				Insert	Price	
		L	h	f	b			
D422	SCLCR 1010 J06-F	110	10	10	10	0,106	CCMT 0602	32 €
D424	SCLCR 1212 J06-F	110	12	12	12	0,147	ISO.	32 €
D426	SCLCR 1212 J09-F	110	12	12	12	0,144	CCMT 09T3	35 €
D428	SCLCR 1616 H09-F	100	16	16	16	0,224	ISO.	36 €
D430	SCLCR 2020 K09-F	125	20	20	20	0,426		37 €

Code				
D422-D424	TC060 M2,5x5,5	--	--	T8
D426-D430	TC068 M3,5x11	--	--	T15
D428-D430	TC068 M3,5x11	TA015	TC048 M5	T15

93° SDJCR

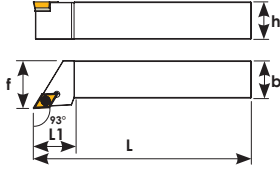
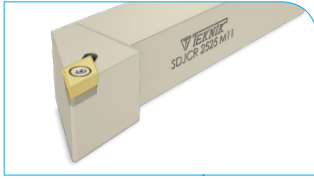

Order Code	Product Code	Dimensions (mm)						Insert	Price																														
		L	L1	h	f	b	kg																																
D220	SDJCR 1010 J07	110	15	10	12	10	0,097	DCMT 0702 ISO	32 €																														
D222	SDJCR 1212 J11	110	20	12	16	12	0,132		32 €																														
D224	SDJCR 1616 H11	100	25	16	20	16	0,204	DCMT 11T3	35 €																														
D226	SDJCR 2020 K11	125	25	20	25	20	0,404	ISO.	36 €																														
D228	SDJCR 2525 M11	150	30	25	32	25	0,735		37 €																														
<p><b>Code</b></p> <table border="0"> <tr> <td>D220</td> <td>TC060 M2,5x5,5</td> <td>---</td> <td></td> <td></td> <td></td> <td></td> <td></td> <td>T8</td> <td></td> </tr> <tr> <td>D222</td> <td>TC067 M3,5x8,5</td> <td>---</td> <td></td> <td></td> <td></td> <td></td> <td></td> <td></td> <td></td> </tr> <tr> <td>D224-D228</td> <td>TC068 M3,5x11</td> <td>TA030</td> <td></td> <td></td> <td>TC048 M5</td> <td></td> <td></td> <td>T15</td> <td></td> </tr> </table>										D220	TC060 M2,5x5,5	---						T8		D222	TC067 M3,5x8,5	---								D224-D228	TC068 M3,5x11	TA030			TC048 M5			T15	
D220	TC060 M2,5x5,5	---						T8																															
D222	TC067 M3,5x8,5	---																																					
D224-D228	TC068 M3,5x11	TA030			TC048 M5			T15																															

93° SDJCL

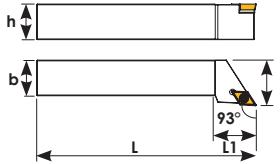
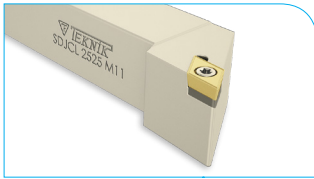

Order Code	Product Code	Dimensions (mm)						Insert	Price																														
		L	L1	h	f	b	kg																																
D360	SDJCL 1010 J07	110	15	10	12	10	0,097	DCMT 0702 ISO	32 €																														
D362	SDJCL 1212 J11	110	20	12	16	12	0,132		32 €																														
D364	SDJCL 1616 H11	100	25	16	20	16	0,204	DCMT 11T3	35 €																														
D366	SDJCL 2020 K11	125	25	20	25	20	0,404	ISO.	36 €																														
D368	SDJCL 2525 M11	150	30	25	32	25	0,735		37 €																														
<p><b>Code</b></p> <table border="0"> <tr> <td>D360</td> <td>TC060 M2,5x5,5</td> <td>---</td> <td></td> <td></td> <td></td> <td></td> <td></td> <td>T8</td> <td></td> </tr> <tr> <td>D362</td> <td>TC067 M3,5x8,5</td> <td>---</td> <td></td> <td></td> <td></td> <td></td> <td></td> <td></td> <td></td> </tr> <tr> <td>D366-D368</td> <td>TC068 M3,5x11</td> <td>TA030</td> <td></td> <td></td> <td>TC048 M5</td> <td></td> <td></td> <td>T15</td> <td></td> </tr> </table>										D360	TC060 M2,5x5,5	---						T8		D362	TC067 M3,5x8,5	---								D366-D368	TC068 M3,5x11	TA030			TC048 M5			T15	
D360	TC060 M2,5x5,5	---						T8																															
D362	TC067 M3,5x8,5	---																																					
D366-D368	TC068 M3,5x11	TA030			TC048 M5			T15																															

62,5° SDNCN

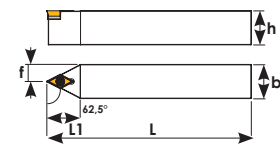

Order Code	Product Code	Dimensions (mm)						Insert	Price																														
		L	L1	h	f	b	kg																																
D117	SDNCN 1010 J07	110	15	10	5	10	0,096	DCMT 0702 ISO	32 €																														
D118	SDNCN 1212 J11	110	25	12	6	12	0,131		32 €																														
D120	SDNCN 1616 H11	100	25	16	8	16	0,196	DCMT 11T3	35 €																														
D122	SDNCN 2020 K11	125	25	20	10	20	0,390	ISO.	36 €																														
D124	SDNCN 2525 M11	150	25	25	12,5	25	0,705		37 €																														
<p><b>Code</b></p> <table border="0"> <tr> <td>D117</td> <td>TC060 M2,5x5,5</td> <td>---</td> <td></td> <td></td> <td></td> <td></td> <td></td> <td>T8</td> <td></td> </tr> <tr> <td>D118</td> <td>TC067 M3,5x8,5</td> <td>---</td> <td></td> <td></td> <td></td> <td></td> <td></td> <td></td> <td></td> </tr> <tr> <td>D120-D124</td> <td>TC068 M3,5x11</td> <td>TA030</td> <td></td> <td></td> <td>TC048 M5</td> <td></td> <td></td> <td>T15</td> <td></td> </tr> </table>										D117	TC060 M2,5x5,5	---						T8		D118	TC067 M3,5x8,5	---								D120-D124	TC068 M3,5x11	TA030			TC048 M5			T15	
D117	TC060 M2,5x5,5	---						T8																															
D118	TC067 M3,5x8,5	---																																					
D120-D124	TC068 M3,5x11	TA030			TC048 M5			T15																															

90° SDACR-F

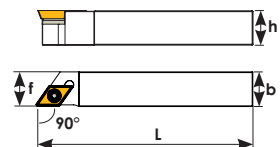

Order Code	Product Code	Dimensions (mm)					Insert	Price																															
		L	L1	h	f	kg																																	
D434	SDACR 1010 J07-F	110	10	10	10	0,970	DCMT 0702	32 €																															
D436	SDACR 1212 J07-F	110	12	12	12	0,135	ISO.	32 €																															
D438	SDACR 1616 H07-F	100	16	16	16	0,207		35 €																															
D440	SDACR 1212 J11-F	110	12	12	12	0,135		32 €																															
D442	SDACR 1616 H11-F	100	16	16	16	0,200	DCMT 11T3	35 €																															
D444	SDACR 2020 K11-F	125	20	20	20	0,397	ISO.	36 €																															
<p><b>Code</b></p> <table border="0"> <tr> <td>D434-D438</td> <td>TC060 M2,5x5,5</td> <td>---</td> <td></td> <td></td> <td></td> <td></td> <td></td> <td>T8</td> <td></td> </tr> <tr> <td>D440</td> <td>TC067 M3,5x8,5</td> <td>---</td> <td></td> <td></td> <td></td> <td></td> <td></td> <td></td> <td></td> </tr> <tr> <td>D442-D444</td> <td>TC067 M3,5x8,5</td> <td>TA030</td> <td></td> <td></td> <td>TC048 M5</td> <td></td> <td></td> <td>T15</td> <td></td> </tr> </table>										D434-D438	TC060 M2,5x5,5	---						T8		D440	TC067 M3,5x8,5	---								D442-D444	TC067 M3,5x8,5	TA030			TC048 M5			T15	
D434-D438	TC060 M2,5x5,5	---						T8																															
D440	TC067 M3,5x8,5	---																																					
D442-D444	TC067 M3,5x8,5	TA030			TC048 M5			T15																															

93° SDJCR-F



Order Code	Product Code	Dimensions (mm)					Insert	Price
		L	h	f	b			
D452	SDJCR 1010 J07-F	110	10	10	10	0,103	DCMT 0702	32 €
D454	SDJCR 1212 J07-F	110	12	12	12	0,131	ISO.	32 €
D456	SDJCR 1616 H07-F	100	16	16	16	0,192		35 €
D457	SDJCR 1212 J11-F	110	12	12	12	0,134	DCMT 11T3 ISO.	32 €
D458	SDJCR 1616 H11-F	100	16	16	16	0,181		35 €

Code						
D452-D456	TC060 M2,5x5,5	---	---	---	T8	
D457-D458	TC067 M3,5x8,5	---	---	---	T15	

93° SDJCL-F

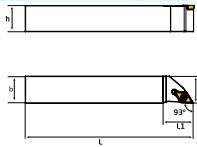

Order Code	Product Code	Dimensions (mm)					Insert	Price	
		L	L1	h	f	b			
D154	SDJCL 1212 K07-F	125	15	12	12	12	0,135	DCMT 0702	32 €
D155	SDJCL 1616 H07-F	100	18	16	16	16	0,152	ISO.	35 €
D156	SDJCL 1212 J11-F	110	20	12	12	12	0,134	DCMT 11T3	32 €
D157	SDJCL 1616 H11-F	100	25	16	16	16	0,180		35 €

Code						
D154-D155	TC060 M2,5x5,5	---	---	---	T8	
D156-D157	TC067 M3,5x8,5	TA030	---	TC048 M5	T15	

107,5° SDHCR

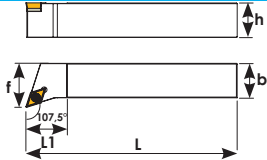
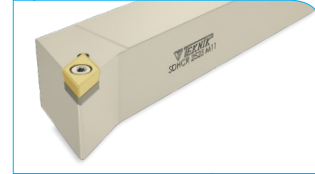

Order Code	Product Code	Dimensions (mm)					Insert	Price	
		L	L1	h	f	b			
D250	SDHCR 2020 K11	125	25	20	25	20	0,411	DCMT 11T3	36 €
D252	SDHCR 2525 M11	150	25	25	32	25	0,738	ISO.	37 €

Code						
D250-D252	TC068 M3,5x11	TA030	---	TC048 M5	T15	

107,5° SDHCL

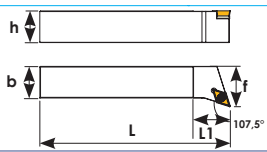
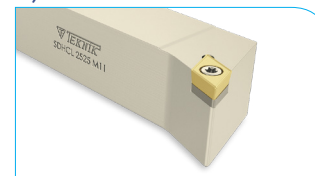

Order Code	Product Code	Dimensions (mm)					Insert	Price	
		L	L1	h	f	b			
D350	SDHCL 2020 K11	125	25	20	25	20	0,411	DCMT 11T3	36 €
D352	SDHCL 2525 M11	150	25	25	32	25	0,738	ISO.	37 €

Code						
D350-D352	TC068 M3,5x11	TA030	---	TC048 M5	T15	

93° SVJBR

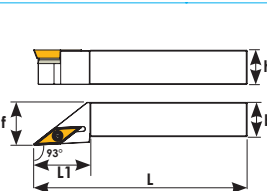

Order Code	Product Code	Dimensions (mm)					Insert	Price	
		L	L1	h	f	b			
D230	SVJBR 1010 J11	110	21	10	12	10	0,097	VBMT 1103	32 €
D232	SVJBR 1212 J11	110	21	12	16	12	0,141	ISO.	32 €
D234	SVJBR 1616 H11	100	25	16	20	16	0,192		35 €
D235	SVJBR 1616 H16	100	33	16	20	16	0,192	VBMT 1604	35 €
D236	SVJBR 2020 K16	125	33	20	25	20	0,382	ISO.	36 €
D238	SVJBR 2525 M16	150	40	25	32	25	0,688		37 €
D238-1	SVJBR 3232 P16	170	40	32	40	32	1,370		44 €

Code						
D230-D234	TC061 M2,5x5,5	---	---	---	T8	
D235-D238-1	TC068 M3,5x11	TA034	---	TC048 M5	T15	

### 93° SVJBL

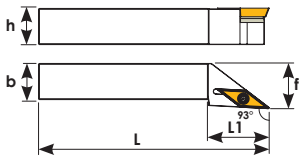
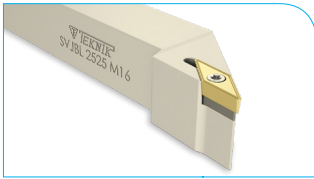

Order Code	Product Code	Dimensions (mm)						Insert	Price
		L	L1	h	f	b			
D370	SVJBL 1010 J11	110	21	10	12	10	0,097	VBMT 1103	32 €
D372	SVJBL 1212 J11	110	21	12	16	12	0,141	ISO.	32 €
D373	SVJBL 1616 H11	100	25	16	20	16	0,192		35 €
D374	SVJBL 1616 H16	100	33	16	20	16	0,192	VBMT 1604	35 €
D380	SVJBL 2020 K16	125	33	20	25	20	0,382	ISO.	36 €
D382	SVJBL 2525 M16	150	40	25	32	25	0,688		37 €
D382-1	SVJBL 3232 P16	170	40	32	40	32	1,370		44 €
<b>Code</b>									
D370-D373		TC061 M2,5x6,5	---	---	T8				
D374-D238-1		TC068 M3,5x11	TA034	TC048 M5	T15				

### 72,5° SVVBN

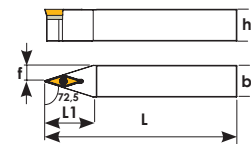

Order Code	Product Code	Dimensions (mm)						Insert	Price
		L	L1	h	f	b			
D131	SVVBN 1212 J11	110	25	12	6	12	0,129	VBMT 1103 ISO	32 €
D132	SVVBN 1616 H16	100	33	16	8	16	0,184	VBMT 1604	35 €
D138	SVVBN 2020 K16	125	35	20	10	20	0,370	ISO.	35 €
D140	SVVBN 2525 M16	150	40	25	12,5	25	0,668		37 €
D141	SVVBN 3232-P16	170	40	32	40	32	1,386		44 €
<b>Code</b>									
D131		TC061 M2,5x6,5	---	---	T8				
D132-D141		TC068 M3,5x11	TA034	TC048 M5	T15				

### 107,5° SVHBR

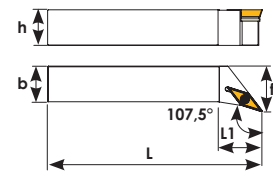
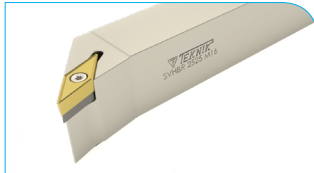

Order Code	Product Code	Dimensions (mm)						Insert	Price
		L	L1	h	f	b			
D354-1	SVHBR 2020 K16	125	30	20	25	20	0,387	VBMT 1604	36 €
D356-1	SVHBR 2525 M16	150	30	25	32	25	0,712	ISO.	37 €
<b>Code</b>									
D354-1		TC068 M3,5x11	TA034	TC048 M5	T15				

### 107,5° SVHBL

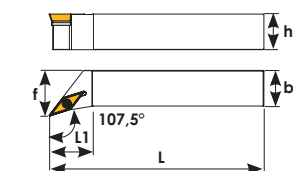
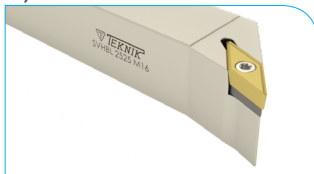

Order Code	Product Code	Dimensions (mm)						Insert	Price
		L	L1	h	f	b			
D355	SVHBL 2020 K16	125	30	20	25	20	0,387	VBMT 1604	36 €
D356-2	SVHBL 2525 M16	150	30	25	32	25	0,712	ISO.	37 €
<b>Code</b>									
D355		TC068 M3,5x11	TA034	TC048 M5	T15				

### 93° SVJBR-F

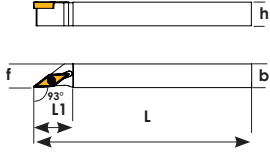
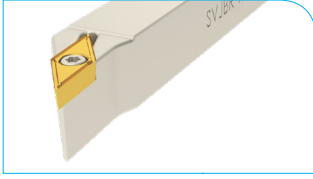

Order Code	Product Code	Dimensions (mm)						Insert	Price
		L	L1	h	f	b			
D128	SVJBR 1010 J11-F	110	22	10	10	10	0,098		32 €
D129	SVJBR 1212 J11-F	110	22	12	12	12	0,132	VBMT 1103	32 €
D130	SVJBR 1616 H11-F	100	25	16	16	16	0,204	ISO.	35 €
<b>Code</b>									
		TC061 M2,5x6,5		TA034		TC048 M5		T8	

### 93° SVJBL-F

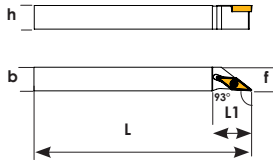
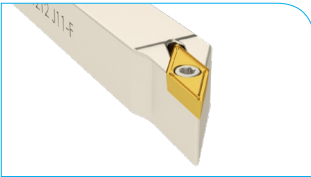

Order Code	Product Code	Dimensions (mm)						Insert	Price
		L	L1	h	f	b			
D395	SVJBL 1010 J11-F	110	22	10	10	10	0,098		32 €
D396	SVJBL 1212 J11-F	110	22	12	12	12	0,132	VBMT 1103	32 €
D397	SVJBL 1616 H11-F	100	25	16	16	16	0,204	ISO.	35 €
<b>Code</b>									
		TC061 M2,5x6,5		TA034		TC048 M5		T8	

### 93° SVJCR

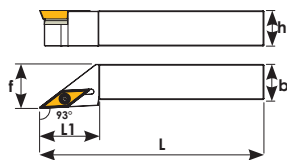

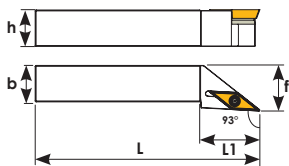
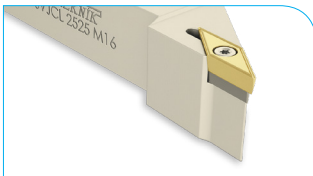

Order Code	Product Code	Dimensions (mm)						Insert	Price
		L	L1	h	f	b			
D239	SVJCR 1010 J11	110	21	10	12	10	0,086		32 €
D240	SVJCR 1212 J11	110	21	12	16	12	0,135	VCMT 1103	32 €
D241	SVJCR 1616 H11	100	25	16	20	16	0,204	ISO.	35 €
D242	SVJCR 2020 K11	125	33	20	25	20	0,378		36 €
D243	SVJCR 2525 M11	150	40	25	32	25	0,738		37 €
D244	SVJCR 1616 H16	100	33	16	20	16	0,195	VCMT 1604	35 €
D246	SVJCR 2020 K16	125	33	20	25	20	0,385	ISO.	36 €
D248	SVJCR 2525 M16	150	40	25	32	25	0,683		37 €
D249	SVJCR 3232 P16	170	50	32	40	32	1,284		44 €
<b>Code</b>									
D239-D243		TC061 M2,5x6,5		---	---	T8			
D244-D249		TC068 M3,5x11		TA034	TC048 M5	T15			

### 93° SVJCL



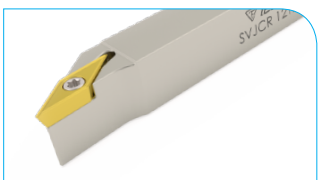
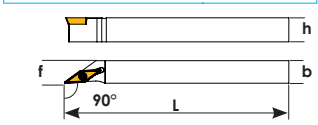

Order Code	Product Code	Dimensions (mm)						Insert	Price
		L	L1	h	f	b			
D383	SVJCL 1010 J11	110	21	10	12	10	0,086		32 €
D384	SVJCL 1212 J11	110	21	12	16	12	0,135	VCMT 1103	32 €
D385	SVJCL 1616 H11	100	25	16	20	16	0,204	ISO.	35 €
D386	SVJCL 2020 K11	125	33	20	25	20	0,378		36 €
D387	SVJCL 2525 M11	150	40	25	32	25	0,738		37 €
D388	SVJCL 1616 H16	100	33	16	20	16	0,195	VCMT 1604	35 €
D390	SVJCL 2020 K16	125	33	20	25	20	0,385	ISO.	36 €
D392	SVJCL 2525 M16	150	40	25	32	25	0,683		37 €
D393	SVJCL 3232 P16	170	50	32	40	32	1,284		44 €
<b>Code</b>									
D383-D387		TC061 M2,5x7		---	---	T8			
D388-D923		TC068 M3,5x11		TA034	TC048 M5	T15			

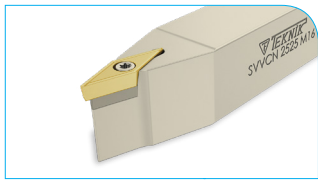
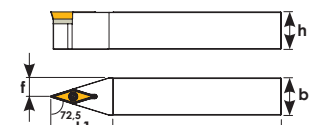
90° SVJCR -F	Order Code	Product Code	Dimensions (mm)					Insert	Price
			L	h	f	b			
	D460	SVJCR 1212 J11-F	110	12	12	12	0,134	VCMT 1103	32 €
	D462	SVJCR 1616 H11-F	100	16	16	16	0,202	ISO.	35 €

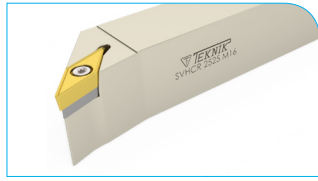
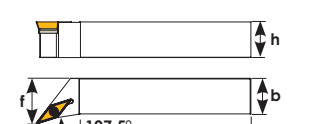
72,5° SVVCN	Order Code	Product Code	Dimensions (mm)						Insert	Price
			L	L1	h	f	b			
	D142	SVVCN 1212 J11	110	22	12	6	12	0,127	VCMT 1103 ISO	32 €
	D144	SVVCN 1616 H16	100	35	16	8	16	0,187	VCMT 1604	35 €
	D150	SVVCN 2020 K16	125	35	20	10	20	0,373	ISO.	36 €
	D152	SVVCN 2525 M16	150	40	25	12.5	25	0,675		37 €

107,5° SVHCR	Order Code	Product Code	Dimensions (mm)					Insert	Price	
			L	L1	h	f	b			
	D254	SVHCR 2020 K16	125	30	20	25	20	0,384	VCMT 1604	36 €
	D256	SVHCR 2525 M16	150	30	25	32	25	0,707	ISO.	37 €

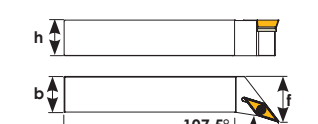
SVHCL	Order Code	Product Code	Dimensions (mm)					Insert	Price	
			L	L1	h	f	b			
	D354	SVHCL 2020 K16	125	30	20	25	20	0,384	VCMT 1604	36 €
	D356	SVHCL 2525 M16	150	30	25	32	25	0,707	ISO.	37 €

### 30° SRGCR

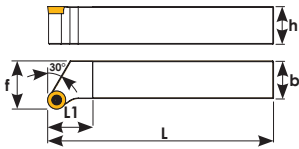
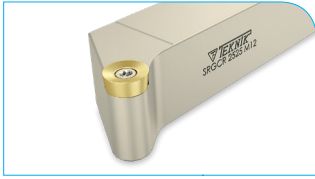

Order Code	Product Code	Dimensions (mm)						Insert	Price
		L	L1	h	f	b			
D280	SRGCR 2020 K08	125	25	20	25	20	0,411	RCMT 0803	36 €
D282	SRGCR 2525 M08	150	30	25	32	25	0,710	ISO.	37 €
D284	SRGCR 2020 K10	125	25	20	25	20	0,410	RCMT 10T3	36 €
D286	SRGCR 2525 M10	150	30	25	32	25	0,720	ISO.	37 €
D288	SRGCR 2020 K12	125	25	20	25	20	0,422	RCMT 1204	36 €
D290	SRGCR 2525 M12	150	30	25	32	25	0,744	ISO.	37 €

Code				
D280-D282	TC065 M3x7	T8		
D284-D290	TC067 M3,5x8,5	T15		

### 30° SRGCL

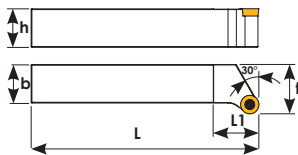
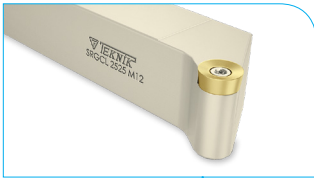

Order Code	Product Code	Dimensions (mm)						Insert	Price
		L	L1	h	f	b			
D293	SRGCL 2020 K08	125	25	20	25	20	0,411	RCMT 0803	36 €
D294	SRGCL 2525 M08	150	30	25	32	25	0,710	ISO.	37 €
D283	SRGCL 2020 K10	125	25	20	25	20	0,410	RCMT 10T3	36 €
D292	SRGCL 2525 M10	150	30	25	32	25	0,720	ISO.	37 €
D281	SRGCL 2020 K12	125	25	20	25	20	0,422	RCMT 1204 ISO.	36 €
D291	SRGCL 2525 M12	150	30	25	32	25	0,744	ISO.	37 €

Code				
D293-D294	TC065 M3x7	T8		
D283-D291	TC067 M3,5x8,5	T15		

### SRDCN

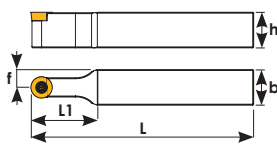
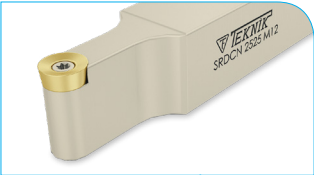

Order Code	Product Code	Dimensions (mm)						Insert	Price
		L	L1	h	f	b			
D270	SRDCN 2020 K08	125	37	20	10	20	0,358	RCMT 0803	36 €
D271	SRDCN 2525 M08	150	37	25	12.5	25	0,653	ISO.	37 €
D272	SRDCN 2020 K10	125	35	20	10	20	0,370	RCMT 10T3	36 €
D274	SRDCN 2525 M10	150	35	25	12.5	25	0,670	ISO.	37 €
D276	SRDCN 2020 K12	125	33	20	10	20	0,372	RCMT 1204	36 €
D278	SRDCN 2525 M12	150	38	25	12.5	25	0,668	ISO.	37 €
D273	SRDCN 2525 M16	150	35	25	12.5	25	0,701	RCMT 1605 ISO.	37 €

Code				
D270-D271	TC065 M3x7	T8		
D272-D278	TC067 M3,5x8,5	T15		
D273	TC083 M5x12			

### TIRTIL Kater

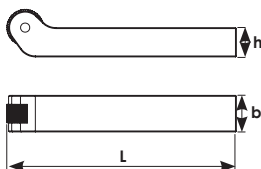

Order Code	Product Code			Dimensions (mm)			Price	
				L	h	b		
P100	16-20 CNC TIRTIL	20x10x6	BSP041 6-23	125	16	20	0,351	42 €
P102	20-20 CNC TIRTIL	20x10x6	BSP041 6-18	125	20	20	0,427	42 €
P104	25-25 CNC TIRTIL	20x10x6	BSP040 6-23	150	25	25	0,600	47 €



## P System Boring Bars



[www.teknikcuttingtools.com](http://www.teknikcuttingtools.com)



Kalite için TEKNİK çözüm  
Technical solution for quality

98-101



93° PDUNR IC  
With Coolant

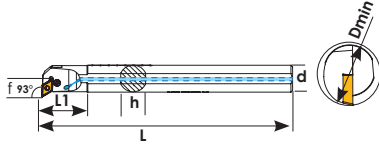

Order Code	Product Code	Dimensions (mm)							Insert	Price
		Dmin	d	L	L1	f	h			
AP300	A25S PDUNR 15	32	25	250	50	17	23	0,900		63 €
AP302	A32T PDUNR 15	40	32	300	55	22	30	1,770	DNMG 1506	76 €
AP304	A40T PDUNR 15	50	40	300	55	27	38	1,790	ISO.	94 €

Code						
AP300	TH6134	---	---	TL4A	2,5 Allen	
AP302 - AP304	TH822	TA014-1	TS-4	TL4B	3 Allen	

93° PDUNR

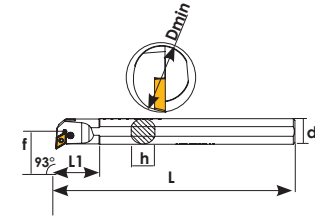
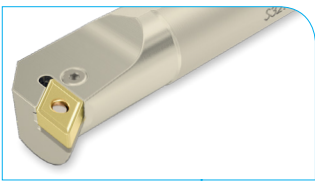

Order Code	Product Code	Dimensions (mm)							Insert	Price
		Dmin	d	L	L1	f	h			
P300	S25S PDUNR 15	32	25	250	50	17	23	0,930		58 €
P302	S32T PDUNR 15	40	32	300	55	22	30	1,805	DNMG 1506	70 €
P304	S40T PDUNR 15	50	40	300	55	27	38	2,790	ISO.	87 €

Code						
P300	TH6134	---	---	TL4A	TL4A	
P302 - P304	TH822	TA014-1	TS-4	TL4B	3 Allen	

93° PDUNL IC  
With Coolant

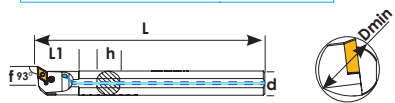
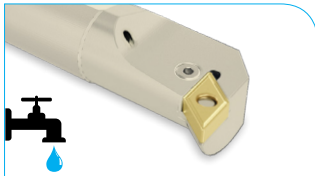

Order Code	Product Code	Dimensions (mm)							Insert	Price
		Dmin	d	L	L1	f	h			
AP310	A25S PDUNL 15	32	25	250	50	17	23	0,900		63 €
AP312	A32T PDUNL 15	40	32	300	55	22	30	1,770	DNMG 1506	76 €
AP314	A40T PDUNL 15	50	40	300	55	27	38	1,790	ISO.	94 €

Code						
AP310	TH6134	---	---	TL4A	2,5 Allen	
AP312 - AP314	TH822	TA014-1	TS-4	TL4B	3 Allen	

93° PDUNL

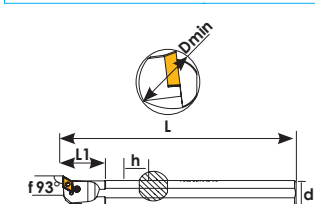

Order Code	Product Code	Dimensions (mm)							Insert	Price
		Dmin	d	L	L1	f	h			
P310	S25S PDUNL 15	32	25	250	50	17	23	0,930		58 €
P312	S32T PDUNL 15	40	32	300	55	22	30	1,805	DNMG 1506	70 €
P314	S40T PDUNL 15	50	40	300	55	27	38	2,790	ISO.	87 €

Code						
P310	TH6134	---	---	TL4A	TL4A	
P312 - P314	TH822	TA014-1	TS-4	TL4B	3 Allen	

95° PCLNR IC  
With Coolant

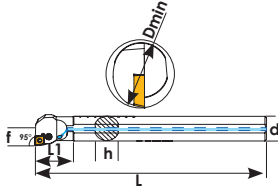

Order Code	Product Code	Dimensions (mm)							Insert	Price
		Dmin	d	L	L1	f	h			
AP337	A20R PCLNL 09	25	20	200	40	13	18	0,435	CNMG 09T3	58 €
AP338	A20R PCLNR 12	24	20	200	50	13	18	0,520		58 €
AP340	A25S PCLNR 12	32	25	250	50	17	23	0,921	CNMG 1204	63 €
AP342	A32T PCLNR 12	40	32	300	50	22	30	1,809	ISO.	76 €
AP344	A40T PCLNR 12	50	40	300	55	27	38	1,820		94 €
<p><b>Code</b> </p> <p>AP337 THB617 TA023 TS3 TL3 2,5 Allen</p> <p>AP338-AP340 TH6134 --- --- TL4A 2,5 Allen </p> <p>AP342 - AP344 TH821 TA016-1 TS-4 TL4 3 Allen</p>										

95° PCLNR

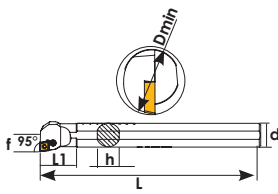
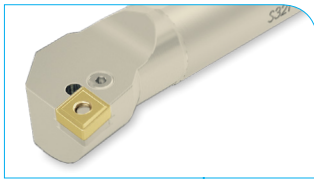

Order Code	Product Code	Dimensions (mm)							Insert	Price
		Dmin	d	L	L1	f	h			
P338	S20R PCLNR 12	24	20	200	50	13	18	0,540		55 €
P340	S25S PCLNR 12	32	25	250	50	17	23	0,978	CNMG 1204	58 €
P342	S32T PCLNR 12	40	32	300	50	22	30	1,815	ISO.	70 €
P344	S40T PCLNR 12	50	40	300	55	27	38	1,825		87 €
<p><b>Code</b> </p> <p>P338 - P340 TH6134 --- --- TL4A 2,5 Allen</p> <p>P342 - P344 TH821 TA016-1 TS-4 TL4 3 Allen </p>										

95° PCLNL IC  
With Coolant

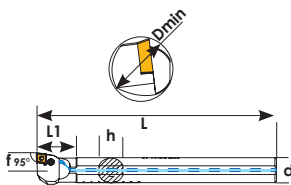
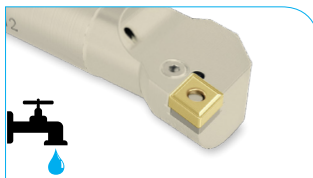

Order Code	Product Code	Dimensions (mm)							Insert	Price
		Dmin	d	L	L1	f	h			
AP347	A20R PCLNR 09	26	20	200	40	13	18	0,435	CNMG 09T3	58 €
AP348	A20R PCLNL 12	24	20	200	50	13	18	0,520		58 €
AP350	A25S PCLNL 12	32	25	250	50	17	23	0,921	CNMG 1204	63 €
AP352	A32T PCLNL 12	40	32	300	50	22	30	1,809	ISO.	76 €
AP354	A40T PCLNL 12	50	40	300	55	27	38	1,820		94 €
<p><b>Code</b> </p> <p>AP347 TH617 TA023 TS3 TL3 2,5 Allen</p> <p>AP348-AP350 TH6134 --- --- TL4A 2,5 Allen</p> <p>AP352 - AP354 TH821 TA016-1 TS-4 TL4 3 Allen </p>										

95° PCLNL

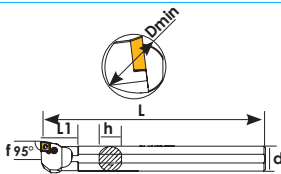
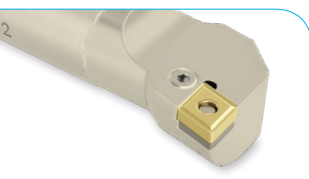

Order Code	Product Code	Dimensions (mm)							Insert	Price
		Dmin	d	L	L1	f	h			
P348	20R PCLNL 12	24	20	200	50	13	18	0,540		55 €
P350	S25S PCLNL 12	32	25	250	50	17	23	0,978	CNMG 1204	58 €
P352	S32T PCLNL 12	40	32	300	50	22	30	1,815	ISO.	70 €
P354	S40T PCLNL 12	50	40	300	55	27	38	1,825		87 €
<p><b>Code</b> </p> <p>P348 - P350 TH6134 --- --- TL4A 2,5 Allen</p> <p>P352 - P354 TH821 TA016-1 TS-4 TL4 3 Allen </p>										

95° PWLNR 08 IC  
With Coolant

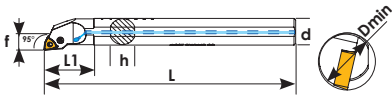
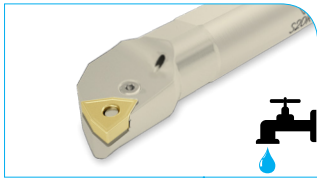

Order Code	Product Code	Dimensions (mm)							Insert	Price
		Dmin	d	L	L1	f	h			
AP360	A25S PWLNR 08	32	25	250	50	17	23	0,911		63 €
AP362	A32T PWLNR 08	40	32	300	60	22	30	1,764	WNMG 0804	76 €
AP364	A40T PWLNR 08	50	40	300	60	27	38	2,800	ISO.	94 €
<b>Code</b>										
AP360	TH6134	---	---	TL4A	2,5 Allen					
AP362 - P364	TH821	TA020-1	TS-4	TL4	3 Allen					

95° PWLNR 08

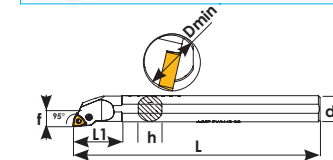
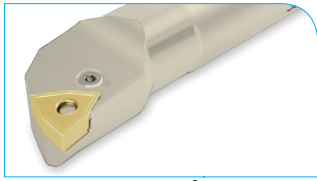

Order Code	Product Code	Dimensions (mm)							Insert	Price
		Dmin	d	L	L1	f	h			
P360	S25S PWLNR 08	32	25	250	50	17	23	0,911		58 €
P362	S32T PWLNR 08	40	32	300	60	22	30	1,764	WNMG 0804	70 €
P364	S40T PWLNR 08	50	40	300	60	27	38	2,450	ISO.	87 €
<b>Code</b>										
P360	TH6134	---	---	TL4A	2,5 Allen					
P362 - P364	TH821	TA020-1	TS-4	TL4	3 Allen					

95° PWLNL 08 IC  
With Coolant

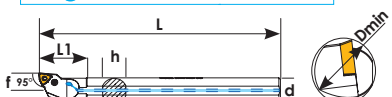
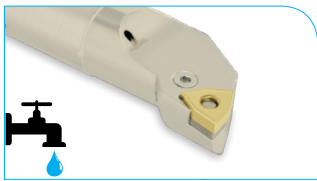

Order Code	Product Code	Dimensions (mm)							Insert	Price
		Dmin	d	L	L1	f	h			
AP370	A25S PWLNL 08	32	25	250	50	17	23	0,911		63 €
AP372	A32T PWLNL 08	40	32	300	60	22	30	1,764	WNMG 0804	76 €
AP374	A40T PWLNL 08	50	40	300	60	27	38	2,800	ISO.	94 €
<b>Code</b>										
AP370	TH6134	---	---	TL4A	2,5 Allen					
AP372 - P374	TH821	TA020-1	TS-4	TL4	3 Allen					

95° PWLNL 08

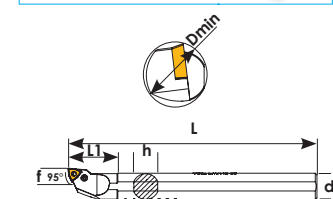
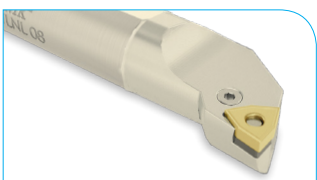

Order Code	Product Code	Dimensions (mm)							Insert	Price
		Dmin	d	L	L1	f	h			
P370	S25S PWLNL 08	32	25	250	50	17	23	0,911		58 €
P372	S32T PWLNL 08	40	32	300	60	22	30	1,764	WNMG 0804	70 €
P374	S40T PWLNL 08	50	40	300	60	27	38	2,450	ISO.	87 €
<b>Code</b>										
P370	TH6134	---	---	TL4A	2,5 Allen					
P372 - P374	TH821	TA020-1	TS-4	TL4	3 Allen					

**95° PWLNR 06 IC**  
With Coolant

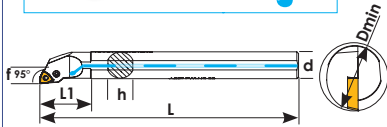
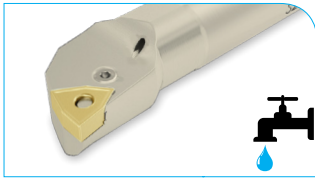

Order Code	Product Code	Dimensions (mm)							Insert	Price
		Dmin	d	L	L1	f	h			
AP380	A16R PWLNR 06	20	16	200	40	11	15	0,326	WNMG 0604	59 €
AP382	A20R PWLNR 06	25	20	200	40	13	18	0,471	ISO.	59 €

TH512 M5	TL3B	2 Allen	

**95° PWLNR 06**

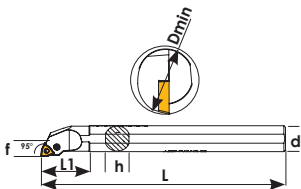
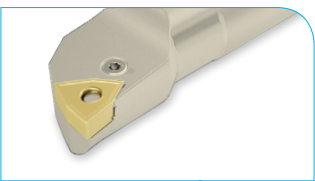

Order Code	Product Code	Dimensions (mm)							Insert	Price
		Dmin	d	L	L1	f	h			
P380	S16R PWLNR 06	20	16	200	40	11	15	0,316	WNMG 0604	55 €
P382	S20R PWLNR 06	25	20	200	40	13	18	0,502	ISO.	55 €

TH512 M5	TL3B	2 Allen	

**95° PWLNL 06 IC**  
With Coolant

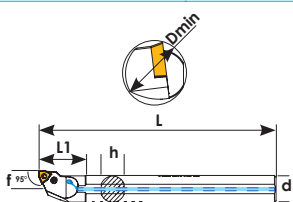
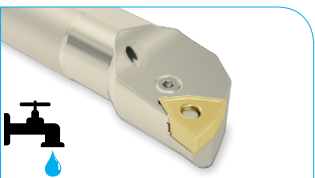

Order Code	Product Code	Dimensions (mm)							Insert	Price
		Dmin	d	L	L1	f	h			
AP388	A16R PWLNL 06	20	16	200	40	11	15	0,326	WNMG 0604	59 €
AP390	A20R PWLNL 06	25	20	200	40	13	18	0,471	ISO.	59 €

TH512 M5	TL3B	2 Allen	

**95° PWLNL 06**

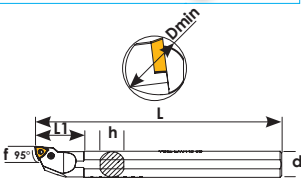
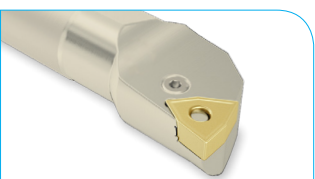

Order Code	Product Code	Dimensions (mm)							Insert	Price
		Dmin	d	L	L1	f	h			
P388	S16R PWLNL 06	20	16	200	40	11	15	0,316	WNMG 0604	55 €
P390	S20R PWLNL 06	25	20	200	40	13	18	0,502	ISO.	55 €

TH512 M5	TL3B	2 Allen	

**Kalite için TEKNİK çözüm**  
Technical solution for quality



## D-M System Boring Bars



[www.teknikcuttingtools.com](http://www.teknikcuttingtools.com)



Kalite için TEKNİK çözüm  
Technical solution for quality

104-107



93° DDUNR

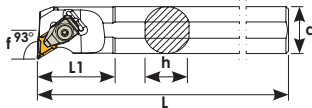
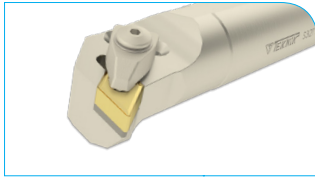

Order Code	Product Code	Dimensions (mm)							Insert	Price
		Dmin	d	L	L1	f	h	kg		
K408	S20R DDUNR 11	30	20	200	50	13	18	0,508	DNMG 1104	55 €
K409	S25S DDUNR 11	32	25	250	50	17	23	0,956	ISO.	58 €
K410	S25S DDUNR 15	32	25	250	50	17	23	0,950		58 €
K412	S32T DDUNR 15	40	32	300	55	22	30	1,835		70 €
K414	S40T DDUNR 15	50	40	300	60	27	38	2,848		87 €
K415	S40U DDUNR 15	50	40	350	60	27	38	3,336	DNMG 1506	105 €
K416	S50U DDUNR 15	63	50	350	65	35	47	5,153	ISO.	105 €
K417	S50X DDUNR 15	63	50	550	65	35	47	8,716		124 €
K417-1	S60X DDUNR 15	73	60	600	65	37,5	57	13,66		143 €
K411	S25S DDUNR 15	32	25	250	50	17	23	0,958	DNMG 1504	58 €
K413	S32T DDUNR 15	40	32	300	55	22	30	1,830	ISO.	70 €

Code								
K408 - K409	TC046 M5	TA013	TC034 M3x7	BK024	BY041	BSP031	3 Allen	
K410 - K413	TC044 M6	TA014-1	TC038 M4x10	BK020	BY040	BSP030	3 Allen	

93° DDUNL

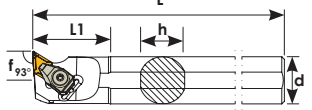
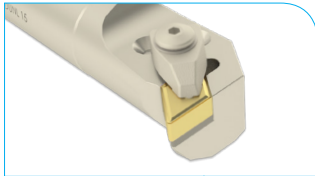

Order Code	Product Code	Dimensions (mm)							Insert	Price
		Dmin	d	L	L1	f	h	kg		
K487	S20R DDUNL 11	30	20	200	50	13	18	0,508	DNMG 1104	55 €
K488	S25S DDUNL 11	32	25	250	50	17	23	0,956	ISO.	58 €
K490	S25S DDUNL 15	32	25	250	50	17	23	0,950		58 €
K492	S32T DDUNL 15	40	32	300	55	22	30	1,835	DNMG 1506	70 €
K494	S40T DDUNL 15	50	40	300	60	27	38	2,848	ISO.	87 €
K495	S40U DDUNL 15	50	40	350	60	27	38	3,336		105 €
K496	S50U DDUNL 15	63	50	350	65	35	47	5,153		105 €

Code								
K487 - K488	TC046 M5	TA013	TC034 M3x7	BK024	BY041	BSP031	3 Allen	
K490 - K496	TC044 M6	TA014-1	TC038 M4x10	BK020	BY040	BSP030	3 Allen	

107,5° DDQNR

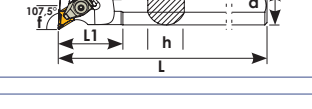
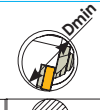
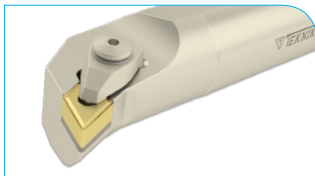

Order Code	Product Code	Dimensions (mm)							Insert	Price
		Dmin	d	L	L1	f	h	kg		
K476	S25S DDQNR 15	32	25	250	50	17	23	0,935		58 €
K477	S32T DDQNR 15	40	32	300	60	22	30	1,805	DNMG 1506	70 €
K478	S40T DDQNR 15	50	40	300	60	27	38	2,786	ISO.	87 €
K479	S50U DDQNR 15	63	50	350	65	35	47	5,166		105 €

Code								
	TC044 M6	TA014-1	TC038 M4x10	BK020	BY040	BSP030	3 Allen	

107,5° DDQNL

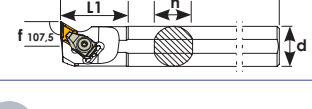
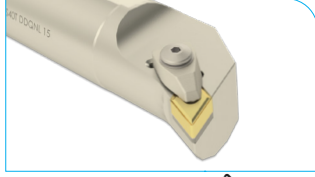

Order Code	Product Code	Dimensions (mm)							Insert	Price
		Dmin	d	L	L1	f	h	kg		
K533	S25S DDQNL 15	32	25	250	50	17	23	0,935		58 €
K534	S32T DDQNL 15	40	32	300	60	22	30	1,805	DNMG 1506	70 €
K535	S40T DDQNL 15	50	40	300	60	27	38	2,786	ISO.	87 €
K536	S50U DDQNL 15	63	50	350	65	35	47	5,166		105 €

Code								
	TC044 M6	TA014-1	TC038 M4x10	BK020	BY040	BSP030	3 Allen	



93° MDUNR

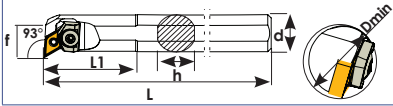
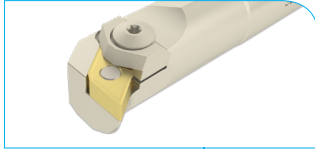

Order Code	Product Code	Dimensions (mm)							Insert	Price
		Dmin	d	L	L1	f	h	kg		
K408-1	S20R MDUNR 11	25	20	200	50	13	18	0,508	DNMG 1104 ISO.	55 €

62,5° DDWNR

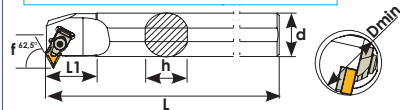
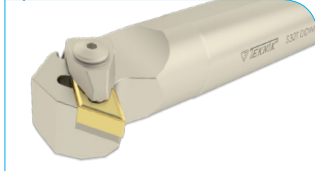

Order Code	Product Code	Dimensions (mm)							Insert	Price
		Dmin	d	L	L1	f	h	kg		
K464	S32T DDWNR 15	40	32	300	55	24	30	1,859		70 €
K466	S40T DDWNR 15	50	40	300	50	30	38	2,918	DNMG 1506	87 €
K468	S50U DDWNR 15	63	50	350	60	35	47	5,298	ISO.	105 €

60° MTENR

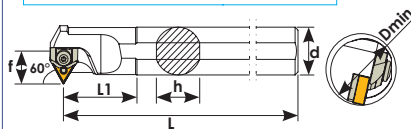
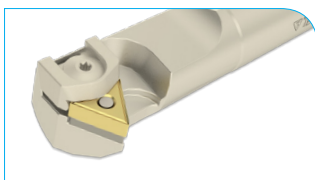

Order Code	Product Code	Dimensions (mm)							Insert	Price
		Dmin	d	L	L1	f	h	kg		
K456	S25S MTENR 16	32	25	250	55	17	23	0,960		58 €
K458	S32T MTENR 16	40	32	300	60	22	30	1,842	TNMG 1604	70 €
K460	S40T MTENR 16	50	40	300	60	27	38	2,802	ISO.	87 €
K462	S50U MTENR 16	63	50	350	70	35	47	5,125		105 €

93° MTUNR

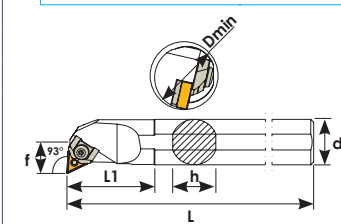
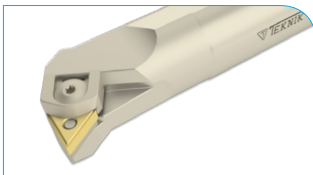

Order Code	Product Code	Dimensions (mm)							Insert	Price
		Dmin	d	L	L1	f	h	kg		
K441	S20R MTUNR 16	25	20	200	50	13	18	0,513		55 €
K442	S25S MTUNR 16	32	25	250	50	17	23	0,952	TNMG 1604	58 €
K444	S32T MTUNR 16	40	32	300	60	22	30	1,835	ISO.	70 €
K446	S40T MTUNR 16	50	40	300	60	27	38	2,852		87 €
K448	S50U MTUNR 16	63	50	350	65	35	47	5,150		105 €
K450	S32T MTUNR 22	40	32	300	60	22	30	1,836	TNMG 2204	70 €
K452	S40T MTUNR 22	50	40	300	60	27	38	2,814	ISO.	87 €
K454	S50U MTUNR 22	63	50	350	65	35	47	5,145		105 €
<p><b>Code</b></p>										

93° MTUNL

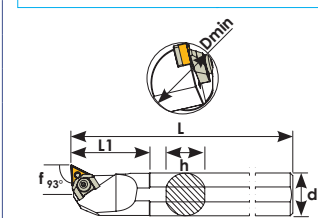
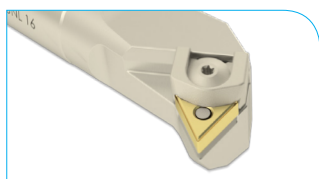

Order Code	Product Code	Dimensions (mm)							Insert	Price
		Dmin	d	L	L1	f	h	kg		
K519	S20R MTUNL 16	25	20	200	30	13	18	0,513		55 €
K520	S25S MTUNL 16	32	25	250	50	17	23	0,952	TNMG 1604	58 €
K522	S32T MTUNL 16	40	32	300	60	22	30	1,835	ISO.	70 €
K524	S40T MTUNL 16	50	40	300	60	27	38	2,852		87 €
K526	S50U MTUNL 16	63	50	350	65	35	47	5,150		105 €
K528	S32T MTUNL 22	40	32	300	60	22	30	1,836	TNMG 2204	70 €
K530	S40T MTUNL 22	50	40	300	60	27	38	2,814	ISO.	87 €
K532	S50U MTUNL 22	63	50	350	65	35	47	5,145		105 €
<p><b>Code</b></p>										

### 107,5° MTQNR

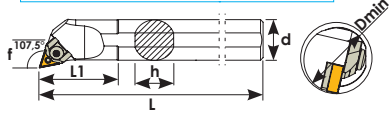

Order Code	Product Code	Dimensions (mm)							Insert	Price
		Dmin	d	L	L1	f	h			
K365	S25S MTQNR 16	32	25	250	50	17	23	0,942		58 €
K366	S32T MTQNR 16	40	32	300	60	22	30	1,821	TNMG 1604	70 €
K367	S40T MTQNR 16	50	40	300	60	27	38	2,807	ISO.	87 €
K368	S50U MTQNR 16	63	50	350	65	35	47	5,121		105 €

### 107,5° MTQNL

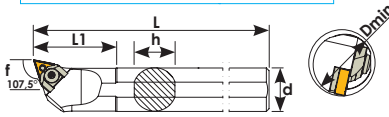

Order Code	Product Code	Dimensions (mm)							Insert	Price
		Dmin	d	L	L1	f	h			
K537	S25S MTQNL 16	32	25	250	50	17	23	0,942		58 €
K538	S32T MTQNL 16	32	25	250	50	17	23	1,821	TNMG 1604	70 €
K539	S40T MTQNL 16	40	32	300	60	22	30	2,807	ISO.	87 €
K540	S50U MTQNL 16	50	40	300	60	27	38	5,121		105 €

### 95° MWLNR

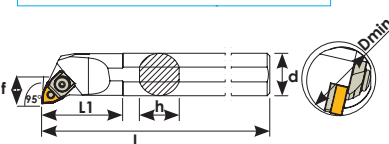
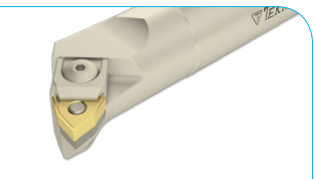

Order Code	Product Code	Dimensions (mm)							Insert	Price
		Dmin	d	L	L1	f	h			
K427	S16Q MWLNR 06	21	16	180	40	11	15	0,286	WNMG 0604	55 €
K427-1	S20R MWLNR 06	25	20	200	50	13	18	0,502	ISO.	55 €
K428	S25S MWLNR 08	32	25	250	45	17	23	0,945		58 €
K430	S32T MWLNR 08	40	32	300	60	22	30	1,833	WNMG 0804	70 €
K432	S40T MWLNR 08	50	40	300	60	27	38	2,841	ISO.	87 €
K434	S50U MWLNR 08	63	50	350	65	35	47	5,110		105 €

### 95° MWLNL

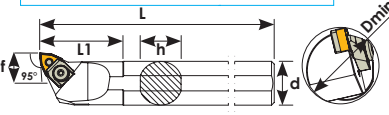
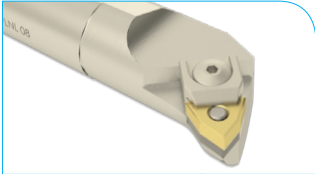

Order Code	Product Code	Dimensions (mm)							Insert	Price
		Dmin	d	L	L1	f	h			
K510	S25S MWLNL 08	32	25	250	45	17	23	0,945		58 €
K512	S32T MWLNL 08	40	32	300	60	22	30	1,833	WNMG 0804	70 €
K514	S40T MWLNL 08	50	40	300	60	27	38	2,841	ISO.	87 €
K516	S50U MWLNL 08	63	50	350	65	35	47	5,110		105 €

### 95° DWLNR

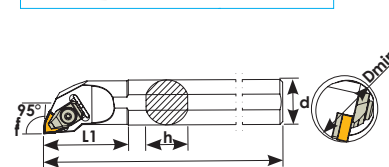
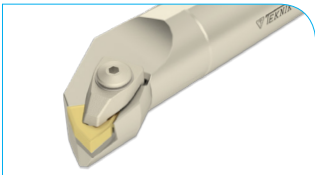

Order Code	Product Code	Dimensions (mm)							Insert	Price
		Dmin	d	L	L1	f	h			
K418	S25S DWLNR 06	32	25	250	50	17	23	0,955	WNMG 0604 ISO	58 €
K420	S25S DWLNR 08	32	25	250	50	17	23	0,966		58 €
K422	S32T DWLNR 08	40	32	300	60	22	30	1,837	WNMG 0804	70 €
K424	S40T DWLNR 08	50	40	300	60	27	38	2,820	ISO.	87 €
K426	S50U DWLNR 08	63	50	350	75	35	47	5,123		105 €

### 95° DWLNL

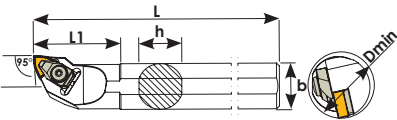
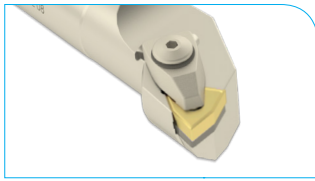

Order Code	Product Code	Dimensions (mm)							Insert	Price
		Dmin	d	L	L1	f	h			
K498	S25S DWLNL 06	32	25	250	50	17	23	0,955	WNMG 0604 ISO	58 €
K500	S25S DWLNL 08	32	25	250	50	17	23	0,966	WNMG 0804	58 €
K502	S32T DWLNL 08	40	32	300	60	22	30	1,837	ISO.	70 €
K504	S40T DWLNL 08	50	40	300	60	27	38	2,820		87 €
K506	S50U DWLNL 08	63	50	350	75	35	47	5,123		105 €

Code								
K498	TC046 M5	TA021	TC034 M3x7	BK024	BY041	BSP031	3 Allen	
K500 - K506	TC044 M6	TA020-1	TC038 M4x10	BK020	BY040	BSP030	3 Allen	

### 95° DCLNR

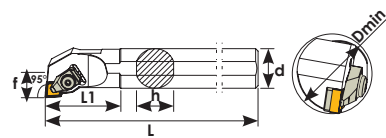
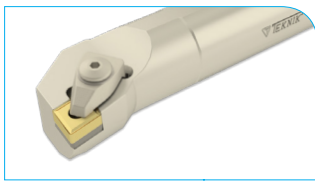

Order Code	Product Code	Dimensions (mm)							Insert	Price
		Dmin	d	L	L1	f	h			
K400	S25S DCLNR 12	32	25	250	50	17	23	0,964		58 €
K402	S32T DCLNR 12	40	32	300	60	22	30	1,867	CNMG 1204	70 €
K404	S40T DCLNR 12	50	40	300	60	27	38	2,845	ISO.	87 €
K406	S50U DCLNR 12	63	50	350	60	35	47	5,166		105 €
K370	S32U DCLNR 16	40	32	350	60	22	30	2,272	CNMG 1606	81 €
K371	S40U DCLNR 16	50	40	350	60	27	38	3,550	ISO.	97 €
K374	S40U DCLNR 19	50	40	350	60	27	38	3,503	CNMG 1906	108 €
K375	S50V DCLNR 19	63	50	400	60	35	47	6,333	ISO.	129 €

Code								
K400-K406	TC044 M6	TA016-1	TC038 M4x10	BK020	BY040	BSP030	3 Allen	
K370-K371	TC044 M6	TA022	TC095 M5x11,8	BK018			3 Allen	
K374-K375	TC048 M8	TA017	TC039 M6x12	BK025	BY044	BSP032		

### 95° DCLNL

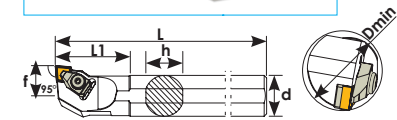
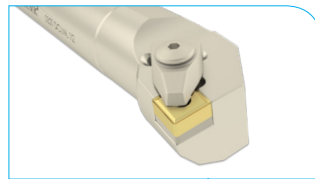

Order Code	Product Code	Dimensions (mm)							Insert	Price
		Dmin	d	L	L1	f	h			
K480	S25S DCLNL 12	32	25	250	50	17	23	0,964		58 €
K482	S32T DCLNL 12	40	32	300	60	22	30	1,867	CNMG 1204	70 €
K484	S40T DCLNL 12	50	40	300	60	27	38	2,845	ISO.	87 €
K486	S50U DCLNL 12	63	60	350	75	35	47	5,166		105 €

Code								
	TC044 M6	TA016-1	TC038 M4x10	BK020	BY040	BSP030	3 Allen	

### 75° DCKNR

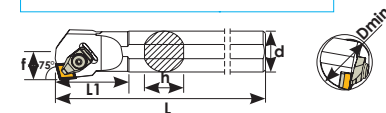
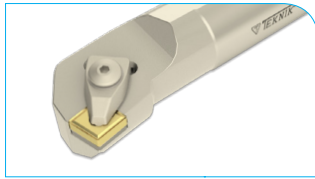

Order Code	Product Code	Dimensions (mm)							Insert	Price
		Dmin	d	L	L1	f	h			
K401	S25S DCKNR 12	32	25	250	55	17	23	0,955		58 €
K403	S32T DCKNR 12	40	32	300	60	22	30	0,966	CNMG 1204	70 €
K405	S40T DCKNR 12	50	40	300	65	27	38	1,837	ISO.	87 €

Code								
	TC044 M6	TA016-1	TC038 M4x10	BK020	BY040	BSP030	3 Allen	

### 93° CKUNR

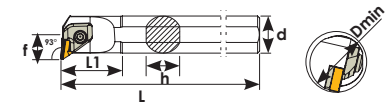

Order Code	Product Code	Dimensions (mm)							Insert	Price
		Dmin	d	L	L1	f	h			
K750	S25T CKUNR 16	32	25	300	52	19	23	1,400		58 €
K754	S32U CKUNR 16	40	32	350	52	21	30	2,264	KNUX 1604	70 €
K756	S40V CKUNR 16	50	40	400	55	27	38	3,999	ISO.	87 €
K758	S45V CKUNR 16	54	45	400	60	29	41	4,924		87 €
K760	S50W CKUNR 16	63	50	450	60	35	47	0,408		105 €

Code								
	TC044 M6	TA048	TC036 M3x10	BK030	BY042	BSP030	3 Allen	



**Uç Baglama Sistemleri**  
**Insert Clamping Systems**  
**Wendeplatten klem systems**



## A-S System Boring Bars

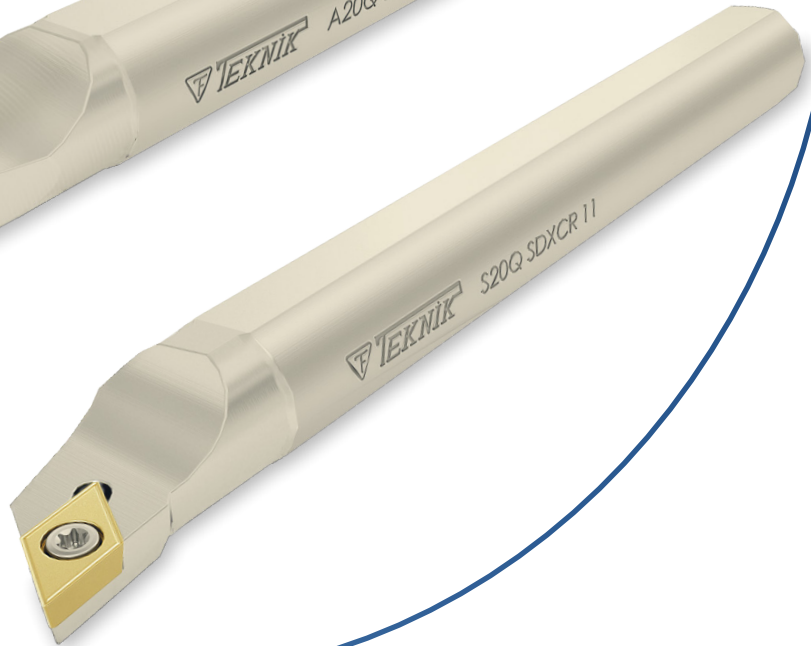
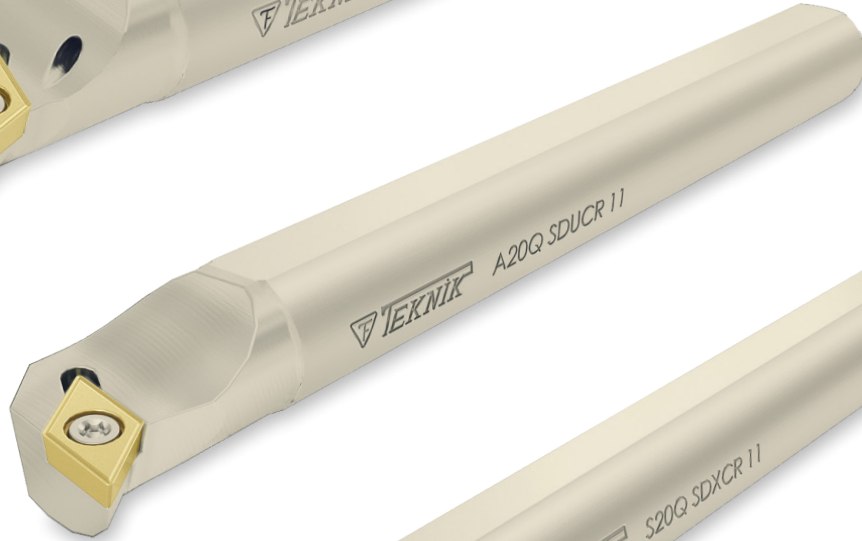
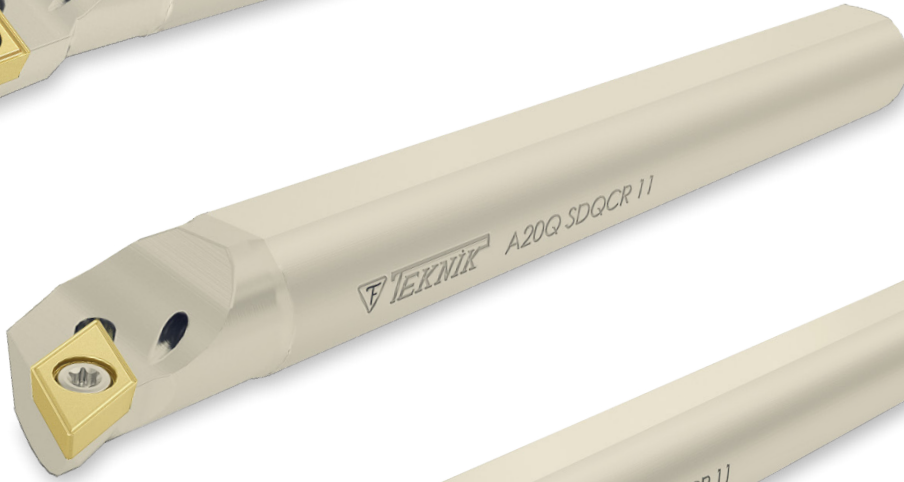
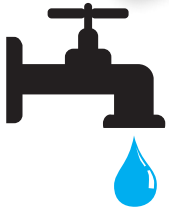

[www.teknikcuttingtools.com](http://www.teknikcuttingtools.com)



Kalite için TEKNİK çözüm  
Technical solution for quality

110-117



95° SCLCR IC  
With Coolant

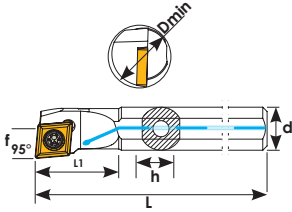

Order Code	Product Code	Dimensions (mm)								Insert	Price
		Dmin	d	L	L1	f	h				
KA102	A08H SCLCR 06	10	8	100	16	5,5	7	0,050	CCMT 0602	24 €	
KA104	A10J SCLCR 06	12	10	110	20	6	9	0,074	ISO.	25 €	
KA106	A12K SCLCR 06	16	12	125	25	9	11	0,113		25 €	
KA108	A14-16Q SCLCR 09	18	16	180	45	9,5	15	0,267	CCMT 09T3	32 €	
KA110	A16Q SCLCR 09	20	16	180	30	11	15	0,260	ISO.	32 €	
KA111	A16M SCLCR 09	20	16	150	30	11	15	0,227		32 €	
KA114	A20Q SCLCR 09	25	20	180	40	13	18	0,422		33 €	
KA116	A25R SCLCR 09	32	25	200	40	17	23	0,734		36 €	
<b>Code</b>											
KA102-KA106		TC060 M2,5x5,5				T8					
KA108 KA116		TC067 M3,5x8,5				T16					

95° SCLCR

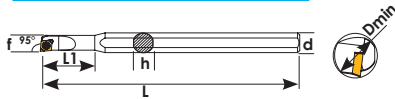
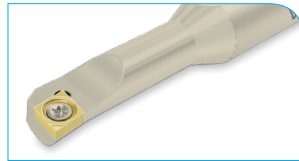

Order Code	Product Code	Dimensions (mm)								Insert	Price
		Dmin	d	L	L1	f	h				
K097	S05-08H SCLCR 03	5	8	100	15	2,5	7,3	0,046	CCMT 0301	35 €	
K098	S06-08H SCLCR 03	6	8	100	18	3	7,3	0,048	ISO.	35 €	
K099	S07-08H SCLCR 04	7	8	100	21	3,5	7,3	0,050	CCMT 0401 ISO.	35 €	
<b>Code</b>											
K097-K098		TC07 M1,6				T6					
K099		TC058 M2x4,2									

95° SCLCR

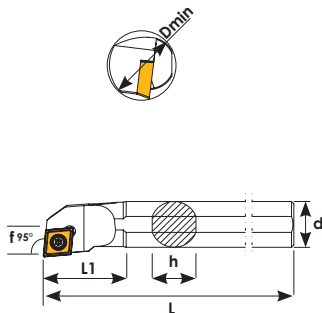

Order Code	Product Code	Dimensions (mm)								Insert	Price
		Dmin	d	L	L1	f	h				
K100	S06-08H SCLCR 06	9	8	100	25	4,3	7,3	0,052		22 €	
K102	S08H SCLCR 06	10	8	100	16	5,5	7,3	0,053	CCMT 0602	22 €	
K104	S10J SCLCR 06	12	10	110	20	6	9	0,080	ISO.	23 €	
K105	S10K SCLCR 06	12	10	125	20	6	9	0,085		23 €	
K106	S12K SCLCR 06	16	12	125	25	9	11	0,120		24 €	
K107	S12Q SCLCR 06	16	12	180	25	9	11	0,170		29 €	
K107-1	S12K SCLCR 09	16	12	125	25	9	11	0,271		24 €	
K108	S14-16Q SCLCR 09	18	16	180	45	9,5	15	0,285		29 €	
K110	S16Q SCLCR 09	20	16	180	30	11	15	0,317		29 €	
K111	S16R SCLCR 09	20	16	200	30	11	15	0,329	CCMT 09T3	31 €	
K112	S18-20Q SCLCR 09	21	20	180	38	11	18	0,436	ISO.	31 €	
K114	S20Q SCLCR 09	25	20	180	40	13	18	0,612		31 €	
K115	S20S SCLCR 09	25	20	250	40	13	18	0,780		33 €	
K116	S25R SCLCR 09	32	25	200	40	17	23	0,694		33 €	
K117	S25T SCLCR 09	32	25	300	40	17	23	1,165		36 €	
K116-1	S25S SCLCR 12	32	25	250	45	17	23	0,965	CCMT 1204 ISO.	39 €	
<b>Yedek Part</b>											
K100-K102		TC059-1 M2,5x4,7				T8					
K104-K107		TC060 M2,5x5,5									
K107-1 K117		TC067 M3,5x8,5				T15					
K116-1		TC083 M5x12				T20					

95° SCLCL IC  
With Coolant

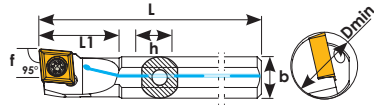
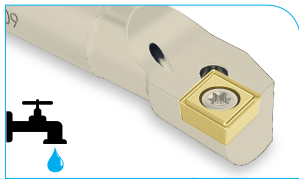

Order Code	Product Code	Dimensions (mm)							Insert	Price
		Dmin	d	L	L1	f	h			
KA232	A08H SCLCL 06	10	8	100	16	5,5	7	0,050	CCMT 0602	24 €
KA234	A10J SCLCL 06	12	10	110	20	6	9	0,074	ISO.	25 €
KA236	A12K SCLCL 06	16	12	125	25	9	11	0,113		25 €
KA238	A14-16Q SCLCL 09	18	16	180	45	9,5	15	0,271		32 €
KA239	A16M SCLCL 09	20	16	150	30	11	15	0,227	CCMT 09T3	32 €
KA240	A16Q SCLCL 09	20	16	180	30	11	15	0,260	ISO.	32 €
KA244	A20Q SCLCL 09	25	20	180	40	13	18	0,422		33 €
KA246	A25R SCLCL 09	32	25	200	40	17	23	0,734		36 €

Code			
KA232- KA236	TC060 M2,5x5,5	T8	
KA238- KA246	TC067 M3,5x8,5	T16	

95° SCLCL

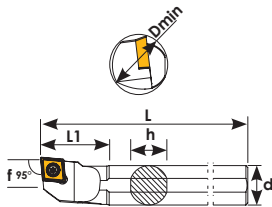
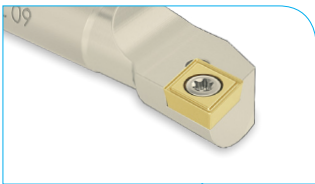

Order Code	Product Code	Dimensions (mm)							Insert	Price
		Dmin	d	L	L1	f	h			
K230	S06-08H SCLCL 06	9	8	100	25	4,3	7	0,052		22 €
K232	S08H SCLCL 06	10	8	100	16	5,5	7	0,053	CCMT 0602	22 €
K234	S10J SCLCL 06	12	10	110	20	6	9	0,080	ISO.	23 €
K236	S12K SCLCL 06	16	12	125	25	9	11	0,120		24 €
K238	S14-16Q SCLCL 09	18	16	180	45	9,5	15	0,271		29 €
K240	S16Q SCLCL 09	20	16	180	30	11	15	0,285	CCMT 09T3	29 €
K241	S16R SCLCL 09	20	16	200	30	11	15	0,317	ISO.	31 €
K244	S20Q SCLCL 09	25	20	180	40	13	18	0,436		31 €
K245	S20S SCLCL 09	25	20	250	40	13	18	0,612		33 €
K246	S25R SCLCL 09	32	25	200	40	17	23	0,780		33 €

Code			
K230- K236	TC060 M2,5x5,5	T8	
K238- K246	TC067 M3,5x8,5	T16	

93° SDUCR IC  
With Coolant

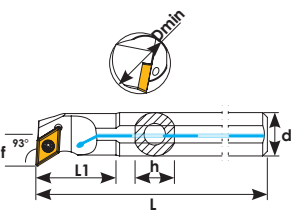

Order Code	Product Code	Dimensions (mm)							Insert	Price
		Dmin	d	L	L1	f	h			
KA120	A10J SDUCR 07	12	10	110	20	7	9	0,080	DCMT 0702	25 €
KA122	A12K SDUCR 07	16	12	125	25	9	11	0,120	ISO.	25 €
KA124	A14-16Q SDUCR 07	18	16	180	40	10,5	15	0,267		32 €
KA126	A16Q SDUCR 07	20	16	180	30	11	15	0,263		32 €
KA127	A16M SDUCR 07	20	16	150	30	11	15	0,250		32 €
KA128	A16Q SDUCR 11	20	16	180	30	11	15	0,285		32 €
KA129	A16M SDUCR 11	20	16	150	30	11	15	0,246	DCMT 11T3	32 €
KA130	A20Q SDUCR 11	25	20	180	32	13	18	0,432	ISO.	33 €
KA132	A25R SDUCR 11	32	25	200	40	17	23	0,746		36 €
KA134	A32T SDUCR 11	40	32	300	45	22	30	1,924		54 €

Code			
KA120- KA127	TC060 M2,5x5,5	T8	
KA128- KA134	TC067 M3,5x8,5	T15	

93° SDUCR

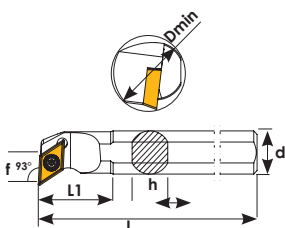

Order Code	Product Code	Dimensions (mm)							Insert	Price
		Dmin	d	L	L1	f	h			
K120	S10J SDUCR 07	12	10	110	20	7	9	0,080		23 €
K122	S12K SDUCR 07	16	12	125	25	9	11	0,120	DCMT 0702	24 €
K123	S12Q SDUCR 07	16	12	180	25	9	11	0,170	ISO.	29 €
K124	S14-16Q SDUCR 07	18	16	180	40	10,5	15	0,266		29 €
K126	S16Q SDUCR 07	20	16	180	30	11	15	0,292		29 €
K125	S14-16Q SDUCR 11	18	16	180	45	10,5	15	0,272		29 €
K128	S16Q SDUCR 11	20	16	180	30	11,5	15	0,285	DCMT 11T3	29 €
K129	S16M SDUCR 11	20	16	150	30	11	15	0,246		29 €
K130	S20Q SDUCR 11	25	20	180	32	13	18	0,435	ISO.	31 €
K132	S25R SDUCR 11	32	25	200	40	17	23	0,748		33 €
K134	S32T SDUCR 11	40	32	300	45	22	30	1,833		51 €

Code			
K120- K126	TC060 M2,5x5,5	T8	
K125- K134	TC067 M3,5x8,5	T15	

93° SDUCL IC  
With Coolant

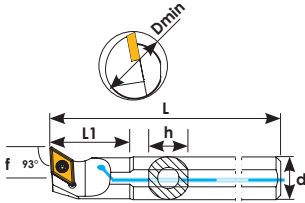

Order Code	Product Code	Dimensions (mm)								Insert	Price
		Dmin	d	L	L1	f	h	kg			
KA250	A10J SDUCL 07	12	10	110	20	7	9	0,080	DCMT 0702	25 €	
KA252	A12K SDUCL 07	16	12	125	25	9	11	0,120	ISO.	25 €	
KA254	A14-16Q SDUCL 07	18	16	180	40	10,5	15	0,267		32 €	
KA256	A16Q SDUCL 07	20	16	180	30	11	15	0,263		32 €	
KA258	A16Q SDUCL 11	20	16	180	30	11	15	0,285		32 €	
KA259	A16M SDUCL 11	20	16	150	30	11	15	0,246	DCMT 11T3	32 €	
KA260	A20Q SDUCL 11	25	20	180	32	13	18	0,432	ISO.	33 €	
KA262	A25R SDUCL 11	32	25	200	40	17	23	0,746		36 €	
KA263	A32T SDUCL 11	40	32	300	45	22	30	1,924		54 €	

Code

KA250-KA256 TC060 M2,5x5,5 T8  
KA258-KA263 TC067 M3,5x8,5 T15

93° SDUCL

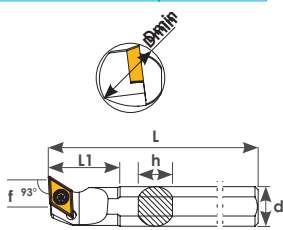
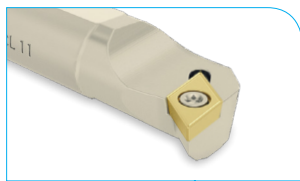

Order Code	Product Code	Dimensions (mm)								Insert	Price
		Dmin	d	L	L1	f	h	kg			
K250	S10J SDUCL 07	12	10	110	20	7	9	0,080		23 €	
K252	S12K SDUCL 07	16	12	125	25	9	11	0,120	DCMT 0702	24 €	
K254	S14-16Q SDUCL 07	18	16	180	40	10,5	15	0,266	ISO.	29 €	
K256	S16Q SDUCL 07	20	16	180	30	11	15	0,292		29 €	
K258	S16Q SDUCL 11	20	16	180	30	11	15	0,285	DCMT 11T3	29 €	
K259	S16M SDUCL 11	20	16	150	30	11	15	0,246		29 €	
K260	S20Q SDUCL 11	25	20	180	32	13	18	0,435	ISO.	31 €	
K262	S25R SDUCL 11	32	25	200	40	17	23	0,748		33 €	
K263	S32T SDUCL 11	40	32	300	45	22	30	1,833		51 €	

Code

K250-K256 TC060 M2,5x5,5 T8  
K258-K263 TC067 M3,5x8,5 T15

107,5° SDQCR IC  
With Coolant

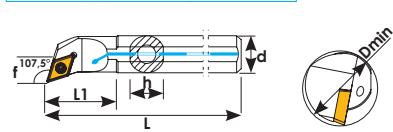
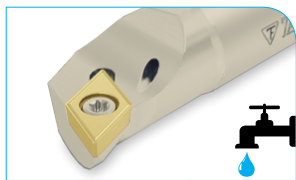

Order Code	Product Code	Dimensions (mm)								Insert	Price
		Dmin	d	L	L1	f	h	kg			
KA140	A10J SDQCR 07	12	10	110	20	7	9	0,074	DCMT 0702	25 €	
KA142	A12K SDQCR 07	16	12	125	25	9	11	0,110	ISO.	25 €	
KA143	A16M SDQCR 07	20	16	150	30	11	15	0,232		32 €	
KA144	A16Q SDQCR 07	20	16	180	30	11	15	0,282		32 €	
KA146	A16Q SDQCR 11	20	16	180	30	11	15	0,275		32 €	
KA148	A20Q SDQCR 11	25	20	180	32	13	18	0,425	DCMT 11T3	32 €	
KA150	A25R SDQCR 11	32	25	200	40	17	23	0,738	ISO.	33 €	

Code

KA140-KA144 TC060 M2,5x5,5 T8  
KA146-KA150 TC067 M3,5x8,5 T15

107,5° SDQCR

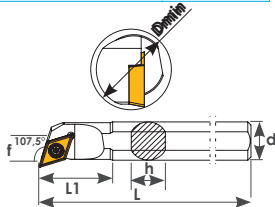

Order Code	Product Code	Dimensions (mm)								Insert	Price
		Dmin	d	L	L1	f	h	kg			
K140	S10J SDQCR 07	12	10	110	20	7	9	0,080	DCMT 0702	23 €	
K142	S12K SDQCR 07	16	12	125	25	9	11	0,120	ISO.	24 €	
K144	S16Q SDQCR 07	20	16	180	30	11	15	0,292		29 €	
K146	S16Q SDQCR 11	20	16	180	30	11	15	0,285		29 €	
K148	S20Q SDQCR 11	25	20	180	32	13	18	0,435	DCMT 11T3	31 €	
K150	S25R SDQCR 11	32	25	200	40	17	23	0,748	ISO.	33 €	
K152	S32T SDQCR 11	40	32	300	50	22	30	1,833		51 €	
K154	S40T SDQCR 11	50	40	300	50	27	38	0,268		64 €	

Code

K140-K144 TC060 M2,5x5,5 T8  
K146-K154 TC067 M3,5x8,5 T15



**107,5° SDQCL IC**  
With Coolant

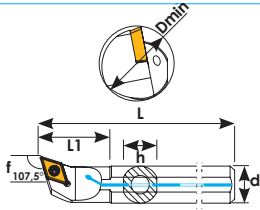

Order Code	Product Code	Dimensions (mm)							Insert	Price
		Dmin	d	L	L1	f	h			
KA270	A10J SDQCL 07	12	10	110	20	7	9	0,074	DCMT 0702	25 €
KA272	A12K SDQCL 07	16	12	125	25	9	11	0,110	ISO.	25 €
KA273	A16M SDQCL 07	20	16	150	30	11	15	0,232		32 €
KA274	A16Q SDQCL 07	20	16	180	30	11	15	0,282		32 €
KA276	A16Q SDQCL 11	20	16	180	30	11	15	0,275	DCMT 11T3	32 €
KA278	A20Q SDQCL 11	25	20	180	32	13	18	0,425	ISO.	33 €
KA280	A25R SDQCL 11	32	25	200	40	17	23	0,738		36 €

Code		
KA270-KA274	TC060 M2,5x5,5	T8
KA276-KA280	TC067 M3,5x8,5	T15

**107,5° SDQCL**

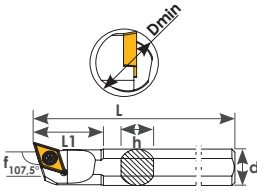

Order Code	Product Code	Dimensions (mm)							Insert	Price
		Dmin	d	L	L1	f	h			
K270	S10J SDQCL 07	12	10	110	20	7	9	0,080	DCMT 0702	23 €
K272	S12K SDQCL 07	16	12	125	25	9	11	0,120	ISO.	24 €
K274	S16Q SDQCL 07	20	16	180	30	11	15	0,292		29 €
K276	S16Q SDQCL 11	20	16	180	30	11	15	0,285		29 €
K278	S20Q SDQCL 11	25	20	180	32	13	18	0,435	DCMT 11T3	31 €
K280	S25R SDQCL 11	32	25	200	40	17	23	0,748	ISO.	33 €
K281	S32T SDQCL 11	40	32	300	50	22	30	1,833		51 €

Code		
K270-K274	TC060 M2,5x5,5	T8
K276-K281	TC067 M3,5x8,5	T15

**120° SDXCR**

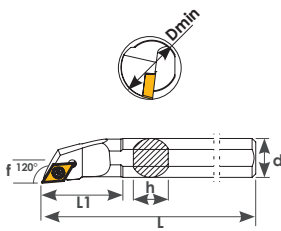
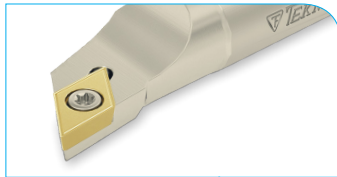

Order Code	Product Code	Dimensions (mm)							Insert	Price
		Dmin	d	L	L1	f	h			
K469	S10J SDXCR 07	12	10	110	25	5,5	9	0,080	DCMT 0702	23 €
K470	S12K SDXCR 07	16	12	125	30	9	11	0,120	ISO.	24 €
K471	S16Q SDXCR 11	20	16	180	40	11	15	0,285		29 €
K472	S20Q SDXCR 11	25	20	180	40	13	18	0,435		31 €
K473	S25R SDXCR 11	32	25	200	50	13,5	23	0,748	DCMT 11T3	33 €
K474	S32T SDXCR 11	40	32	300	55	17	30	1,833	ISO.	51 €
K475	S40T SDXCR 11	50	40	300	55	21	38	0,268		64 €

Code		
K469-K470	TC060 M2,5x5,5	T8
K471-K475	TC067 M3,5x8,5	T15

**62,5° SD-CR**

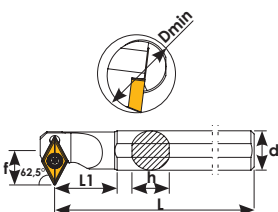
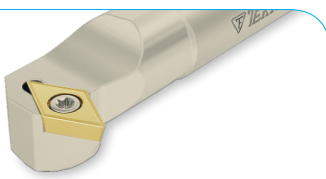

Order Code	Product Code	Dimensions (mm)							Insert	Price
		Dmin	d	L	L1	f	h			
K168	S10J SD-CR 07	14	10	110	25	8,2	9	0,082	DCMT 0702	23 €
K170	S12K SD-CR 07	16	12	125	25	9	11	0,122	ISO.	24 €
K173	S16Q SD-CR 07	20	16	180	35	12	15	0,280		29 €
K172	S16Q SD-CR 11	23	16	180	35	14	15	0,288		29 €
K174	S20Q SD-CR 11	25	20	180	32	15	18	0,443	DCMT 11T3	31 €
K176	S25R SD-CR 11	32	25	200	35	17	23	0,771	ISO.	33 €
K178	S32T SD-CR 11	40	32	300	55	23	30	1,865		51 €

Code		
K168-K173	TC060 M2,5x5,5	T8
K172-K178	TC067 M3,5x8,5	T15

5° SDZCR

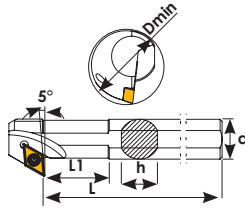
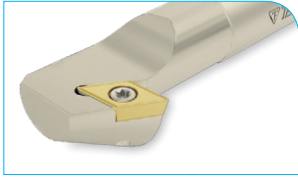

Order Code	Product Code	Dimensions (mm)							Insert	Price
		Dmin	d	L	L1	f	h			
K190	S12K SDZCR 07	18	12	125	20	11	11	0,128	DCMT 0702 ISO	33 €
K192	S16Q SDZCR 11	23	16	180	25	14	15	0,302		37 €
K194	S20Q SDZCR 11	30	20	180	32	19	18	0,498	DCMT 11T3	40 €
K196	S25R SDZCR 11	35	25	200	32	22	23	0,816	ISO	44 €
<b>Code</b>										
K190		TC060 M2,5x5,5		T8						
K192-K196		TC067 M3,5x8,5		T15						

60° ST-CR

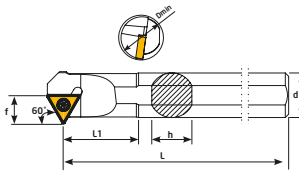
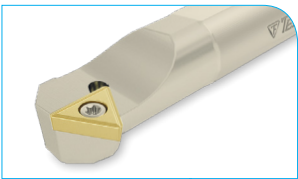

Order Code	Product Code	Dimensions (mm)							Insert	Price
		Dmin	d	L	L1	f	h			
K180	S16Q ST-CR 16	20	16	180	40	11	15	0,817	TCMT 16T3	29 €
K182	S20Q ST-CR 16	25	20	180	40	13	18	0,432	ISO	31 €
K183	S25R ST-CR 16	32	25	200	50	17	23	0,772		33 €
K183-1	S32T ST-CR 16	30	32	300	60	22	30	1,961		51 €
<b>Code</b>										
		TC067 M3,5x8,5		T15						

90° STFRCR IC With Coolant

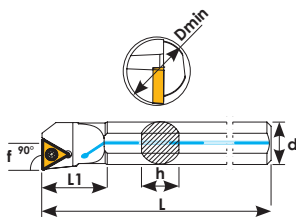

Order Code	Product Code	Dimensions (mm)							Insert	Price
		Dmin	d	L	L1	f	h			
KA160	A12K STFRCR 11	16	12	125	25	9	11	0,053	TCMT 1102	25 €
KA161	A16Q STFRCR 11	20	16	180	30	11	15	0,289	ISO.	32 €
KA162	A16Q STFRCR 16	20	16	180	30	11	15	0,287		32 €
KA164	A20Q STFRCR 16	25	20	180	32	13	18	0,440	TCMT 16T3	33 €
KA166	A25R STFRCR 16	32	25	200	40	16	23	0,754	ISO.	36 €
<b>Code</b>										
KA160-KA161		TC060 M2,5x5,5		T8						
KA162-KA166		TC067 M3,5x8,5		T16						

90° STFRCR

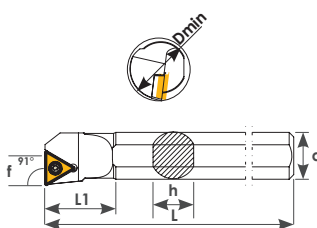
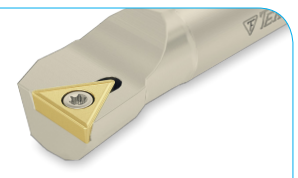

Order Code	Product Code	Dimensions (mm)							Insert	Price
		Dmin	d	L	L1	f	h			
K160	S12K STFRCR 11	16	12	125	25	9	11	0,118	TCMT 1102	24 €
K161	S16Q STFRCR 11	20	16	180	30	11	15	0,290	ISO.	29 €
K162	S16Q STFRCR 16	20	16	180	30	11	15	0,287	TCMT 16T3	29 €
K164	S20Q STFRCR 16	25	20	180	32	13	18	0,440	ISO.	31 €
K166	S25R STFRCR 16	32	25	200	40	16	23	0,773		33 €
<b>Code</b>										
K160-K161		TC060 M2,5x5,5		T8						
K162-K166		TC067 M3,5x8,5		T15						

90° STFCL IC With Coolant

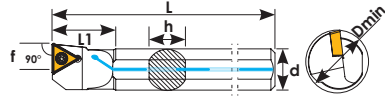
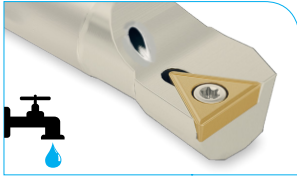

Order Code	Product Code	Dimensions (mm)							Insert	Price
		Dmin	d	L	L1	f	h			
KA184	A12K STFCL 11	16	12	125	25	9	11	0,053	TCMT 1102	25 €
KA185	A16Q STFCL 11	20	16	180	30	11	15	0,289	ISO.	32 €
KA186	A16Q STFCL 16	20	16	180	30	11	15	0,287		32 €
KA187	A20Q STFCL 16	25	20	180	32	13	18	0,440	TCMT 16T3	33 €
KA188	A25R STFCL 16	32	25	200	40	16	23	0,754	ISO.	36 €

Code			
KA184-KA185	TC060 M2,5x5,5	T8	
KA186-KA188	TC067 M3,5x8,5	T16	

90° STFCL

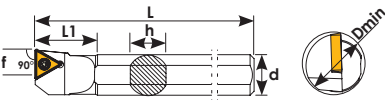
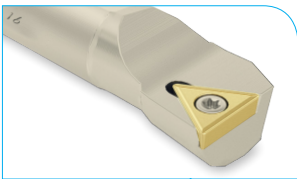

Order Code	Product Code	Dimensions (mm)							Insert	Price
		Dmin	d	L	L1	f	h			
K184	S12K STFCL 11	16	12	125	25	9	11	0,118	TCMT 1102	24 €
K185	S16Q STFCL 11	20	16	180	30	11	15	0,290	ISO.	29 €
K186	S16Q STFCL 16	20	16	180	30	11	15	0,287		29 €
K187	S20Q STFCL 16	25	20	180	32	13	18	0,440	TCMT 16T3	31 €
K188	S25R STFCL 16	32	25	200	40	16	23	0,773	ISO.	33 €

Code			
K184-K185	TC060 M2,5x5,5	T8	
K186-K188	TC067 M3,5x8,5	T15	

93° SVUBR IC With Coolant

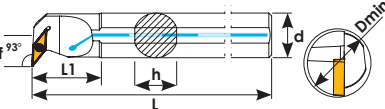
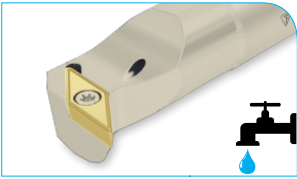

Order Code	Product Code	Dimensions (mm)							Insert	Price
		Dmin	d	L	L1	f	h			
KA208	A25R SVUBR 16	32	25	200	40	17	23	0,723	VBMT 1604	43 €
KA209	A32T SVUBR 16	40	32	300	50	22	30	1,909	ISO.	63 €

Code			
	TC074 M4x10	T15	

93° SVUBR

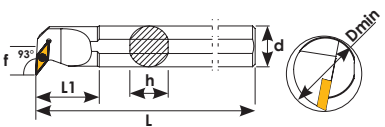
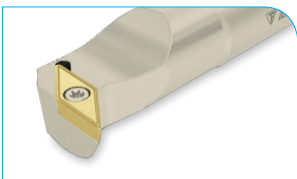

Order Code	Product Code	Dimensions (mm)							Insert	Price
		Dmin	d	L	L1	f	h			
K206	S16Q SVUBR 11	20	16	180	30	11	15	0,278	VBMT 1103	34 €
K207	S20Q SVUBR 11	25	20	180	32	13	18	0,700	ISO.	37 €
K208	S25R SVUBR 16	32	25	200	40	17	23	0,730		40 €
K209	S32T SVUBR 16	40	32	300	50	22	30	1,822	VBMT 1604	58 €
K210	S40T SVUBR 16	50	40	300	50	27	38	2,836	ISO.	67 €

Code			
	TC061 M2,5x6,5 TC074 M4x10	T8 T15	

93° SVUBL IC With Coolant

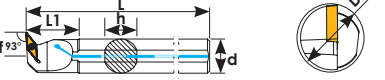
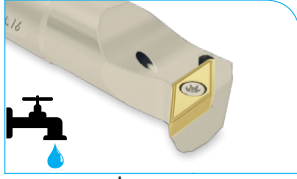

Order Code	Product Code	Dimensions (mm)							Insert	Price
		Dmin	d	L	L1	f	h			
KA286	A25R SVUBL 16	32	25	200	40	17	23	0,723	VBMT 1604	43 €
KA288	A32T SVUBL 16	40	32	300	50	22	30	1,909	ISO.	63 €

Code			
	TC074 M4x10	T15	

### 93° SVUBL

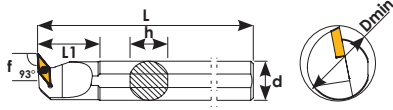
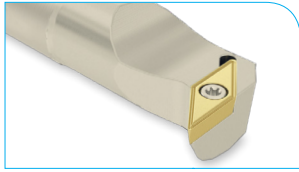

Order Code	Product Code	Dimensions (mm)							Insert	Price
		Dmin	d	L	L1	f	h			
K282	S16Q SVUBL 11	20	16	180	30	11	15	0,278	VBMT 1103	34 €
K284	S20Q SVUBL 11	25	20	180	32	13	18	0,700	ISO.	37 €
K286	S25R SVUBL 16	32	25	200	40	17	23	0,730	VBMT 1604	40 €
K288	S32T SVUBL 16	40	32	300	50	22	30	1,822	ISO.	58 €
<b>Code</b>										
K282-K284		TC061 M2,5x6,5				T8				
K286-K288		TC074 M4x10				T15				

### 93° SVUCR IC With Coolant

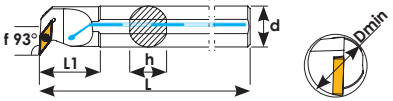
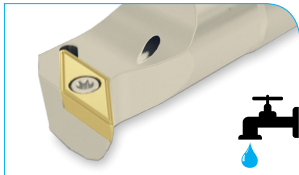

Order Code	Product Code	Dimensions (mm)							Insert	Price
		Dmin	d	L	L1	f	h			
KA211	A16Q SVUCR 11	20	16	180	30	11	15	0,268	VCMT 1103	36 €
KA212	A20Q SVUCR 11	25	20	180	32	13	18	0,689	ISO.	40 €
KA213	A25R SVUCR 16	32	25	200	40	17	23	0,720	VCMT 1604	43 €
KA214	A32T SVUCR 16	40	32	300	50	22	30	1,812	ISO.	63 €
<b>Code</b>										
KA211-KA212		TC061 M2,5x6,5				T8				
KA213-KA214		TC074 M4x10				T15				

### 93° SVUCR

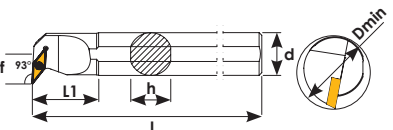
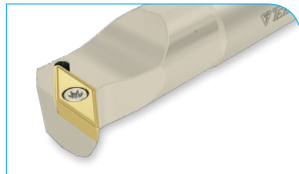

Order Code	Product Code	Dimensions (mm)							Insert	Price
		Dmin	d	L	L1	f	h			
K211	S16Q SVUCR 11	20	16	180	30	11	15	0,280	VCMT 1103	34 €
K212	S20Q SVUCR 11	25	20	180	32	13	18	0,432	ISO.	37 €
K213	S25R SVUCR 16	32	25	200	40	17	23	0,771		40 €
K214	S32T SVUCR 16	40	32	300	50	22	30	1,833	VCMT 1604	58 €
K215	S40T SVUCR 16	50	40	300	55	27	38	2,807	ISO.	67 €
<b>Code</b>										
K211-K212		TC061 M2,5x6,5				T8				
K213-K215		TC074 M4x10				T15				

### 93° SVUCL IC With Coolant

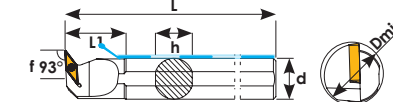
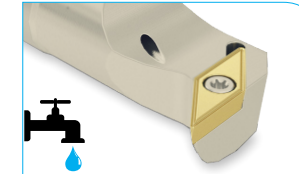

Order Code	Product Code	Dimensions (mm)							Insert	Price
		Dmin	d	L	L1	f	h			
KA300	A16Q SVUCL 11	20	16	180	30	11	15	0,268	VCMT 1103	36 €
KA302	A20Q SVUCL 11	25	20	180	32	13	18	0,689	ISO.	40 €
KA304	A25R SVUCL 16	32	25	200	40	17	23	0,720	VCMT 1604	43 €
KA306	A32T SVUCL 16	40	32	300	50	22	30	1,812	ISO.	63 €
<b>Code</b>										
KA300-KA302		TC061 M2,5x6,5				T8				
KA304-KA306		TC074 M4x10				T15				

### SVUCL

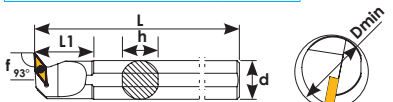
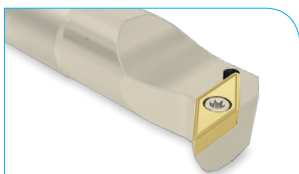

Order Code	Product Code	Dimensions (mm)							Insert	Price
		Dmin	d	L	L1	f	h			
K300	S16Q SVUCL 11	20	16	180	30	11	15	0,280	VCMT 1103	34 €
K302	S20Q SVUCL 11	25	20	180	32	13	18	0,432	ISO.	37 €
K304	S25R SVUCL 16	32	25	200	40	17	23	0,771	VCMT 1604	40 €
K306	S32T SVUCL 16	40	32	300	50	22	30	1,833	ISO.	58 €
<b>Code</b>										
K300-K302		TC061 M2,5x6,5				T8				
K304-K306		TC074 M4x10				T15				

**107,5° SVQCR IC With Coolant**

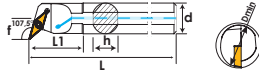
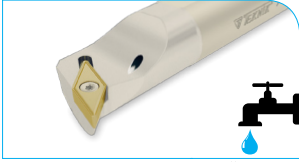

Order Code	Product Code	Dimensions (mm)							Insert	Price
		Dmin	d	L	L1	f	h	kg		
KA221	A16Q SVQCR 11	20	16	180	30	11	15	0,271	VCMT 1103	36 €
KA222	A20Q SVQCR 11	25	20	180	30	13	18	1,752	ISO.	40 €

**107,5° SVQCR**

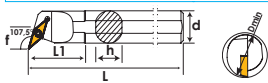
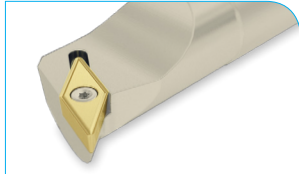

Order Code	Product Code	Dimensions (mm)							Insert	Price
		Dmin	d	L	L1	f	h	kg		
K221	S16Q SVQCR 11	20	16	180	30	11	15	0,281	VCMT 1103	34 €
K222	S20Q SVQCR 11	25	20	180	30	13	18	1,762	ISO.	37 €
K223	S25R SVQCR 16	32	25	200	50	17	23	0,728		40 €
K224	S32T SVQCR 16	40	32	300	50	22	30	1,786	VCMT 1604	58 €
K225	S40T SVQCR 16	50	40	300	55	27	38		ISO.	67 €

**Code**  
 K221-K222 TC061 M2,5x6,5 T8  
 K223-K225 TC074 M4x10 T15

**107,5° SVQCL IC With Coolant**

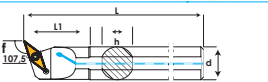

Order Code	Product Code	Dimensions (mm)							Insert	Price
		Dmin	d	L	L1	f	h	kg		
KA319	A16Q SVQCL 11	20	16	180	30	11	15	0,271	VCMT 1103	36 €
KA320	A20Q SVQCL 11	25	20	180	30	13	18	1,752	ISO.	40 €

**107,5° SVQCL**

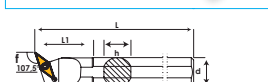
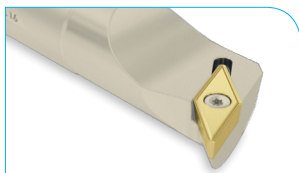

Order Code	Product Code	Dimensions (mm)							Insert	Price
		Dmin	d	L	L1	f	h	kg		
K319	S16Q SVQCL 11	20	16	180	30	11	15	0,281	VCMT 1103	34 €
K320	S20Q SVQCL 11	25	20	180	30	13	18	1,762	ISO.	37 €
K322	S25R SVQCL 16	32	25	200	50	17	23	0,728	VCMT 1604	40 €
K324	S32T SVQCL 16	40	32	300	50	22	30	1,786	ISO.	58 €

**Code**  
 K319-K320 TC061 M2,5x6,5 T8  
 K322-K324 TC074 M4x10 T15

**107,5° SVQBR**

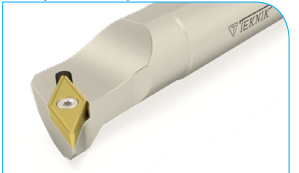

Order Code	Product Code	Dimensions (mm)							Insert	Price
		Dmin	d	L	L1	f	h	kg		
K216	S16Q SVQBR 11	20	16	180	30	11	15	0,276	VBMT 1103	34 €
K217	S20Q SVQBR 11	25	20	180	30	13	18	0,422	ISO.	37 €
K218	S25R SVQBR 16	32	25	200	50	17	23	0,725		40 €
K219	S32T SVQBR 16	40	32	300	50	22	30	1,790	VBMT 1604	58 €
K220	S40T SVQBR 16	50	40	300	55	27	38	2,765	ISO.	67 €

**Code**  
 K216-K217 TC061 M2,5x6,5 T8  
 K218-K220 TC074 M4x10 T15

**107,5° SVQBL**

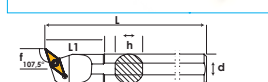
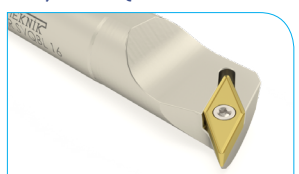

Order Code	Product Code	Dimensions (mm)							Insert	Price
		Dmin	d	L	L1	f	h	kg		
K310	S16Q SVQBL 11	20	16	180	30	11	15	0,276	VBMT 1103	34 €
K312	S20Q SVQBL 11	25	20	180	30	13	18	0,422	ISO.	37 €
K314	S25R SVQBL 16	32	25	200	50	17	23	0,725		40 €
K316	S32T SVQBL 16	40	32	300	50	22	30	1,790	VBMT 1604	58 €
K318	S40T SVQBL 16	50	40	300	55	27	38	2,765	ISO.	67 €

**Code**  
 K310-K312 TC061 M2,5x6,5 T8  
 K314-K318 TC074 M4x10 T15



**Kalite İin Teknik özüm**  
Technical solution for quality



[www.teknikcuttingtools.com](http://www.teknikcuttingtools.com)

**U Baglama Sistemleri Insert Clamping Systems Wendeplatten klem systems**

## Carbide Boring Bars / Set

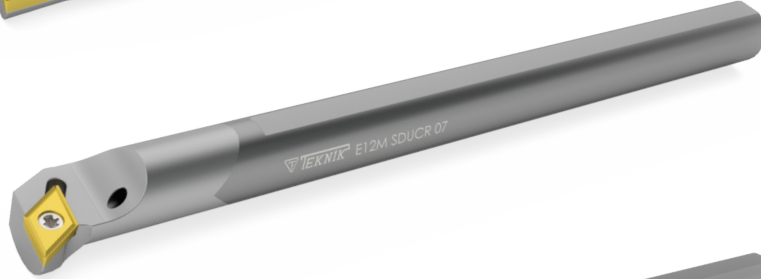
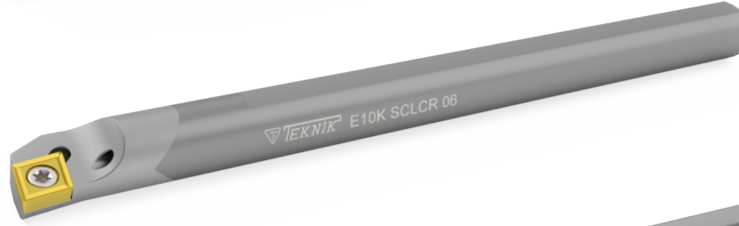
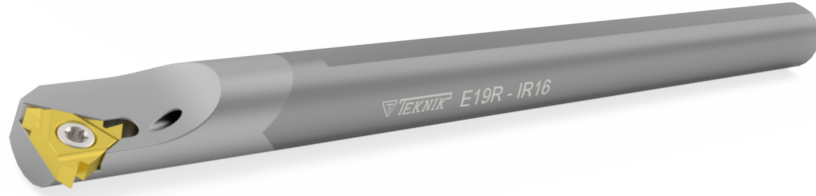
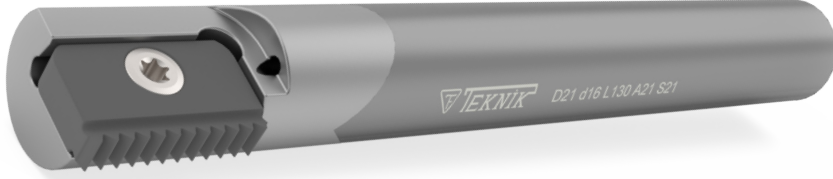

[www.teknikcuttingtools.com](http://www.teknikcuttingtools.com)



Kalite için TEKNIK çözüm  
Technical solution for quality

120-122



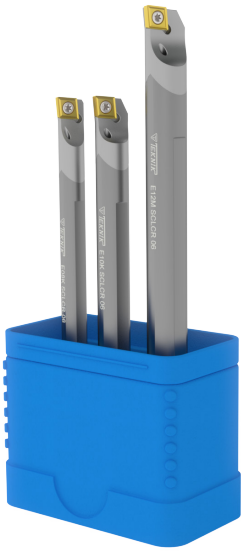

*E-SCLCR SET*

Order Code	Product Code in Set	Insert	Price
İPS30 	E08K SCLCR 06	CCMT 0602	<b>391 €</b>
	E10K SCLCR 06	ISO.	
	E12M SCLCR 06		

*E-SCLCL SET*

Order Code	Product Code in Set	Insert	Price
İPS31 	E08K SCLCL 06	CCMT 0602	<b>391 €</b>
	E10K SCLCL 06	ISO.	
	E12M SCLCL 06		

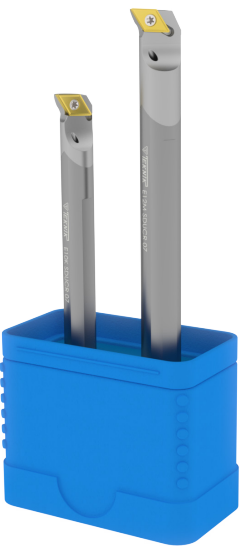

*E-SDUCR SET*

Order Code	Product Code in Set	Insert	Price
İPS32 	E10K SDUCR 07	DCMT 0702	<b>270 €</b>
	E12M SDUCR 07	ISO.	

*E-SDUCL SET*

Order Code	Product Code in Set	Insert	Price
İPS33 	E10K SDUCL 07	DCMT 0702	<b>270 €</b>
	E12M SDUCL 07	ISO.	



*E-SDQCR SET*

Order Code	Product Code in Set	Insert	Price
İPS34 	E10K SDQCR 07	DCMT 0702	<b>270 €</b>
	E12M SDQCR 07	ISO.	

*E-SDQCL SET*

Order Code	Product Code in Set	Insert	Price
İPS35 	E10K SDQCL 07	DCMT 0702	<b>270 €</b>
	E12M SDQCL 07	ISO.	



95° E-SCLCR IC

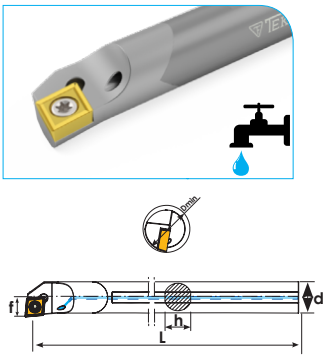

Order Code	Product Code	Dimensions (mm)						kg	Insert	Price
		Dmin	d	L	f	h				
KE10	E08K SCLCR 06	10	8	125	5	7,5	0,050	CCMT 0602	119 €	
KE11	E10K SCLCR 06	12	10	125	6	9,5	0,100	ISO.	134 €	
KE12	E12M SCLCR 06	16	12	150	7	11,5	0,200		139 €	
KE13	E16R SCLCR 09	20	16	200	10	15,5	0,500	CCMT 09T3	253 €	
KE14	E20S SCLCR 09	25	20	250	13	19,5	0,950	ISO	429 €	
<b>Code</b>										
		KE10-KE12 TC060 M2,5x5,5						T8		
		KE13-KE14 TC067 M3,5x8,5						T15		

95° E-SCLCL IC

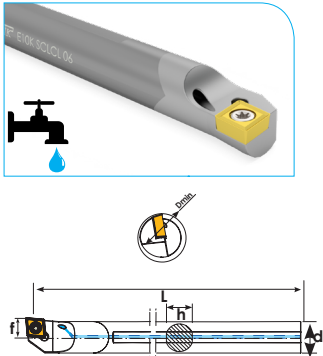

Order Code	Product Code	Dimensions (mm)						kg	Insert	Price
		Dmin	d	L	f	h				
KE17	E08K SCLCL 06	10	8	125	5	7,5	0,050	CCMT 0602	119 €	
KE18	E10K SCLCL 06	12	10	125	6	9,5	0,100	ISO.	134 €	
KE19	E12M SCLCL 06	16	12	150	7	11,5	0,200		139 €	
KE20	E16R SCLCL 09	20	16	200	10	15,5	0,500	CCMT 09T3	253 €	
KE21	E20S SCLCL 09	25	20	250	13	19,5	0,950	ISO	429 €	
<b>Code</b>										
		KE17-KE19 TC060 M2,5x5,5						T8		
		KE20-KE21 TC067 M3,5x8,5						T15		

93° E-SDUCR IC

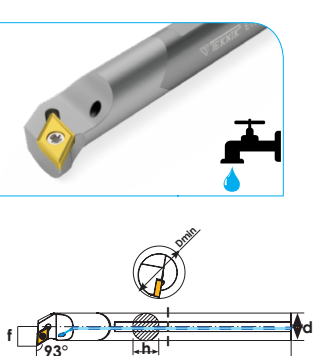

Order Code	Product Code	Dimensions (mm)						kg	Insert	Price
		Dmin	d	L	f	h				
KE30	E10K SDUCR 07	13	10	125	7	9,5	0,050	DCMT 0702	134 €	
KE31	E12M SDUCR 07	16	12	150	9	11,5	0,100	ISO.	139 €	
KE32	E16R SDUCR 07	20	16	200	11	15,5	0,200		253 €	
KE33	E16R SDUCR 11	20	16	200	11	15,5	0,500	DCMT 11T3	253 €	
KE34	E20S SDUCR 11	25	20	250	13	19,5	0,950	ISO	429 €	
<b>Code</b>										
		KE30-KE32 TC060 M2,5x5,5						T8		
		KE33-KE34 TC067 M3,5x8,5						T15		

93° E-SDUCL IC

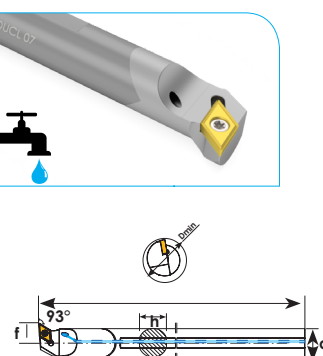

Order Code	Product Code	Dimensions (mm)						kg	Insert	Price
		Dmin	d	L	f	h				
KE40	E10K SDUCL 07	13	10	125	7	9,5	0,050	DCMT 0702	134 €	
KE41	E12M SDUCL 07	16	12	150	9	11,5	0,100	ISO.	139 €	
KE42	E16R SDUCL 07	20	16	200	11	15,5	0,200		253 €	
KE43	E16R SDUCL 11	20	16	200	11	15,5	0,500	DCMT 11T3	253 €	
KE44	E20S SDUCL 11	25	20	250	13	19,5	0,950	ISO	429 €	
<b>Code</b>										
		KE40-KE42 TC060 M2,5x5,5						T8		
		KE43-KE44 TC067 M3,5x8,5						T15		

107,5° E-SDQCR IC

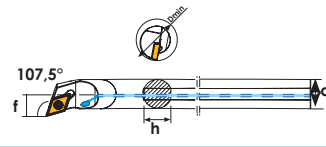
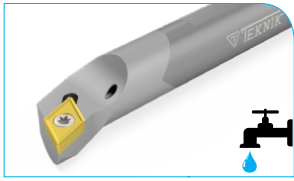

Order Code	Product Code	Dimensions (mm)						Insert	Price
		Dmin	d	L	f	h			
KE50	E10K SDQCR 07	13	10	125	7	9,5	0,050	DCMT 0702	134 €
KE51	E12M SDQCR 07	16	12	150	9	11,5	0,100	ISO	139 €
KE52	E16R SDQCR 07	20	16	200	11	15,5	0,200		253 €
KE53	E16R SDQCR 11	20	16	200	11	15,5	0,500	DCMT 11T3	253 €
KE54	E20S SDQCR 11	25	20	250	13	19,5	0,950	ISO	429 €
<b>Code</b>									
KE50-KE52		TC060 M2,5x5,5		T8					
KE53-KE54		TC067 M3,5x8,5		T15					

107,5° E-SDQCL IC

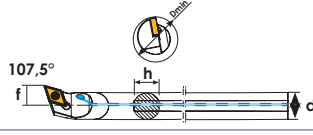
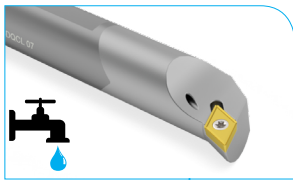

Order Code	Product Code	Dimensions (mm)						Insert	Price
		Dmin	d	L	f	h			
KE60	E10K SDQCL 07	13	10	125	7	9,5	0,050	DCMT 0702	134 €
KE61	E12M SDQCL 07	16	12	150	9	11,5	0,100	ISO	139 €
KE62	E16R SDQCL 07	20	16	200	11	15,5	0,200		253 €
KE63	E16R SDQCL 11	20	16	200	11	15,5	0,500	DCMT 11T3	253 €
KE64	E20S SDQCL 11	25	20	250	13	19,5	0,950	ISO	429 €
<b>Code</b>									
KE60-KE62		TC060 M2,5x5,5		T8					
KE63-KE64		TC067 M3,5x8,5		T15					

Carbide Internal Threading Holder/R With Coolant

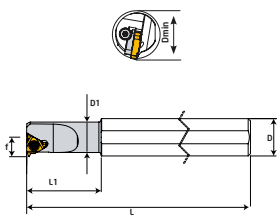
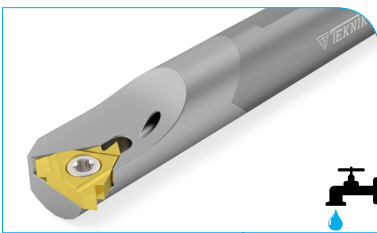

Order Code	Product Code	Dimensions (mm)						Insert	Price
		D	L	L1	f	Dmin			
KE70	E06H - IR06	6	100	26	4,3	6	0,024	6 IR	107 €
KE71	E08K - IR08	8	125	31	5,3	7,8	0,045	8 IR	119 €
KE72	E10M - IR11	10	150	-	7,4	12	0,085	11 IR	139 €
KE73	E12P - IR11	12	170	-	8,4	15	0,150	11 IR	160 €
KE74	E16R - IR16	16	200	-	11,7	19	0,260	16 IR	253 €
KE75	E20S - IR16	20	250	-	13,7	24	0,560	16 IR	429 €
KE76	E25S - IR16	25	250	-	16,2	29	0,900	16 IR	605 €
KE78	E20S - IR22	20	250	-	15,6	24,5	0,570	22 IR	429 €
<b>Code</b>									
KE70		TC058-1M2x4,2		--		--		T6	
KE71		TC058 M2x4,6		--		--		T8	
KE72-KE72		TC060 M2,5x5,5		--		--		T8	
KE74		TC067 M3,5x8,5		--		--		T15	
KE75-KE76		TC068 M3,5x11		TA060		BSP010		TC062 M3	
KE78		TC078 M4x11		--		--		T15	

Carbide Threa Cutting Tool With Coolant

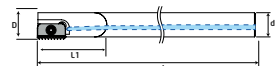

Order Code	Product Code	Dimensions (mm)						Insert	Price
		A	D	d	L	L1			
KE90	D9,9 d08 L125 A12 S12	12	9,9	8	125	-	0,049	S12	160 €
KE91	D13,2 d10 L110 A14 S14	14	13,2	10	110	-	0,067	S14	176 €
KE92	D13,2 d10 L155 A14 S14	14	13,2	10	155	-	0,100	S14	204 €
KE93	D15,2 d12 L175 A14 S14	14	15,2	12	175	-	0,167	S14	215 €
KE94	D21 d16 L130 A21 S21	21	21	16	130	-	0,212	S21	242 €
KE95	D21 d16 L200 A21 S21	21	21	16	200	-	0,327	S21	303 €
<b>Code</b>									
KE90		TC092 M2,5x5,5		--		--		T8	
KE91-KE93		TC093 M2,5x7		--		--		T15	
KE94-KE95		TC074 M4x10		--		--		T15	

## Boring Bars Set



[www.teknikcuttingtools.com](http://www.teknikcuttingtools.com)



Kalite için TEKNIK çözüm  
Technical solution for quality

124-125







### SCLCR SET

Order Code	Product Code in Set	Insert	Price
İPS01 	A08H SCLCR 06	CCMT 0602	97 €
	A10J SCLCR 06	ISO.	
	A12K SCLCR 06		
	A16M SCLCR 09	CCMT 09T3	

### SCLCL SET

Order Code	Product Code in Set	Insert	Price
İPS04 	A08H SCLCL 06	CCMT 0602	97 €
	A10J SCLCL 06	ISO.	
	A12K SCLCL 06		
	A16M SCLCL 09	CCMT 09T3	

### SDUCR SET

Order Code	Product Code in Set	Insert	Price
İPS02 	A10J SDUCR 07	DCMT 0702	75 €
	A12K SDUCR 07	ISO.	
	A16M SDUCR 07		

### SDUCL SET

Order Code	Product Code in Set	Insert	Price
İPS05 	A10J SDUCL 07	DCMT 0702	75 €
	A12K SDUCL 07	ISO.	
	A16M SDUCL 07		



### SDQCR SET

Order Code	Product Code in Set	Insert	Price
İPS03 	A10J SDQCR 07	DCMT 0702	75 €
	A12K SDQCR 07	ISO.	
	A16M SDQCR 07		

### SDQCL SET

Order Code	Product Code in Set	Insert	Price
İPS06 	A10J SDQCL 07	DCMT 0702	75 €
	A12K SDQCL 07	ISO.	
	A16M SDQCL 07		



**SCLCR SET**

Order Code	Product Code in Set	Insert	Price
İPS20	S08H SCLCR 06	CCMT 0602	87 €
	S10J SCLCR 06	ISO.	
	S12K SCLCR 06		
	S16M SCLCR 09	CCMT 09T3	

**SCLCL SET**

Order Code	Product Code in Set	Insert	Price
İPS21	S08H SCLCL 06	CCMT 0602	87 €
	S10J SCLCL 06	ISO.	
	S12K SCLCL 06		
	S16M SCLCL 09	CCMT 09T3	

**SDUCR SET**

Order Code	Product Code in Set	Insert	Price
İPS22	S10J SDUCR 07	DCMT 0702	67 €
	S12K SDUCR 07	ISO.	
	S16M SDUCR 11	DCMT 11T3	

**SDUCL SET**

Order Code	Product Code in Set	Insert	Price
İPS23	S10J SDUCL 07	DCMT 0702	67 €
	S12K SDUCL 07	ISO.	
	S16M SDUCL 11	DCMT 11T3	



**SDQCR SET**

Order Code	Product Code in Set	Insert	Price
İPS24	S10J SDQCR 07	DCMT 0702	67 €
	S12K SDQCR 07	ISO.	
	S16M SDQCR 11	DCMT 11T3	

**SDQCL SET**

Order Code	Product Code in Set	Insert	Price
İPS25	S10J SDQCL 07	DCMT 0702	67 €
	S12K SDQCL 07	ISO.	
	S16M SDQCL 11	DCMT 11T3	

**Kalite için TEKNİK çözüm**  
**Technical solution for quality**



# Indexable Insert Drills



[www.teknikcuttingtools.com](http://www.teknikcuttingtools.com)



Kalite için TEKNİK çözüm  
Technical solution for quality

128-137



Adaptor Indexable Insert Drill

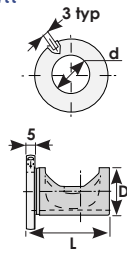

Order Code	Product Code	Dimensions (mm)			Price
		D	d	L	
UA10	D25 d20 L46	25	20	46,5	50 €
UA12	D32 d25 L47	32	25	47	50 €
UA14	D40 d32 L57	40	32	57	50 €

D2 WCM\_

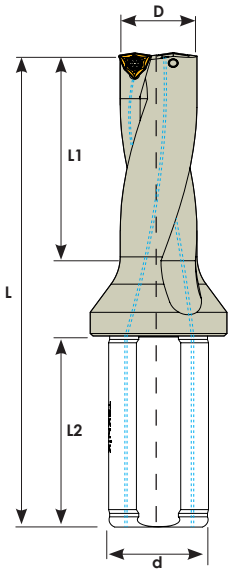
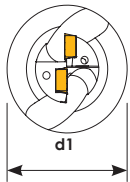
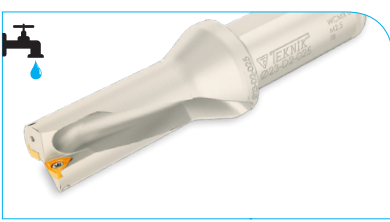

Order Code	Product Code	Dimensions (mm)							Insert	Price
		D	d	d1	L	L1	L2			
U104	16 D2 WCM_03	16	25	34	108	32	56	0,294	WCM_0302	103 €
U105	17 D2 WCM_03	17	25	34	110	34	56	0,293	KRLY	103 €
U106	18 D2 WCM_03	18	25	34	113	36	56	0,303		103 €
U107	19 D2 WCM_03	19	25	34	115	38	56	0,312		103 €
U108	20 D2 WCM_04	20	25	34	119	40	56	0,327		113 €
U110	21 D2 WCM_04	21	25	34	121	42	56	0,340	WCM_0402	113 €
U112	22 D2 WCM_04	22	25	34	123	44	56	0,345	KRLY	113 €
U114	23 D2 WCM_04	23	25	34	127	46	56	0,370		113 €
U116	24 D2 WCM_05	24	25	34	130	48	56	0,390		117 €
U118	25 D2 WCM_05	25	25	34	133	50	56	0,420		117 €
U120	26 D2 WCM_05	26	25	34	135	52	56	0,420	WCM_0503	117 €
U122	27 D2 WCM_05	27	25	34	137	54	56	0,450	KRLY	117 €
U124	28 D2 WCM_05	28	25	39	140	56	56	0,491		117 €
U126	29 D2 WCM_05	29	25	39	142	58	56	0,515		117 €
U128	30 D2 WCM_06	30	32	44	151	60	58	0,755		120 €
U130	31 D2 WCM_06	31	32	44	154	62	58	0,775		120 €
U132	32 D2 WCM_06	32	32	44	156	64	58	0,802		120 €
U134	33 D2 WCM_06	33	32	44	159	66	58	0,845	WCM_06T3	120 €
U136	34 D2 WCM_06	34	32	44	161	68	58	0,851	KRLY	120 €
U137	35 D2 WCM_06	35	32	44	164	70	58	0,900		124 €
U138	36 D2 WCM_06	36	32	44	167	72	58	0,970		124 €
U139	37 D2 WCM_06	37	32	44	170	74	58	0,875		124 €
U140	38 D2 WCM_06	38	32	44	173	76	58	0,975		124 €
U141	39 D2 WCM_06	39	32	44	175	78	58	1,006		124 €
U142	40 D2 WCM_06	40	32	44	178	80	58	1,007		124 €

Code

U104-U114	TC060 M2,5x5,5	T8	
U116-U126	TC065 M3x7	T8	
U128-U142	TC067 M3,5x8,5	T10	

Compatible with KRLY insert. / Kompatibel für KRLY WP



D3 WCM\_

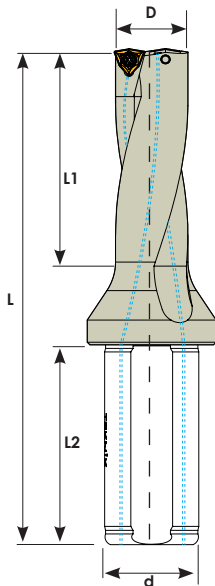
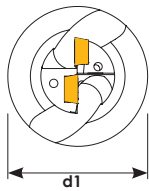

Order Code	Product Code	Dimensions (mm)								Insert	Price
		D	d	d1	L	L1	L2				
U143	16 D3 WCM_03	16	25	34	124	48	56	0,307		114 €	
U143-1	16,5 D3 WCM_03	16,5	25	34	124	48	56	0,304		114 €	
U144	17 D3 WCM_03	17	25	34	127	51	56	0,320	WCM_0302	114 €	
U145	17,5 D3 WCM_03	17,5	25	34	127	51	56	0,336	KRLY	114 €	
U146	18 D3 WCM_03	18	25	34	131	54	56	0,332		114 €	
U147	18,5 D3 WCM_03	18,5	25	34	131	54	56	0,348		114 €	
U148	19 D3 WCM_03	19	25	34	134	57	56	0,338		114 €	
U149	19,5 D3 WCM_03	19,5	25	34	134	57	56	0,340		114 €	
U150	20 D3 WCM_04	20	25	34	139	60	56	0,344		118 €	
U151	20,5 D3 WCM_04	20,5	25	34	139	60	56	0,360		118 €	
U152	21 D3 WCM_04	21	25	34	142	63	56	0,376	WCM_0402	118 €	
U153	21,5 D3 WCM_04	21,5	25	34	142	63	56	0,281	KRLY	118 €	
U154	22 D3 WCM_04	22	25	34	145	66	56	0,385		118 €	
U155	22,5 D3 WCM_04	22,5	25	34	145	66	56	0,394		118 €	
U156	23 D3 WCM_04	23	25	34	150	69	56	0,400		118 €	
U157	23,5 D3 WCM_04	23,5	25	34	150	69	56	0,413		118 €	
U158	24 D3 WCM_05	24	25	34	154	72	56	0,446		123 €	
U159	24,5 D3 WCM_05	24,5	25	34	154	72	56	0,453		123 €	
U160	25 D3 WCM_05	25	25	34	158	75	56	0,467	WCM_0503	123 €	
U161	25,5 D3 WCM_05	25,5	25	34	158	75	56	0,490	KRLY	123 €	
U162	26 D3 WCM_05	26	25	34	161	78	56	0,494		123 €	
U163	26,5 D3 WCM_05	26,5	25	34	161	78	56	0,497		123 €	
U164	27 D3 WCM_05	27	25	34	164	81	56	0,512		123 €	
U165	27,5 D3 WCM_05	27,5	25	34	164	81	56	0,520		123 €	
U166	28 D3 WCM_05	28	25	39	168	84	56	0,576		123 €	
U167	28,5 D3 WCM_05	28,5	25	39	168	84	56	0,584		123 €	
U168	29 D3 WCM_05	29	25	39	171	87	56	0,617		123 €	
U169	29,5 D3 WCM_05	29,5	25	39	171	87	56	0,610		123 €	

Code			
U143-U157	TC060 M2,5x5,5	T8	
U158-U169	TC065 M3x7 M3,5x9		

Compatible with KRLY insert. / Kompatibel für KRLY WP

D3 WCM\_

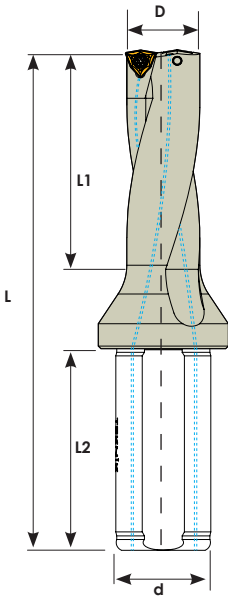
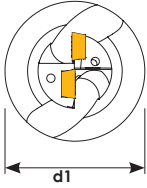

Order Code	Product Code	Dimensions (mm)								Insert	Price
		D	d	d1	L	L1	L2				
U170	30 D3 WCM_06	30	32	44	181	90	58	0,847		128 €	
U171	30,5 D3 W_M_06	30,5	32	44	181	90	58	0,844		128 €	
U172	31 D3 WCM_06	31	32	44	185	93	58	0,872	WCM_06T3	128 €	
U174	32 D3 WCM_06	32	32	44	188	96	58	0,921	KRLY	128 €	
U176	33 D3 WCM_06	33	32	44	192	99	58	0,973		128 €	
U178	34 D3 WCM_06	34	32	44	195	102	58	1,037		128 €	
U179	35 D3 WCM_06	35	32	44	199	105	58	1,082		131 €	
U180	36 D3 WCM_06	36	32	44	203	108	58	1,092		131 €	
U181	37 D3 WCM_06	37	32	44	207	111	58	1,141		131 €	
U182	38 D3 WCM_06	38	32	44	211	114	58	1,188		131 €	
U183	39 D3 WCM_06	39	32	44	214	117	58	1,244		131 €	
U184	40 D3 WCM_06	40	32	44	218	120	58	1,295		142 €	
U186	41 D3 WCM_06	41	32	49	232	123	58	1,465		142 €	
U188	42 D3 WCM_06	42	32	49	235	126	58	1,646		142 €	
U190	43 D3 WCM_06	43	32	54	239	129	58	1,726		142 €	
U192	44 D3 WCM_06	44	32	54	242	132	58	1,916		142 €	
U194	45 D3 WCM_06	45	40	59	247	135	68	2,238		142 €	
U196	46 D3 WCM_08	46	40	59	251	138	68	2,276		157 €	
U198	47 D3 WCM_08	47	40	59	254	141	68	1,919		157 €	
U200	48 D3 WCM_08	48	40	59	258	144	68	2,486		157 €	
U201	49 D3 WCM_08	49	40	59	261	147	68	5,562		175 €	
U202	50 D3 WCM_08	50	40	59	265	150	68	2,725	WCM_0804	175 €	
U203	51 D3 WCM_08	51	40	59	268	153	68	2,537	KRLY	196 €	
U205	52 D3 WCM_08	52	40	59	271	156	68	2,655		196 €	
U207	53 D3 WCM_08	53	40	59	274	159	68	2,740		223 €	
U209	54 D3 WCM_08	54	40	59	277	162	68	3,210		223 €	
U211	55 D3 WCM_08	55	40	59	280	165	68	3,237		231 €	

Code			
U170-U194	TC067 M3,5x8,5	T15	
U196-U211	TC074 M4x10		

Compatible with KRLY insert. / Kompatible für KRLY WP

D4 WCM\_

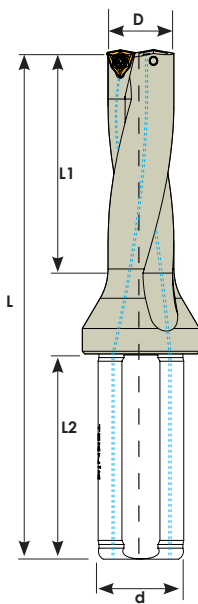
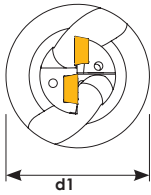
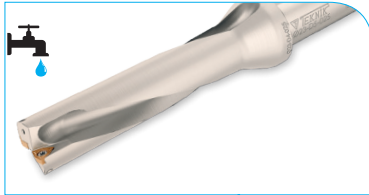

Order Code	Product Code	Dimensions (mm)							Insert	Price
		D	d	d1	L	L1	L2	kg		
U600	16 D4 WCM_03	16	25	34	140	64	56	0,324		155 €
U602	17 D4 WCM_03	17	25	34	144	68	56	0,328	WCM_0302	155 €
U604	18 D4 WCM_03	18	25	34	149	72	56	0,355	KRLY	155 €
U606	19 D4 WCM_03	19	25	34	153	76	56	0,357		155 €
U608	20 D4 WCM_04	20	25	34	159	80	56	0,383	WCM_0402	175 €
U610	21 D4 WCM_04	21	25	34	163	84	56	0,411	KRLY	175 €
U612	22 D4 WCM_04	22	25	34	167	88	56	0,430		175 €
U614	23 D4 WCM_04	23	25	34	173	92	56	0,464		175 €
U616	24 D4 WCM_05	24	25	34	178	96	56	0,425		182 €
U618	25 D4 WCM_05	25	25	34	183	100	56	0,526		182 €
U620	26 D4 WCM_05	26	25	34	187	104	56	0,542	WCM_0503	182 €
U622	27 D4 WCM_05	27	25	34	191	108	56	0,580	KRLY	182 €
U624	28 D4 WCM_05	28	25	39	196	112	56	0,662		182 €
U626	29 D4 WCM_05	29	25	39	200	116	56	0,680		182 €
U628	30 D4 WCM_06	30	32	44	211	120	58	0,912		187 €
U631	31 D4 WCM_06	31	32	44	216	124	58	0,981		187 €
U632	32 D4 WCM_06	32	32	44	220	128	58	1,046		187 €
U633	33 D4 WCM_06	33	32	44	225	132	58	1,102		187 €
U634	34 D4 WCM_06	34	32	44	229	136	58	1,111	WCM_06T3	193 €
U635	35 D4 WCM_06	35	32	44	234	140	58	1,187	KRLY	193 €
U636	36 D4 WCM_06	36	32	44	239	144	58	1,172		193 €
U637	37 D4 WCM_06	37	32	44	244	148	58	1,260		193 €
U638	38 D4 WCM_06	38	32	44	249	152	58	1,430		198 €
U639	39 D4 WCM_06	39	32	44	253	156	58	1,380		198 €
U640	40 D4 WCM_06	40	32	44	258	160	58	1,460		198 €

Code	TC060 M2,5x5,5	T8	
U600-U614	TC060 M2,5x5,5	T8	
U616-U626	TC065 M3x7		
U628-640	TC067 M3,5x8,5	T15	

Compatible with KRLY insert. / Kompatibel für KRLY WP

D5 WCM\_

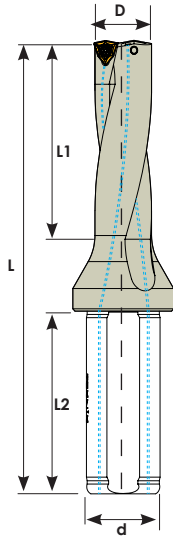
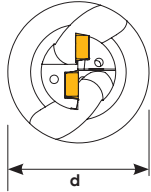
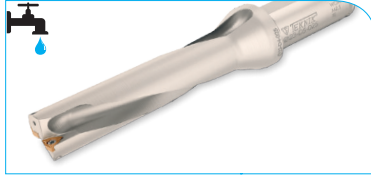

Order Code	Product Code	Dimensions (mm)							Insert	Price
		D	d	d1	L	L1	L2			
U776	16 D5 WCM_03	16	25	34	156	80	56	0,378		163 €
U777	17 D5 WCM_03	17	25	34	161	85	56	0,468	WCM_0302	163 €
U778	18 D5 WCM_03	18	25	34	167	90	56	0,471	KRLY	163 €
U779	19 D5 WCM_03	19	25	34	172	95	56	0,397		163 €
U780	20 D5 WCM_04	20	25	34	179	100	56	0,421		182 €
U781	21 D5 WCM_04	21	25	34	184	105	56	0,451	WCM_0402	182 €
U782	22 D5 WCM_04	22	25	34	190	110	56	0,470	KRLY	182 €
U783	23 D5 WCM_04	23	25	34	196	115	56	0,504		182 €
U784	24 D5 WCM_05	24	25	34	202	120	56	0,465		190 €
U785	25 D5 WCM_05	25	25	34	208	125	56	0,678	WCM_0503	190 €
U786	26 D5 WCM_05	26	25	34	213	130	56	0,620	KRLY	190 €
U787	27 D5 WCM_05	27	25	34	218	135	56	0,620		190 €
U788	28 D5 WCM_05	28	25	39	224	140	56	0,742		190 €
U789	29 D5 WCM_05	29	25	39	229	145	56	0,760		190 €
U790	30 D5 WCM_06	30	32	44	241	150	58	0,992		198 €
U791	31 D5 WCM_06	31	32	44	246	155	58	1,061		198 €
U792	32 D5 WCM_06	32	32	44	252	160	58	1,126	WCM_06T3	198 €
U793	33 D5 WCM_06	33	32	44	258	165	58	1,182	KRLY	198 €
U794	34 D5 WCM_06	34	32	44	263	170	58	1,191		207 €
U795	35 D5 WCM_06	35	32	44	269	175	58	1,227		207 €
U796	36 D5 WCM_06	36	32	44	275	180	58	1,172		207 €
U797	37 D5 WCM_06	37	32	44	281	185	58	1,300		207 €
U798	38 D5 WCM_06	38	32	44	287	190	58	1,480		215 €
U799	39 D5 WCM_06	39	32	44	292	195	58	1,520		215 €
U800	40 D5 WCM_06	40	32	44	298	200	58	1,490		215 €



Code		
U776-U783	TC060 M2,5x5,5	T8
U784-U789	TC065 M3x7 M3,5x9	T15
U790-U800	TC067 M3,5x8,5	T15

Compatible with KRLY insert. / Kompatibel für KRLY WP

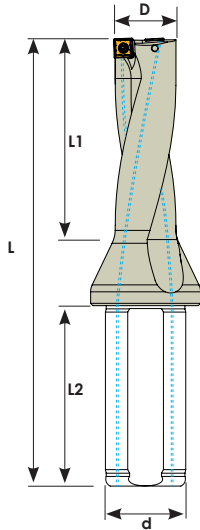
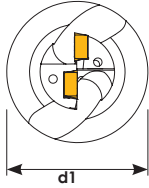
D2 SPMG



Order Code	Product Code	Dimensions (mm)							Insert	Price
		D	d	d1	L	L1	L2	kg		
U913	13 D2 SPMG 05	13	20	25	94	26	50	0,145	SPMG 0502	103 €
U914	14 D2 SPMG 05	14	20	25	96	28	50	0,152	TGTC YG-1	103 €
U915	15 D2 SPMG 05	15	20	25	99	30	50	0,157		103 €
U916	16 D2 SPMG 06	16	25	34	108	32	56	0,275		103 €
U917	17 D2 SPMG 06	17	25	34	110	34	56	0,291		103 €
U918	18 D2 SPMG 06	18	25	34	113	36	56	0,302	SPMG 0602	103 €
U919	19 D2 SPMG 06	19	25	34	115	38	56	0,329	TGTC YG-1	103 €
U920	20 D2 SPMG 06	20	25	34	119	40	56	0,334		113 €
U921	21 D2 SPMG 06	21	25	34	121	42	56	0,338		113 €
U922	22 D2 SPMG 07	22	25	34	123	44	56	0,340		113 €
U923	23 D2 SPMG 07	23	25	34	127	46	56	0,354	SPMG 07T3	113 €
U924	24 D2 SPMG 07	24	25	34	130	48	56	0,382	TGTC YG-1	117 €
U925	25 D2 SPMG 07	25	25	34	133	50	56	0,450		117 €
U926	26 D2 SPMG 07	26	25	34	135	52	56	0,423		117 €
U927	27 D2 SPMG 07	27	25	34	137	54	56	0,435		117 €
U928	28 D2 SPMG 09	28	25	39	140	56	56	0,500		117 €
U929	29 D2 SPMG 09	29	25	39	142	58	56	0,535	SPMG 0904	117 €
U930	30 D2 SPMG 09	30	32	44	151	60	58	0,735	TGTC YG-1	120 €
U931	31 D2 SPMG 09	31	32	44	154	62	58	0,766		120 €
U932	32 D2 SPMG 09	32	32	44	156	64	58	0,781		120 €
U933	33 D2 SPMG 09	33	32	44	159	66	58	0,815		120 €
U934	34 D2 SPMG 11	34	32	44	161	68	58	0,784		120 €
U935	35 D2 SPMG 11	35	32	44	164	70	58	0,845	SPMG 1104	124 €
U936	36 D2 SPMG 11	36	32	44	167	72	58	0,893	TGTC YG-1	124 €
U937	37 D2 SPMG 11	37	32	44	170	74	58	0,931		124 €
U938	38 D2 SPMG 11	38	32	44	173	76	58	0,992		124 €
U939	39 D2 SPMG 11	39	32	44	175	78	58	1,007		124 €
U940	40 D2 SPMG 11	40	32	44	178	80	58	1,020		124 €

Code		
U913-U915	TC058 M2x4,2	T6
U916-U921	TC059 M2,2x5	T7
U922-U927	TC063 M2,5x7	T8
U928-U933	TC067 M3,5x8,5	T15
U934-U940	TC074 M4x10	

Compatible with TGTC-YG-1 insert. / Kompatibel für TGTC-YG-1 WP

D3 SPMG

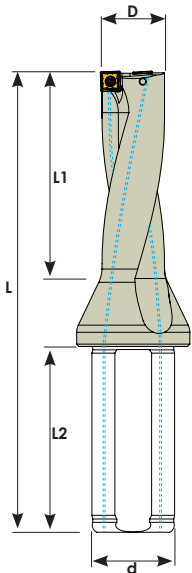
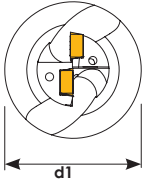
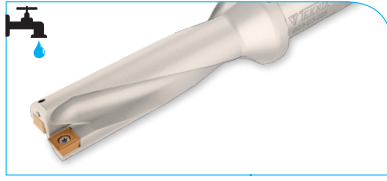

Order Code	Product Code	Dimensions (mm)								Insert	Price
		D	d	d1	L	L1	L2				
U812	12,5 D3 SPMG 05	12,5	20	12	106	38	50	0,158		114 €	
U813	13 D3 SPMG 05	13	20	25	107	39	50	0,164	SPMG 0502	114 €	
U813-1	13,5 D3 SPMG 05	13,5	20	25	107	39	50	0,167	TGTC	114 €	
U814	14 D3 SPMG 05	14	20	25	110	42	50	0,170	YG-1	114 €	
U814-1	14,5 D3 SPMG 05	14,5	20	25	110	42	50	0,170		114 €	
U815	15 D3 SPMG 05	15	20	25	114	45	50	0,175		114 €	
U815-1	15,5 D3 SPMG 05	15,5	20	25	114	45	50	0,175		114 €	
U816	16 D3 SPMG 06	16	25	34	124	48	56	0,302		114 €	
U816-1	16,5 D3 SPMG 06	16,5	25	34	124	48	56	0,302		114 €	
U817	17 D3 SPMG 06	17	25	34	127	51	56	0,318		114 €	
U817-1	17,5 D3 SPMG 06	17,5	25	34	127	51	56	0,318		114 €	
U818	18 D3 SPMG 06	18	25	34	131	54	56	0,327	SPMG 0602	114 €	
U818-1	18,5 D3 SPMG 06	18,5	25	34	131	54	56	0,327	TGTC	114 €	
U819	19 D3 SPMG 06	19	25	34	134	57	56	0,330	YG-1	114 €	
U819-1	19,5 D3 SPMG 06	19,5	25	34	134	57	56	0,330		114 €	
U820	20 D3 SPMG 06	20	25	34	139	60	56	0,347		118 €	
U820-1	20,5 D3 SPMG 06	20,5	25	34	139	60	56	0,350		118 €	
U821	21 D3 SPMG 06	21	25	34	142	63	56	0,377		118 €	
U821-1	21,5 D3 SPMG 06	21,5	25	34	142	63	56	0,377		118 €	
U822	22 D3 SPMG 07	22	25	34	145	66	56	0,375		118 €	
U822-1	22,5 D3 SPMG 07	22,5	25	34	145	66	56	0,375		118 €	
U823	23 D3 SPMG 07	23	25	34	150	69	56	0,407		118 €	
U823-1	23,5 D3 SPMG 07	23,5	25	34	150	69	56	0,412		118 €	
U824	24 D3 SPMG 07	24	25	34	154	72	56	0,446	SPMG 07T3	123 €	
U824-1	24,5 D3 SPMG 07	24,5	25	34	154	72	56	0,452	TGTC	123 €	
U825	25 D3 SPMG 07	25	25	34	158	75	56	0,460	YG-1	123 €	
U825-1	25,5 D3 SPMG 07	25,5	25	34	158	75	56	0,467		123 €	
U826	26 D3 SPMG 07	26	25	34	161	78	56	0,481		123 €	
U826-1	26,5 D3 SPMG 07	26,5	25	34	161	78	56	0,487		123 €	
U827	27 D3 SPMG 07	27	25	34	164	81	56	0,504		123 €	
U827-1	27,5 D3 SPMG 07	27,5	25	34	164	81	56	0,511		123 €	
U828	28 D3 SPMG 09	28	25	39	168	84	56	0,562		123 €	
U828-1	28,5 D3 SPMG 09	28,5	25	39	168	84	56	0,572		123 €	
U829	29 D3 SPMG 09	29	25	39	171	87	56	0,580	SPMG 0904	123 €	
U829-1	29,5 D3 SPMG 09	29,5	25	39	171	87	56	0,585	TGTC	123 €	
U830	30 D3 SPMG 09	30	32	44	181	90	58	0,823	YG-1	128 €	
U831	31 D3 SPMG 09	31	32	44	185	93	58	0,884		128 €	
U832	32 D3 SPMG 09	32	32	44	188	96	58	0,923		128 €	
U833	33 D3 SPMG 09	33	32	44	192	99	58	0,920		128 €	
U834	34 D3 SPMG 11	34	32	44	195	102	58	0,943		128 €	
U835	35 D3 SPMG 11	35	32	44	199	105	58	0,960	SPMG 1104	131 €	
U836	36 D3 SPMG 11	36	32	44	203	108	58	1,043	TGTC	131 €	
U837	37 D3 SPMG 11	37	32	44	207	111	58	1,057	YG-1	131 €	
U838	38 D3 SPMG 11	38	32	44	211	114	58	1,062		131 €	
U839	39 D3 SPMG 11	39	32	44	214	117	58	1,155		131 €	
U840	40 D3 SPMG 11	40	32	44	218	120	58	1,238		131 €	

Code		
U812-U815-1	TC058 M2x4,2	T6
U816-U821-1	TC059 M2,2x5	T7
U822-U827-1	TC063 M2,5x7	T8
U828-U833	TC067 M3,5x8,5	T15
U834-U840	TC074 M4x10	

Compatible with TGTC-YG-1 insert. / Kompatibel für TGTC-YG-1 WP

**D4 SPMG**

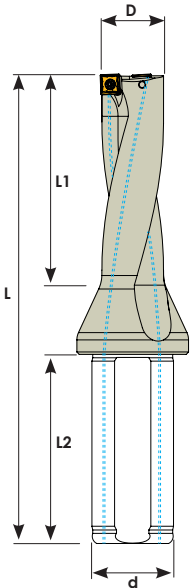
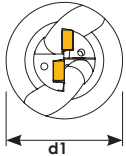

Order Code	Product Code	Dimensions (mm)								Insert	Price
		D	d	d1	L	L1	L2				
U713	13 D4 SPMG 05	13	20	25	120	52	50	0,170	SPMG 0502	144 €	
U714	14 D4 SPMG 05	14	20	25	124	56	50	0,180	TGTC	144 €	
U715	15 D4 SPMG 05	15	20	25	129	60	50	0,190	YG-1	144 €	
U716	16 D4 SPMG 06	16	25	34	140	64	56	0,330		155 €	
U717	17 D4 SPMG 06	17	25	34	144	68	56	0,333		155 €	
U718	18 D4 SPMG 06	18	25	34	149	72	56	0,350	SPMG 0602	155 €	
U719	19 D4 SPMG 06	19	25	34	153	76	56	0,357	TGTC	155 €	
U720	20 D4 SPMG 06	20	25	34	159	80	56	0,383	YG-1	175 €	
U721	21 D4 SPMG 06	21	25	34	163	84	56	0,387		175 €	
U722	22 D4 SPMG 07	22	25	34	167	88	56	0,417		175 €	
U723	23 D4 SPMG 07	23	25	34	173	92	56	0,448	SPMG 07T3	175 €	
U724	24 D4 SPMG 07	24	25	34	178	96	56	0,460	TGTC	182 €	
U725	25 D4 SPMG 07	25	25	34	183	100	56	0,505	YG-1	182 €	
U726	26 D4 SPMG 07	26	25	34	187	104	56	0,539		182 €	
U727	27 D4 SPMG 07	27	25	34	191	108	56	0,561		182 €	
U728	28 D4 SPMG 09	28	25	39	196	112	56	0,642		182 €	
U729	29 D4 SPMG 09	29	25	39	200	116	56	0,646	SPMG 0904	182 €	
U730	30 D4 SPMG 09	30	32	44	211	120	58	0,930	TGTC	187 €	
U731	31 D4 SPMG 09	31	32	44	216	124	58	0,974	YG-1	187 €	
U732	32 D4 SPMG 09	32	32	44	220	128	58	1,014		187 €	
U733	33 D4 SPMG 09	33	32	44	225	132	58	1,050		187 €	
U734	34 D4 SPMG 11	34	32	44	229	136	58	1,040		193 €	
U735	35 D4 SPMG 11	35	32	44	234	140	58	1,155	SPMG 1104	193 €	
U736	36 D4 SPMG 11	36	32	44	239	144	58	1,185	TGTC	193 €	
U737	37 D4 SPMG 11	37	32	44	244	148	58	1,232	YG-1	193 €	
U738	38 D4 SPMG 11	38	32	44	249	152	58	1,320		198 €	
U739	39 D4 SPMG 11	39	32	44	253	156	58	1,356		198 €	
U740	40 D4 SPMG 11	40	32	44	258	160	58	1,421		198 €	

Code		
U713-U715	TC058 M2x4,2	T6
U716-U721	TC059 M2,2x5	T7
U722-U727	TC063 M2,5x7	T8
U728-U733	TC067 M3,5x8,5	T15
U734-U740	TC074 M4x10	

Compatible with TGTC insert. / Kompatibel für TGTC WP

**D3 SPMT**

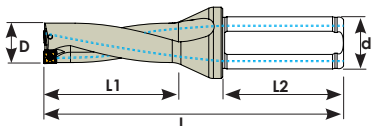

Order Code	Product Code	Dimensions (mm)							Insert	Price
		D	d	d1	L	L1	L2			
U004	13 D3 SPMT 05	13	20	25	107	39	50	0,154	SPMT 0502	114 €
U006	14 D3 SPMT 05	14	20	25	110	42	50	0,158	KRLY.	114 €
U008	15 D3 SPMT 05	15	20	25	114	45	50	0,168		114 €
U010	16 D3 SPMT 06	16	25	34	124	48	56	0,308		114 €
U012	17 D3 SPMT 06	17	25	34	127	51	56	0,313	SPMT 0602	114 €
U014	18 D3 SPMT 06	18	25	34	131	54	56	0,327	KRLY.	114 €
U016	19 D3 SPMT 06	19	25	34	134	57	56	0,350		114 €
U018	20 D3 SPMT 07	20	25	34	139	60	56	0,353	SPMT 0702	114 €
U020	21 D3 SPMT 07	21	25	34	142	63	56	0,395	KRLY.	118 €

Code		
U004-U008	TC058 M2x4,2	T6
U010-U016	TC059 M2,2x5	T7
U018-U022	TC063 M2,5x7	T8

Compatible with KRLY insert. / Kompatibel für KRLY WP

### D3 SOMT

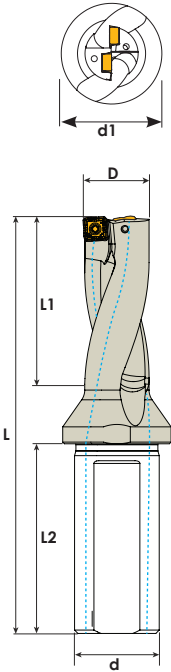

Order Code	Product Code	Dimensions (mm)							Insert	Price
		D	d	d1	L	L1	L2			
U300	13 D3 SOMT 05	13	20	25	111	39	50	0,157		114 €
U302	14 D3 SOMT 05	14	20	25	114	42	50	0,165	SOMT 0502	114 €
U303	14,5 D3 SOMT 05	14,5	20	25	114	42	50	0,170	TGTC	114 €
U304	15 D3 SOMT 05	15	20	25	117	45	50	0,175		114 €
U305	15,5 D3 SOMT 05	15,5	20	25	117	45	50	0,175		114 €
U306	16 D3 SOMT 05	16	25	34	126	48	56	0,302		114 €
U307	16,5 D3 SOMT 06	16,5	25	34	126	48	56	0,302	SOMT 0602	114 €
U308	17 D3 SOMT 06	17	25	34	129	51	56	0,318	TGTC	114 €
U309	17,5 D3 SOMT 06	17,5	25	34	129	51	56	0,318		114 €
U310	18 D3 SOMT 06	18	25	34	132	54	56	0,327		114 €
U311	18,5 D3 SOMT 06	18,5	25	34	132	54	56	0,327		114 €
U312	19 D3 SOMT 06	19	25	34	135	57	56	0,330		114 €
U313	19,5 D3 SOMT 07	19,5	25	34	135	57	56	0,330	SOMT 07T3	114 €
U314	20 D3 SOMT 07	20	25	34	138	60	56	0,347	TGTC	114 €
U315	20,5 D3 SOMT 07	20,5	25	34	138	60	56	0,350		118 €
U316	21 D3 SOMT 07	21	25	34	141	63	56	0,377		118 €
U318	22 D3 SOMT 08	22	25	34	144	66	56	0,375		118 €
U319	22,5 D3 SOMT 08	22,5	25	34	144	66	56	0,375	SOMT 08T3	118 €
U320	23 D3 SOMT 08	23	25	34	147	69	56	0,407	TGTC	118 €
U321	23,5 D3 SOMT 08	23,5	25	34	147	69	56	0,412		118 €
U322	24 D3 SOMT 08	24	25	34	150	72	56	0,446		123 €
U323	24,5 D3 SOMT 08	24,5	25	34	150	72	56	0,452		123 €
U324	25 D3 SOMT 08	25	25	34	153	75	56	0,460		123 €

Code		
U300-U306	TC058 M2x4,2	T6
U307-U318	TC059 M2,2x5	T7
U319-U324	TC063 M2,5x7	T8

Compatible with TGTC insert. / Kompatibel für TGTC WP

### D4 SOMT

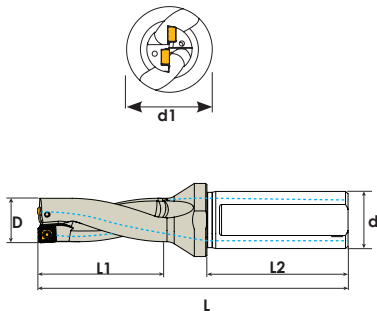

Order Code	Product Code	Dimensions (mm)							Insert	Price
		D	d	d1	L	L1	L2			
U402	14 D4 SOMT 05	14	20	25	128	56	50	0,170	SOMT 0502	144 €
U403	14,5 D4 SOMT 05	14,5	20	25	128	56	50	0,175	TGTC	144 €
U406	16 D4 SOMT 05	16	25	34	142	64	56	0,322		155 €
U408	17 D4 SOMT 06	17	25	34	146	68	56	0,338	SOMT 0602	155 €
U409	17,5 D4 SOMT 06	17,5	25	34	146	68	56	0,348	TGTC	155 €
U410	18 D4 SOMT 06	18	25	34	150	72	56	0,347		155 €
U412	19 D4 SOMT 06	19	25	34	154	76	56	0,350		155 €
U414	20 D4 SOMT 07	20	25	34	158	8	56	0,387	SOMT 07T3	175 €
U416	21 D4 SOMT 07	21	25	34	162	84	56	0,417	TGTC	175 €
U418	22 D4 SOMT 07	22	25	34	166	88	56	0,425		175 €
U420	24 D4 SOMT 08	24	25	34	174	96	56	0,486	SOMT 08T3	182 €
U422	25 D4 SOMT 08	25	25	34	178	100	56	0,498	TGTC	182 €

  

Code		
U402-U406	TC058 M2x4,2	T6
U408-U418	TC059 M2,2x5	T7
U420-U422	TC063 M2,5x7	T8

Compatible with TGTC insert. / Kompatibel für TGTC WP



D2-D3 XCMT-QCMT

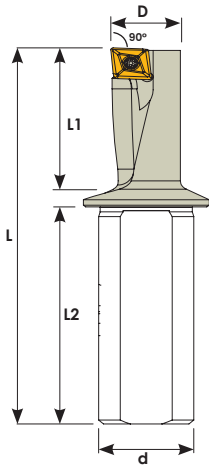
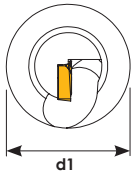
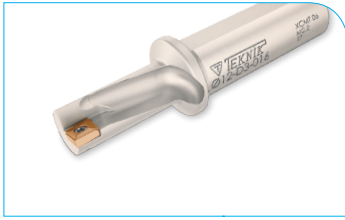

Order Code	Product Code	Dimensions (mm)							Insert	Price
		D	d	d1	L	L1	L2			
U030	10 D2,25 QC-- 050204	10	12	16	74,5	22,5	42	0,062	QC-- 050204 KRLY	84 €
U032	12 D2,25 QC-- 060204	12	16	20	85	27	45	0,100	QC-- 060204 KRLY	84 €
U034	14 D2,25 QC-- 070304	14	16	20	90	31,5	45	0,111	QC-- 070304 KRLY	88 €
U036	16 D2,25 QC-- 080304	16	20	25	100	36	50	0,191	QC-- 080304 KRLY	88 €
U040	20 D2,25 QC-- 10T304	20	25	31	116	45	56	0,330	QC-- 10T304 KRLY	94 €
U042	25 D2,25 QC-- 130404	25	32	39	135	56,5	60	0,600	QC-- 130404 KRLY	102 €
U038	18 D2,25 XC-- 09T304	18	25	31	112	40,5	56	0,356	XCMT 09T304 ISCR	94 €

Code			
U030	TC058 M2x4,2	T6	QC-- 050204
U032	TC059 M2,2x5	T7	QC-- 060204
U034	TC060 M2,5x5,5	T8	QC-- 070304
U036	TC065 M3x7	T8	QC-- 080304
U040	TC067 M3,5x8,5	T15	QC-- 10T304
U042	TC080 M4,5x11	T15	QC-- 130404
U038	TC065 M3x7	T8	XCMT 09T304

Compatible with KRLY insert. / Kompatibel für KRLY WP(QC--)(QX-) - ISCR Uclarına Uygundur.(XCMT) .(XCMT)

Order Code	Product Code	Dimensions (mm)							Insert	Price
		D	d	d1	L	L1	L2			
U08	8 D2 XC-- 040104	8	12	16	68	18	42	0,056	XCMT 0401 TGTC	84 €
U12	10 D3 XC-- 050204	10	16	25	90	30	45	0,109	XCMT 0502	84 €
U14	10,5 D3 XC-- 050204	10,5	16	25	90	31	45	0,111	TGTC	84 €
U18	11,5 D3 XC-- 060204	11,5	16	25	92	35	45	0,113	XCMT 0602	84 €
U20	12 D3 XC-- 060204	12	16	25	94	36	45	0,114	TGTC	84 €

Code			
U08	TC058 M2x4,2	T6	XCMT 040104
U12 - U14	TC058 M2x4,5	T6	XCMT 050204
U18 - U20	TC059 M2,2x5	T7	XCMT 060204

Compatible with TGTC insert. / Kompatibel für TGTC WP

Alüminyum

Order Code	Product Code	Dimensions (mm)							Insert	Price
		D	d	d1	L	L1	L2			
U32	10,5 D3 XC-- 050204	10,5	16	25	90	31	45	0,114	XCGT 050204	84 €
U34	11 D3 XC-- 050204	11	16	25	92	33	45	0,112	TGTC	84 €
U36	11,5 D3 XC-- 060204	11,5	16	25	92	35	45	0,112	XCGT 060204 TGTC	84 €

Code			
U32 - U34	TC058 M2x4,5	T6	XCGT 050204
U36	TC059 M2,2x5	T7	XCGT 060204

Compatible with TGTC insert. / Kompatibel für TGTC WP

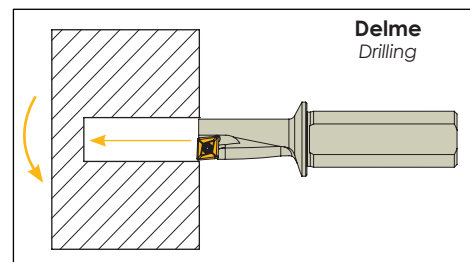
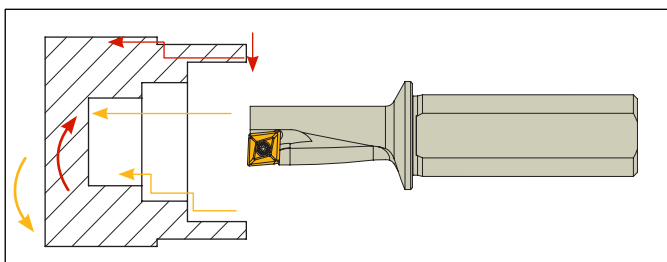

Kalite için **TEKNIK** çözüm  
Technical solution for quality



THE **TEKNIK MAKİNA**®  
**EXCEPTIONAL CUTTING TOOLS**  
COLLECTION

[www.teknikmakinatakim.com](http://www.teknikmakinatakim.com)

## Grooving Holders

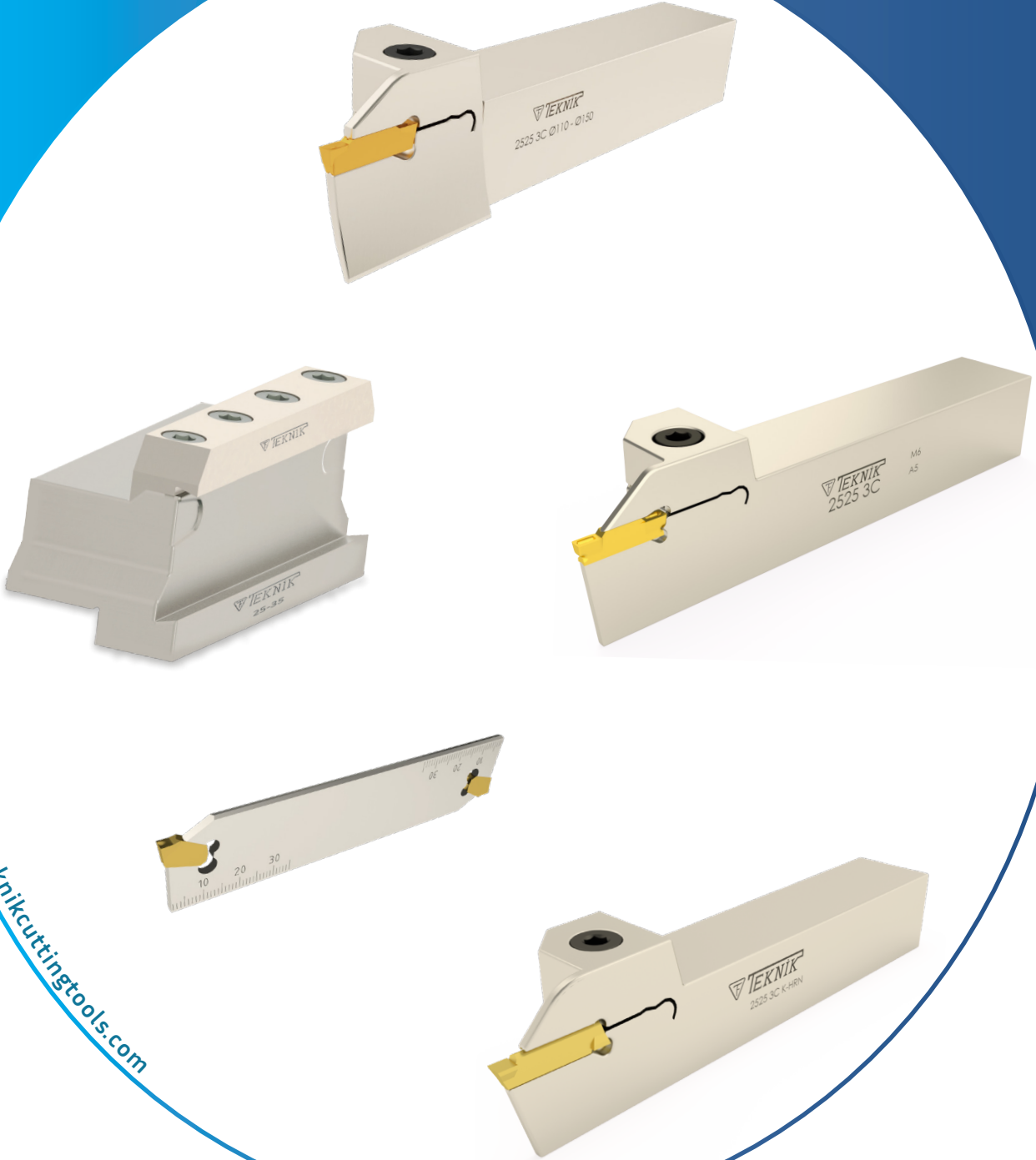

[www.teknikcuttingtools.com](http://www.teknikcuttingtools.com)



Kalite için TEKNİK çözüm  
Technical solution for quality

140-146



**KRLY-R**

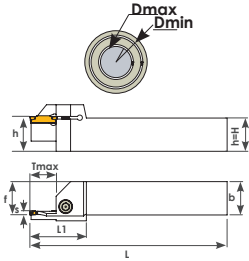
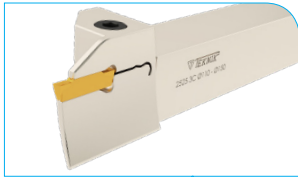

Order Code	Product Code	Dimensions (mm)											Insert	Price
		Dmin	Dmax	S	Tmax	f	b	h	L	L1				
D780	2525 3C-R (50-60)	50	60	3	17	25	25	25	150	40	0,741		75 €	
D782	2525 3C-R (60-80)	60	80	3	17	25	25	25	150	40	0,717	MGM 300	75 €	
D784	2525 3C-R (80-110)	80	110	3	17	25	25	25	150	40	0,720	KRLY.	75 €	
D785	2525 3C-R (110-150)	110	150	3	17	25	25	25	150	40	0,730		75 €	
D786	2525 4C-R (50-60)	50	60	4	20	25	25	25	150	45	0,704		75 €	
D788	2525 4C-R (60-80)	60	80	4	20	25	25	25	150	45	0,712	MGM 400	75 €	
D790	2525 4C-R (80-110)	80	110	4	20	25	25	25	150	45	0,701	KRLY.	75 €	
D791	2525 4C-R (110-150)	110	150	4	20	25	25	25	150	45	0,712		75 €	
D791-1	2525 4C (140-600)	140	600	4	25	25	25	25	150	49	0,667		75 €	
D792	2525 5C-R (50-80)	50	80	5	20	25	25	25	150	45	0,721		75 €	
D796	2525 5C-R (80-110)	80	110	5	20	25	25	25	150	45	0,716	MGM 500	75 €	
D798	2525 5C-R (110-150)	110	150	5	20	25	25	25	150	45	0,718	KRLY.	75 €	
D799-1	2525 5C-R (350-500)	350	500	5	20	25	25	25	150	45	0,713		75 €	
D799-2	2525 5C-R (140-600)	140	600	5	25	25	25	25	150	49	0,664		75 €	

TC134 M6x20

5 Allen



KRLY Ucuna Uygundur.

**KRLY-L**

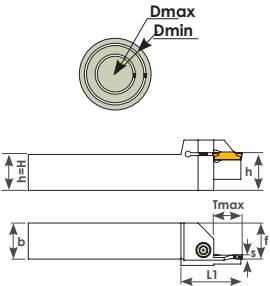

Order Code	Product Code	Dimensions (mm)											Insert	Price
		Dmin	Dmax	S	Tmax	f	b	h	L	L1				
D800	2525 3C-L (50-60)	50	60	3	17	25	25	25	150	40	0,741		75 €	
D802	2525 3C-L (60-80)	60	80	3	17	25	25	25	150	40	0,717	MGM 300	75 €	
D804	2525 3C-L (80-110)	80	110	3	17	25	25	25	150	40	0,720	KRLY	75 €	
D805	2525 3C-L (110-150)	110	150	3	17	25	25	25	150	40	0,730		75 €	
D806	2525 4C-L (50-60)	50	60	4	20	25	25	25	150	45	0,704		75 €	
D808	2525 4C-L (60-80)	60	80	4	20	25	25	25	150	45	0,712	MGM 400	75 €	
D810	2525 4C-L (80-110)	80	110	4	20	25	25	25	150	45	0,700	KRLY	75 €	
D811	2525 4C-L (110-150)	110	150	4	20	25	25	25	150	45	0,712		75 €	
D811-1	2525 4C-L (140-600)	140	600	4	25	25	25	25	150	49	0,667		75 €	
D812	2525 5C-L (50-80)	50	80	5	20	25	25	25	150	45	0,721		75 €	
D816	2525 5C-L (80-110)	80	110	5	20	25	25	25	150	45	0,716		75 €	
D818	2525 5C-L (110-150)	110	150	5	20	25	25	25	150	45	0,718	MGM 500	75 €	
D819	2525 5C-L (140-600)	140	600	5	25	25	25	25	150	49	0,664	KRLY	75 €	
D819-1	2525 5C-L (350-500)	350	500	5	20	25	25	25	150	45	0,713		75 €	

TC134 M6x20

5 Allen



KRLY Ucuna Uygundur.

**MGM/R**

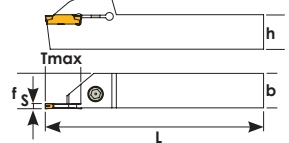
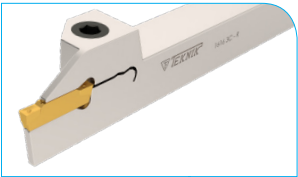

Order Code	Product Code	Dimensions (mm)							Insert	Price
		h	b	S	Tmax	f	L			
D658	1212 2C-R MGM	12	12	2	16	12	125	0,162		51 €
D660	1616 2C-R MGM	16	16	2	16	16	125	0,250	MGM 200	54 €
D662	2020 2C-R MGM	20	20	2	16	20	125	0,404	KRLY	55 €
D664	2525 2C-R MGM	25	25	2	16	25	150	0,726		56 €
D666	3232 2C-R MGM	32	32	2	16	32	170	1,349		65 €
D667	1212 3C-R MGM	12	12	3	18	12	125	0,162		51 €
D668	1616 3C-R MGM	16	16	3	18	16	125	0,268	MGM 300	54 €
D670	2020 3C-R MGM	20	20	3	18	20	125	0,407	KRLY	55 €
D672	2525 3C-R MGM	25	25	3	18	25	150	0,727		56 €
D674	3232 3C-R MGM	32	32	3	18	32	170	1,280		65 €
D675	1616 4C-R MGM	16	16	4	18	16	125	0,273		54 €
D676	2020 4C-R MGM	20	20	4	18	20	125	0,408	MGM 400	55 €
D678	2525 4C-R MGM	25	25	4	18	25	150	0,727	KRLY	56 €
D680	3232 4C-R MGM	32	32	4	20	32	170	1,287		65 €
D682	2020 5C-R MGM	20	20	5	25	20	125	0,391	MGM 500	55 €
D684	2525 5C-R MGM	25	25	5	25	25	150	0,703	KRLY	56 €
D686	3232 5C-R MGM	32	32	5	25	32	170	1,268		65 €
D687	2525 6C-R MGM	25	25	6	27	25	150	0,745	MGM 600 KRLY	56 €

Kod

D658-D660,D667-D668,D675-D676

TC131 M5x16

4 Allen

D662,D670,D675-D676,D682

TC132 M5x20

D664-D666,D672-D674,D378,D680,D684,D687

TC134 M6x20

5 Allen



KRLY Ucuna Uygundur.

**MGM /R**

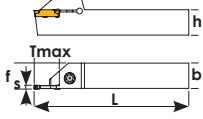
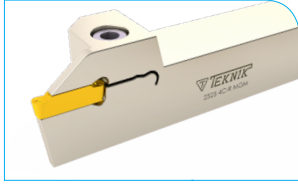

KRLY Ucuna Uygundur.

Order Code	Product Code	Dimensions (mm)							Insert	Price
		h	b	S	Tmax	f	L	kg		
D960	2525 3C-R MGM	25	25	3	25	25	150	0,727	MGM 300	77 €
D963	2525 3C-R MGM	25	25	3	40	25	170	0,722	KRLY	83 €
D961	2525 4C-R MGM	25	25	4	25	25	150	0,727	MGM 400	77 €
D964	2525 4C-R MGM	25	25	4	40	25	170	0,721	KRLY	83 €
D962	2525 5C-R MGM	25	25	5	40	25	170	0,745	MGM 500 KRLY	83 €



**MGM /L**

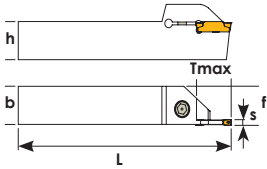
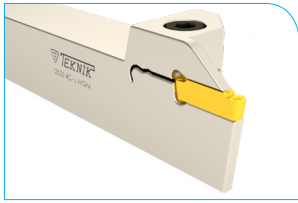

KRLY Ucuna Uygundur.

Order Code	Product Code	Dimensions (mm)							Insert	Price
		h	b	S	Tmax	f	L	kg		
D607	1212 2C-L MGM	12	12	2	16	12	125	0,161	MGM 200	51 €
D608	1616 2C-L MGM	16	16	2	16	16	125	0,250	KRLY	54 €
D610	2020 2C-L MGM	20	20	2	16	20	125	0,404		55 €
D611	2525 2C-L MGM	25	25	2	16	25	150	0,726		56 €
D612	1616 3C-L MGM	16	16	3	18	16	125	0,268	MGM 300	54 €
D614	2020 3C-L MGM	20	20	3	18	20	125	0,407	KRLY	55 €
D615	2525 3C-L MGM	25	25	3	18	25	150	0,750		56 €
D617	2020 4C-L MGM	20	20	4	18	20	125	0,407	MGM 400	55 €
D618	2525 4C-L MGM	25	25	4	18	25	150	0,727	KRLY	56 €
D620	2525 5C-L MGM	25	25	5	25	25	150	0,703	MGM 500 KRLY	56 €
D621	2525 6C-L MGM	25	25	5	27	25	150	0,745	MGM 600 KRLY	56 €

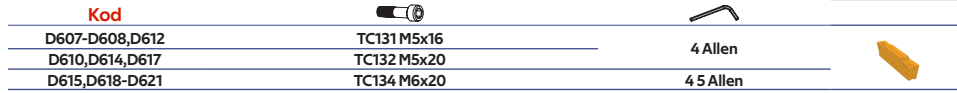

**KGMN /R**

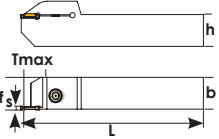
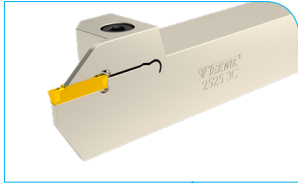

KRLY Ucuna Uygundur.

Order Code	Product Code	Dimensions (mm)							Insert	Price
		h	b	S	Tmax	f	L	kg		
D635	2020 2C-R KGMN	20	20	2	18	20	125	0,412	KGMN 200	55 €
D636	2525 2C-R KGMN	25	25	2	18	25	150	0,726	KRLY	56 €
D637	2020 3C-R KGMN	20	20	3	20	20	125	0,406	KGMN 300	55 €
D638	2525 3C-R KGMN	25	25	3	22	25	150	0,732	KRLY	56 €
D639	2020 4C-R KGMN	20	20	4	20	20	125	0,406	KGMN 400	55 €
D640	2525 4C-R KGMN	25	25	4	22	25	152	0,737	KRLY	56 €



**KGMN**

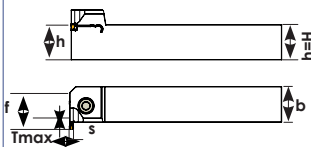
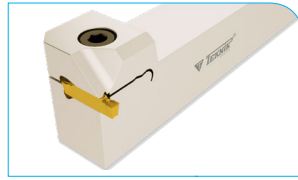

KRLY Ucuna Uygundur.

Order Code	Product Code	Dimensions (mm)							Insert	Price
		h	b	S	Tmax	f	L	kg		
D622	2020 2C KGMN	20	20	2	3,5	23,5	125	0,412	KGMN 200	55 €
D623	2525 2C KGMN	25	25	2	3,5	28,5	150	0,833	KRLY	56 €
D624	2020 3C KGMN	20	20	3	5	25	125	0,468	KGMN 300	55 €
D625	2525 3C KGMN	25	25	3	5	30	150	0,837	KRLY	56 €
D626	2020 4C KGMN	20	20	4	5	25	125	0,463	KGMN 400	55 €
D627	2525 4C KGMN	25	25	4	5	30	150	0,464	KRLY	56 €

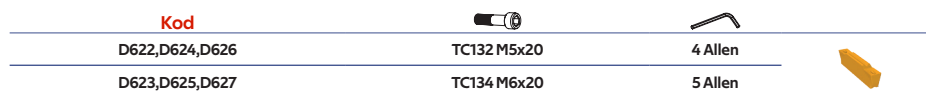

GRP/R

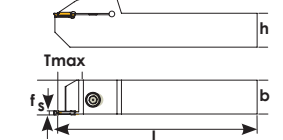
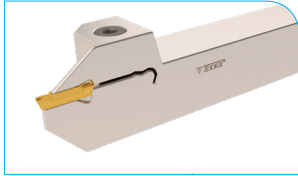

ISCR Ucuna Uygunudur.

Order Code	Product Code	Dimensions (mm)							Insert	Price
		h	b	S	Tmax	f	L	kg		
D773	2020 3C-R GRP	20	20	3	18	20	125	0,409	GRP 3C	55 €
D769	2525 3C-R GRP	25	25	3	18	25	150	0,755	ISCR	56 €
D770	2525 4C-R GRP	25	25	4	20	25	150	0,747	GRP 4C	56 €
D772	3232 4C-R GRP	32	32	4	18	32	170	1,285	ISCR	65 €
D771	2525 5C-R GRP	25	25	5	24	25	150	0,739	GRP 5C	56 €
D774	3232 5C-R GRP	32	32	5	24	32	170	1,264	ISCR	65 €
<b>Kod</b>										
D773		TC132 M5x20			4 Allen					
D770-D774		TC134 M6x20			5 Allen					

ISCR/R

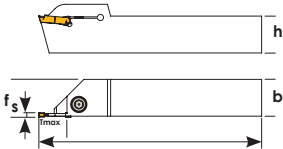
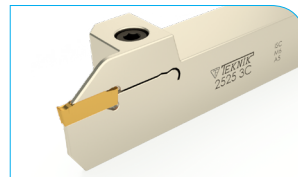

ISCR Ucuna Uygunudur.

Order Code	Product Code	Dimensions (mm)							Insert	Price
		h	b	S	Tmax	f	L	kg		
D750	1212 2C-R DGN	12	12	2	16	12	125	0,158		51 €
D752	1616 2C-R DGN	16	16	2	16	16	125	0,260	DGN 2C	54 €
D754	2020 2C-R DGN	20	20	2	18	20	125	0,398	ISCR	55 €
D756	2525 2C-R DGN	25	25	2	19	25	150	0,712		56 €
D758	1212 3C-R DGN	12	12	3	16	12	125	0,160		51 €
D760	1616 3C-R DGN	16	16	3	19	16	125	0,253	DGN 3C	54 €
D762	2020 3C-R DGN	20	20	3	20	20	125	0,394	ISCR	55 €
D764	2525 3C-R DGN	25	25	3	22	25	150	0,711		56 €
D764-1	2525 3C-R DGN	25	25	3	25	25	150	0,711		56 €
D775	2020 4C-R DGN	20	20	4	20	20	125	0,391	DGN 4C	55 €
D777	2525 4C-R DGN	25	25	4	20	25	150	0,709	ISCR	56 €
<b>Kod</b>										
(D750-D752),(D758-D760)		TC131 M5x16			4 Allen					
D754,D775		TC132 M5x20			5 Allen					
D756,D764,D777		TC134 M6x20								

ISCR/L

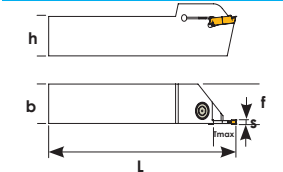
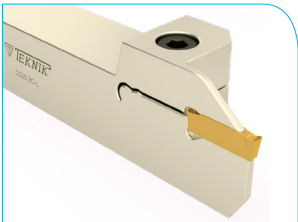

ISCR Ucuna Uygunudur.

Order Code	Product Code	Dimensions (mm)							Insert	Price
		h	b	S	Tmax	f	L	kg		
D726	1212 2C-L DGN	12	12	2	16	12	125	0,158	DGN 2C	51 €
D727	1616 2C-L DGN	16	16	2	16	16	125	0,260	ISCR	54 €
D728	2020 2C-L DGN	20	20	2	18	20	125	0,398		55 €
D729	2525 2C-L DGN	25	25	2	19	25	150	0,712		56 €
D730	1212 3C-L DGN	12	12	3	16	12	125	0,160	DGN 3C	51 €
D731	1616 3C-L DGN	16	16	3	19	16	125	0,253	ISCR	54 €
D732	2020 3C-L DGN	20	20	3	20	20	125	0,394		55 €
D733	2525 3C-L DGN	25	25	3	22	25	150	0,711		56 €
<b>Kod</b>										
D726-D727,D730-D731		TC131 M5x16			4 Allen					
D728,D733		TC132 M5x20								
D728-D729,D732-D733		TC134 M5x20								

ZCC/R ZT-D

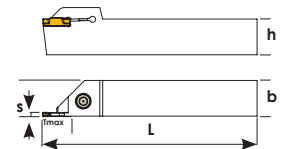
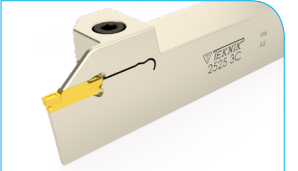

ZCC Ucuna Uygunudur.

Order Code	Product Code	Dimensions (mm)							Insert	Price
		h	b	S	Tmax	f	L	kg		
D027	1616 3C-R ZT-D	16	16	3	18	16	125	0,301	ZT.D 3C	54 €
D028	2020 3C-R ZT-D	20	20	3	18	20	125	0,394	ZCC	55 €
D030	2525 3C-R ZT-D	25	25	3	22	25	150	0,755		56 €
D036	2020 4C-R ZT-D	20	20	4	18	20	125	0,400	ZT.D 4C	55 €
D038	2525 4C-R ZT-D	25	25	4	22	25	150	0,747	ZCC	56 €
D044	2020 5C-R ZT-D	20	20	5	18	20	125	0,391	ZT.D 5C	55 €
D046	2525 5C-R ZT-D	25	25	5	18	25	150	0,734	ZCC	56 €
D049	2525 6C-R ZT-D	25	25	6	18	25	150	0,745	ZT.D 6C	56 €
D051	3232 6C-R ZT-D	32	32	6	20	32	170	1,331	ZCC	65 €
<b>Kod</b>										
D027		TC131 M5x16			4 Allen					
D028,D036,D044		TC132 M5x20			5 Allen					
D030,D038,D046-D051		TC134 M6x20								

**TKT/R TD**

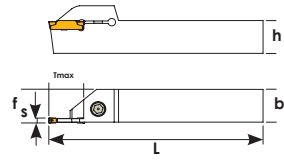

Order Code	Product Code	Dimensions (mm)							Insert	Price
		h	b	S	Tmax	f	L	(kg)		
D714	1212 2C-R TD	12	12	2	16	12	125	0,166	TD 2C	51€
D715	1616 2C-R TD	16	16	2	16	16	125	0,270	TGTC	54€
D716	2020 2C-R TD	20	20	2	16	20	125	0,401		55€
D717	2525 2C-R TD	25	25	2	18	25	150	0,728		56€
D718	1212 3C-R TD	12	12	2	16	12	125	0,160		51€
D719	1616 3C-R TD	16	16	3	18	16	125	0,256	TD 3C	54€
D720	2020 3C-R TD	20	20	3	18	20	125	0,398	TGTC	55€
D721	2525 3C-R TD	25	25	3	18	25	150	0,735		56€
D722	2020 4C-R TD	20	20	4	18	20	125	0,401	TD 4C	55€
D723	2525 4C-R TD	25	25	4	18	25	150	0,735	TGTC	56€

Kod		TC131 M5x16		TC132 M5x20		TC134 M6x20	
D714-D715,D718-D719							
D716,D720,D722							
D717,D721,D723							

TGTC Ucuna Uygundur.

**K.HRN/R S224**

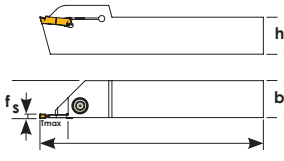
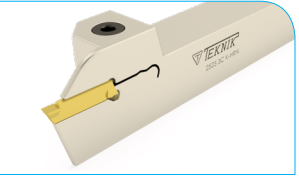

Order Code	Product Code	Dimensions (mm)							Insert	Price
		h	b	S	Tmax	f	L	(kg)		
D700	1616 2C-R S224	16	16	2	18	16	125	0,258	2C S224	54€
D701	2020 2C-R S224	20	20	2	18	20	125	0,406	K.HRN	55€
D702	2525 2C-R S224	25	25	2	18	25	150	0,713		56€
D703	1616 3C-R S224	16	16	3	18	16	100	0,260	3C S224	54€
D704	2020 3C-R S224	20	20	3	18	20	125	0,407	K.HRN	55€
D705	2525 3C-R S224	25	25	3	18	25	150	0,720		56€
D706	2020 4C-R S224	20	20	4	18	20	125	0,401	4C S224	55€
D707	2525 4C-R S224	25	25	4	18	25	150	0,737	K.HRN	56€
D708	2020 5C-R S224	20	20	5	18	20	125	0,401	5C S224	55€
D710	2525 5C-R S224	25	25	5	18	25	150	0,730	K.HRN	56€

Kod		TC131 M5x16		TC132 M5x20		TC134 M6x20	
D700,D703							
D701,D702,D704,D706,D708							
D705,D707,D710							

HRN Ucuna Uygundur.

**B.HRN/R S229**

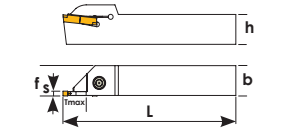
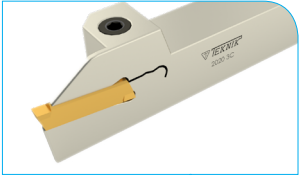

Order Code	Product Code	Dimensions (mm)							Insert	Price
		h	b	S	Tmax	f	L	(kg)		
D688	2020 3C-R S229	20	20	3	22	20	125	0,391	3C S229	55€
D690	2525 3C-R S229	25	25	3	22	25	150	0,700	B.HRN	56€
D692	2020 4C-R S229	20	20	4	22	20	125	0,386	4C S229	55€
D694	2525 4C-R S229	25	25	4	22	25	150	0,705	B.HRN	56€
D696	2020 5C-R S229	20	20	5	22	20	125	0,389	5C S229	55€
D698	2525 5C-R S229	25	25	5	22	25	150	0,709	B.HRN	56€

Kod		TC132 M5x20		TC134 M6x20	
D688-D692,D696					
D690,D694,D698					

HRN Ucuna Uygundur.

**B.HRN/L S229**

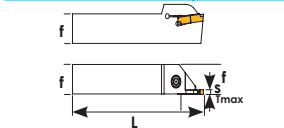

Order Code	Product Code	Dimensions (mm)							Insert	Price
		h	b	S	Tmax	f	L	(kg)		
D711	2525 3C-L S229	25	25	3	22	25	150	0,700	3C S229 B.HRN	56€
D712	2525 4C-L S229	25	25	4	22	25	150	0,705	4C S229 B.HRN	56€
D713	2525 5C-L S229	25	25	5	22	25	150	0,709	5C S229 B.HRN	56€

Kod		TC134 M6x20	

HRN Ucuna Uygundur.

### SDV 123/R

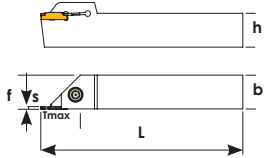
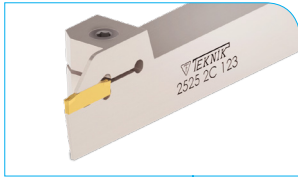

Order Code	Product Code	Dimensions (mm)							Insert	Price	
		h	b	S	Tmax	f	L				
D900	2020 2C-123 SDV-R	20	20	2	18	20	125	0,400	123 2C	55 €	
D902	2525 2C-123 SDV-R	25	25	2	18	25	150	0,732	SDV	56 €	
D904	2020 3C-123 SDV-R	20	20	3	19	20	125	0,397	123 3C	55 €	
D906	2525 3C-123 SDV-R	25	25	3	20	25	150	0,713	SDV	56 €	
D908	2020 4C-123 SDV-R	20	20	4	18	20	125	0,415	123 4C	55 €	
D910	2525 4C-123 SDV-R	25	25	4	18	25	150	0,724	SDV	56 €	
D912	2525 5C-123 SDV-R	25	25	5	18	25	150	0,725	123 SDV 5C	56 €	
<b>Kod</b>											
D900,D904,D908		TC132 M5x20		4 Allen							
D902,D906,D910-D912		TC134 M6x20		5 Allen							

SNDVK Ucuna Uygundur.

### SDV 123/L

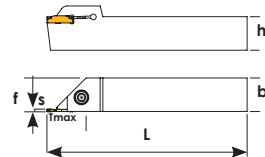

Order Code	Product Code	Dimensions (mm)							Insert	Price	
		h	b	S	Tmax	f	L				
D873	2020 2C-123 SDV-L	20	20	2	18	20	125	0,400	123 2C	55 €	
D874	2525 2C-123 SDV-L	25	25	2	18	25	150	0,732	SDV	56 €	
D875	2020 3C-123 SDV-L	20	20	3	19	20	125	0,397	123 3C	55 €	
D876	2525 3C-123 SDV-L	25	25	3	20	25	150	0,713	SDV	56 €	
D877	2020 4C-123 SDV-L	20	20	4	18	20	125	0,415	123 4C	55 €	
D878	2525 4C-123 SDV-L	25	25	4	18	25	150	0,724	SDV	56 €	
D879	2525 5C-123 SDV-L	25	25	5	18	25	150	0,725	123 5C SDV	56 €	
<b>Kod</b>											
D873,D875,D877		TC132 M5x20		4 Allen							
D874,D876,D878-D912		TC134 M6x20		5 Allen							

SNDVK Ucuna Uygundur.

### DGM 2-3

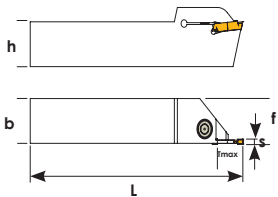
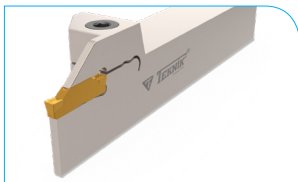

Order Code	Product Code	Dimensions (mm)							Insert	Price	
		h	b	S	Tmax	f	L				
D842	1212 2C-DGM 2	12	12	2	16	12	125	0,166		51 €	
D843	1616 2C-DGM 2	16	16	2	17	16	125	0,267	DGM 2C	54 €	
D844	2020 2C-DGM 2	20	20	2	17	20	125	0,403	TNGLY	55 €	
D845	2525 2C-DGM 2	25	25	2	17	25	150	0,739		56 €	
D847	1212 3C-DGM 3	12	12	3	16	12	125	0,168		51 €	
D848	1616 3C-DGM 3	16	16	3	17	16	125	0,263	DGM 3C	54 €	
D849	2020 3C-DGM 3	20	20	3	20	20	125	0,395	TNGLY	55 €	
D850	2525 3C-DGM 3	25	25	3	20	25	150	0,740		56 €	
<b>Kod</b>											
D842,D843		TC131 M5x16		4 Allen							
D844,D847-D849		TC132 M5x20		5 Allen							
D845-D850		TC134 M6x20									

TNGLY Ucuna Uygundur.



**GX16-GX24**

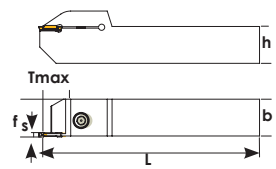

Order Code	Product Code	Dimensions (mm)							Insert	Price
		h	b	S	Tmax	f	L			
D858	2020 2C GX16	20	20	2	18	20	125	0,267	GX 16 2C WLTR	55 €
D859	2525 2C GX16	25	25	2	18	25	150	0,403	GX 16 2C WLTR	56 €
D860	2020 3C GX16	20	20	3	20	20	125	0,395	GX 16 3C WLTR	55 €
D861	2525 3C GX16	25	25	3	22	25	150	0,740	GX 16 3C WLTR	56 €
D864	2020 2C GX24	20	20	2	18	20	125	0,403	GX 24 2C WLTR	55 €
D865	2525 2C GX24	25	25	2	18	25	150	0,739	GX 24 2C WLTR	56 €
D866	2020 3C GX24	20	20	3	20	20	125	0,395	GX 24 3C WLTR	55 €
D867	2525 3C GX24	25	25	3	22	25	150	0,740	GX 24 3C WLTR	56 €
<b>Kod</b>										
D858,D860,D864, D866		TC132 M5x20		4 Allen						
D859,D861,D865-D867		TC134 M6x20		5 Allen						

WLTR Ucuna Uygundur.

**External Threading Toolholders Sliding Automatic Lathes**

**MGMN**

**NEW PRODUCT**

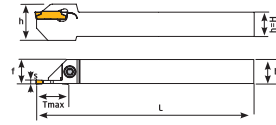

Sipariş Kodu	Ürün Kodu	Ölçüler (mm)							Uç	Fiyat
		h	b	S	Tmax	f	L			
D010	1212 2C MGMN 200	12	12	2	12	12,2	125	0,166	MGMN 200 KRKY	
D011	1616 2C MGMN 200	16	16	2	16	16,2	125	0,267	MGMN 200 KRKY	
D013	1212 3C MGMN 300	12	12	3	12	12,3	125	0,166	MGMN 300 KRKY	
D014	1616 3C MGMN 300	16	16	3	16	16,3	125	0,267	MGMN 300 KRKY	
<b>Kod</b>										
D010-D014		TC074 M4x10		T15						

KRKY Ucuna Uygundur.

**External Threading Toolholders Sliding Automatic Lathes**

**KGMN**

**NEW PRODUCT**

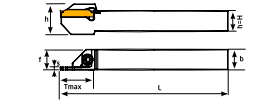

Sipariş Kodu	Ürün Kodu	Ölçüler (mm)							Uç	Fiyat
		h	b	S	Tmax	f	L			
D016	1212 2C KGMN 200	12	12	2	12	12,2	125	0,166	KGMN 200 KRKY	
D017	1616 2C KGMN 200	16	16	2	16	16,2	125	0,267	KGMN 200 KRKY	
<b>Kod</b>										
D016-D017		TC074 M4x10		T15						

KRKY Ucuna Uygundur.

**External Threading Toolholders Sliding Automatic Lathes**

**DGN**

**NEW PRODUCT**

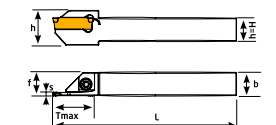

Sipariş Kodu	Ürün Kodu	Ölçüler (mm)							Uç	Fiyat
		h	b	S	Tmax	f	L			
D019	1212 2C DGN	12	12	2	12	12,2	125	0,166	DGN 2C ISCR	
D020	1616 2C DGN	16	16	2	16	16,2	125	0,267	DGN 2C ISCR	
D021	1212 3C-DGN	12	12	3	12	12,3	125	0,166	DGN 3C ISCR	
D022	1616 3C-DGN	16	16	3	16	16,3	125	0,267	DGN 3C ISCR	
<b>Kod</b>										
D842-D845		TC074 M4x10		T15						

ISCR Ucuna Uygundur.

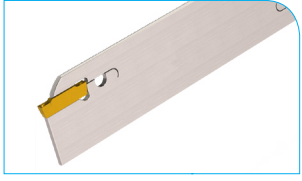
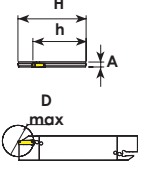
MGMN	Order Code	Product Code	Dimensions (mm)					Insert	Price
			H	h	A	L	D max		
	KL29	32-2	32	25	2	150	36	MGMN 200 KRLY	57 €
	KL30	32-3	32	25	2,45	150	36	MGMN 300 KRLY	57 €
	KL32	32-4	32	25	3,45	150	36	MGMN 400 KRLY	57 €

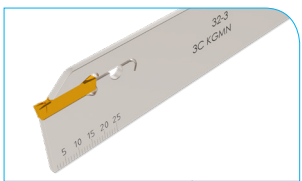
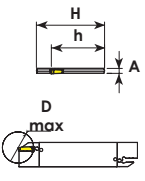
KGMN	Order Code	Product Code	Dimensions (mm)					Insert	Price
			H	h	A	L	D max		
	KL37	26-2	26	21,4	1,65	110	36	KGMN 200 KRLY	54 €
	KL38	26-3	26	21,4	2,45	110	36	KGMN 300 KRLY	54 €
	KL39	26-4	26	21,4	3,45	110	36	KGMN 400 KRLY	54 €
	KL34	32-2	32	25	1,65	150	36	KGMN 200 KRLY	57 €
	KL35	32-3	32	25	2,45	150	36	KGMN 300 KRLY	57 €
	KL36	32-4	32	25	3,45	150	36	KGMN 400 KRLY	57 €

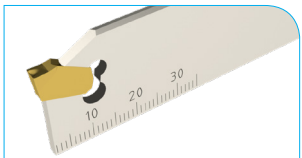
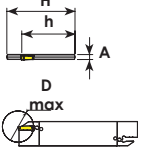
SP	Order Code	Product Code	Dimensions (mm)					Insert	Price
			H	h	A	L	D max		
	KL40	26-3	26	21,4	2,45	110		SP 300 KRLY	54 €
	KL42	26-4	26	21,4	3,45	110		SP 400 KRLY	54 €
	KL44	32-3	32	25	2,45	150		SP 300 KRLY	57 €
	KL45	32-4	32	25	3,45	150		SP 400 KRLY	57 €

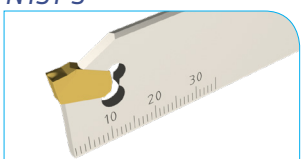
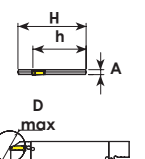
N151-3	Order Code	Product Code	Dimensions (mm)					Insert	Price
			H	h	A	L	D max		
	KL52	26-3	26	21,4	2,45	110		N151-3 SDV	54 €
	KL54	26-4	26	21,4	3,45	110		N151-4 SDV	54 €
	KL56	32-3	32	25	2,45	150		N151-3 SDV	57 €
	KL58	32-4	32	25	3,45	150		N151-4 SDV	57 €

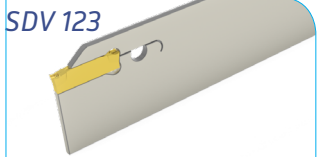
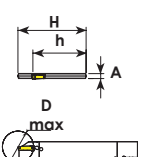
SDV 123	Order Code	Product Code	Dimensions (mm)					Insert	Price
			H	h	A	L	D max		
	KL60	32-3	32	25	2,45	150		123 3C SDV	57 €
	KL61	32-4	32	25	3,45	150		123 4C SDV	57 €

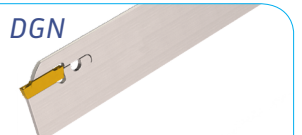
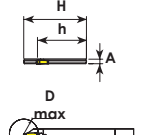
DGN	Order Code	Product Code	Dimensions (mm)					Insert	Price
			H	h	A	L	D max		
	KL20	32-3	32	25	2,45	150	36	DGN3	57 €
	KL22	32-4	32	25	3,45	150	36	DGN4	57 €

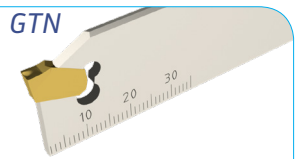
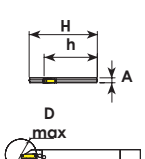
GTN	Order Code	Product Code	Dimensions (mm)					Insert	Price
			H	h	A	L	D max		
	KL23	26-3	26	21,4	2,45	110		GTN3	54 €
	KL24	26-4	26	21,4	3,45	110		GTN4	54 €
	KL25	32-3	32	25	2,45	150		GTN3	57 €
	KL26	32-4	32	25	3,45	150		GTN4	57 €

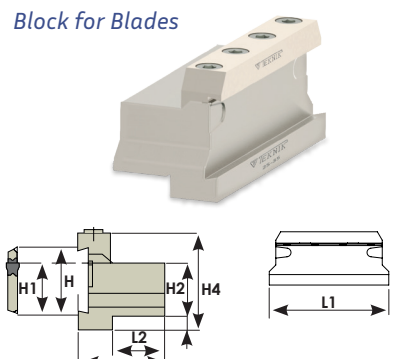
Block for Blades	Order Code	Product Code	Dimensions (mm)					Price	
			H	L1	L2	H1	H2		L3
	KLT04	20-26	26	87	19	21,4	20	33	88 €
	KLT05	25-26	26	110	20	24,4	25	34	94 €
	KLT06	20-32	32	110	19	25	20	35	88 €
	KLT08	25-32	32	110	20	25	25	36	94 €
	KLT10	32-32	32	110	28	25	32	44	99 €

## Grooving Holders



[www.teknikcuttingtools.com](http://www.teknikcuttingtools.com)



Kalite için TEKNİK çözüm  
Technical solution for quality

148-151



**KRLY/R**

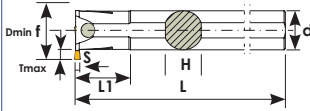

Order Code	Product Code	Dimensions (mm)									Insert	Price
		Dmin	Tmax	L	L1	d	h	f	s			
K600	S16Q 2C-R MGM	21	5	180	35	16	15	12,5	2	0,288	MGM 200	45 €
K602	S20Q 2C-R MGM	26	5,7	180	35	20	18	15,5	2	0,440	KRLY	51 €
K603	S25R 2C-R MGM	31	5,7	200	35	25	23	18	2	0,787		55 €
K604	S20Q 3C-R MGM	26	6	180	35	20	18	15,5	3	0,450		51 €
K606	S25R 3C-R MGM	32	6,7	200	40	25	23	19	3	0,784	MGM 300	55 €
K608	S32S 3C-R MGM	38	6,1	250	60	32	30	21,5	3	1,555	KRLY	62 €
K609	S40T 3C-R MGM	48	7,2	300	60	40	38	27	3	2,940		76 €
K610	S20Q 4C-R MGM	26	6	180	35	20	18	15,5	4	0,443		51 €
K612	S25R 4C-R MGM	31	6	200	40	25	23	18,2	4	0,783	MGM 400	55 €
K614	S32S 4C-R MGM	38	6	250	65	32	30	21,5	4	1,552	KRLY	62 €
K616	S40T 4C-R MGM	47	7,2	300	60	40	38	27	4	2,942		76 €
K618	S25R 5C-R MGM	32	7	200	40	25	23	19,2	5	0,777	MGM 500	55 €
K620	S32S 5C-R MGM	39	7	250	60	32	30	22,5	5	1,561	KRLY	62 €
K622	S40T 5C-R MGM	47	7,4	300	60	40	38	27	5	2,936		76 €

Code			
K600-K602,K604,K610	TC130 M5x12	4 Allen	
K603,K606,K612,K618	TC131 M5x16	5 Allen	
K608-K609,K614-K616,K620-K622	TC134 M6x20	5 Allen	

Compatible with KRLY insert. / Kompatibel für KRLY WP

**KGMN**

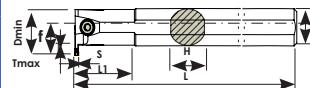

Order Code	Product Code	Dimensions (mm)									Insert	Price
		Dmin	Tmax	L	L1	d	h	f	s			
K660	S16K 2C KGMN	23	6,5	125	35	16	15	14	2	0,220	KGMN 200	45 €
K661	S20M 2C KGMN	25	6,5	150	45	20	18	15,5	2	0,374	KRLY	51 €
K662	S25R 2C KGMN	32	7	200	45	25	23	19	2	0,802		55 €
K663	S20M 3C KGMN	25	6,5	150	45	20	18	15,5	3	0,370	KGMN 300	51 €
K664	S25R 3C KGMN	32	7	200	45	25	23	19	3	0,800	KRLY	55 €
K665	S32S 3C KGMN	40	7,5	250	55	32	30	22,5	3	1,627		62 €
K666	S20M 4C KGMN	25	6,5	150	45	20	18	15,5	4	0,374	KGMN 400	51 €
K667	S25R 4C KGMN	32	7	200	45	25	23	19	4	0,796	KRLY	55 €
K668	S32S 4C KGMN	40	7,5	250	55	32	30	22,5	4	1,623		62 €

Code			
K660-K661,K663,K666	TC130 M5x12	4 Allen	
K662,K664,K667	TC131 M5x16	5 Allen	
K665,K668	TC134 M6x20	5 Allen	

Compatible with KRLY insert. / Kompatibel für KRLY WP

**HRN/R S229**

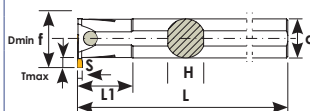
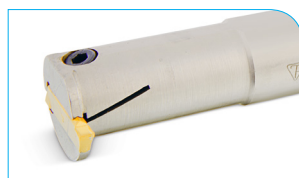

Order Code	Product Code	Dimensions (mm)									Insert	Price
		Dmin	Tmax	L	L1	d	h	f	s			
K624	S25R 3C-R S229	34	9,8	200	50	25	23	21,5	3	0,766	3C S229	55 €
K626	S32S 3C-R S229	41	9	250	50	32	30	24,5	3	1,560	B.HRN	62 €
K628	S40T 3C-R S229	49	9	300	50	40	38	21,5	3	2,594		76 €
K630	S25R 4C-R S229	34	9,8	200	50	25	23	24,5	4	0,768	4C S229	55 €
K632	S32S 4C-R S229	42	9	250	50	32	30	23,5	4	1,656	B.HRN	62 €
K634	S40T 4C-R S229	49	9	300	50	40	38	28,5	4	3,113		76 €
K636	S25R 5C-R S229	33	9,5	200	50	25	23	21	5	0,770	5C S229	55 €
K638	S32S 5C-R S229	41	9	250	50	32	30	24,5	5	1,659	B.HRN	62 €
K640	S40T 5C-R S229	49	9	300	50	40	38	28,5	5	3,109		76 €

Code			
K624,K630,K636	TC131 M5x20	4 Allen	
K626-K628,K632-K634,K638-K640	TC134 M6x20	5 Allen	

Compatible with HRN insert. / Kompatibel für HRN WP

**SDV/R 123**

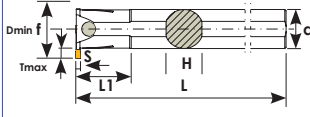
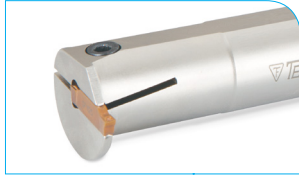

Order Code	Product Code	Dimensions (mm)										Insert	Price
		Dmin	Tmax	L	L1	d	h	f	s				
K720	S25R 3C-R-123 SDV	32	7	200	40	25	23	19,5	3	0,784	123 3C	55 €	
K722	S32S 3C-R-123 SDV	39	7	250	60	32	30	23	3	1,567	SNDVK	62 €	
K726	S25R 4C-R-123 SDV	32	7	200	40	25	23	19,5	4	0,772	123 4C	55 €	
K728	S32S 4C-R-123 SDV	39	7	250	60	32	30	23	4	2,854	SNDVK	62 €	
K730	S25S 5C-R-123 SDV	32	7	200	40	25	23	19,5	5	0,785	123 5C	55 €	
K732	S32S 5C-R-123 SDV	39	7	250	60	32	30	19,5	5	1,564	SNDVK	62 €	
<b>Code</b>													
K720,K726,K730		TC131 M5x16		4 Allen									
K722-K728,K732		TC134 M6x20		5 Allen									

Compatible with SNDVK insert. / Kompatibel für SNDVK WP

**HRN/R S224**

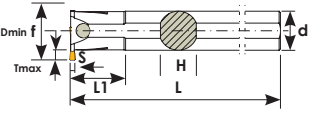
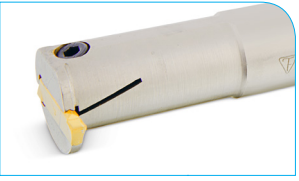

Order Code	Product Code	Dimensions (mm)										Insert	Price
		Dmin	Tmax	L	L1	d	h	f	s				
K642	S20Q 2C-R S224	26	6,5	180	40	20	18	16	2	0,444	2C S224	51 €	
K644	S25R 2C-R S224	34	9	200	50	25	23	21	2	0,763	K.HRN	55 €	
K646	S20Q 3C-R S224	26	6,5	180	40	20	18	16	3	0,459	3C S224	51 €	
K648	S25R 3C-R S224	33	9	200	50	25	23	20,5	3	0,782	K.HRN	55 €	
K650	S32S 3C-R S224	40	9	250	50	32	30	24	3	1,633		62 €	
K652	S20Q 4C-R S224	26	6,5	180	40	20	18	16	4	0,440	4C S224	51 €	
K654	S25R 4C-R S224	33	9	200	50	25	23	20,5	4	0,764	K.HRN	55 €	
K656	S32S 4C-R S224	42	9	250	50	32	30	23,5	4	1,672		62 €	
<b>Code</b>													
K642,K646,K652		TC130 M5x12		4 Allen									
K644,K648,K654		TC131 M5x16		5 Allen									
K650,K656		TC134 M6x20											

Compatible with HRN insert. / Kompatibel für HRN WP

**ZCC/R ZT.D**

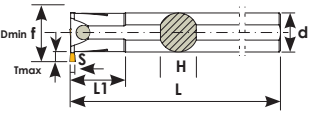

Order Code	Product Code	Dimensions (mm)										Insert	Price
		Dmin	Tmax	L	L1	d	h	f	s				
K679	S16Q 2C-R ZT.D	20	4,9	180	35	16	15	12,5	2	0,446	ZT.D 2C ZCC	45 €	
K680	S20Q 3C-R ZT.D	26	5,5	180	35	20	18	15	3	0,661	ZT.D 3C	51 €	
K681	S25R 3C-R ZT.D	33	7,5	200	35	25	23	20	3	1,576	ZCC	55 €	
K682	S32S 3C-R ZT.D	39	7	250	50	32	30	23	3	1,641		62 €	
K684	S25R 4C-R ZT.D	33	7,5	200	35	25	23	20	4	1,578	ZT.D 4C	55 €	
K685	S32S 4C-R ZT.D	39	7	250	50	32	30	23	4	1,645	ZCC	62 €	
<b>Code</b>													
K679,K680		TC130 M5x12		4 Allen									
K681,K684		TC131 M5x16		5 Allen									
K682-K685		TC134 M6x20											

Compatible with ZCC insert. / Kompatibel für ZCC WP

**DGN/R**

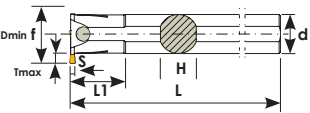

Sipariş Kodu	Ürün Kodu	Ölçüler (mm)										Uç	Fiyat
		Dmin	Tmax	L	L1	d	h	f	s				
K672	S20Q 3C-R DGN	25	5,5	180	35	20	18	15,0	3	0,308	DGN 3C	51 €	
K673	S25R 3C-R DGN	31	6	200	40	25	23	18,5	3	0,463	ISCR	55 €	
K674	S32S 3C-R DGN	37	6	250	55	32	30	30	3	0,809		62 €	
K676	S20Q 4C-R DGN	25	5,5	180	35	20	18	18	4	0,463	DGN 4C	51 €	
K677	S25R 4C-R DGN	31	6	200	40	25	23	23	4	0,810	ISCR	55 €	
K678	S32S 4C-R DGN	37	6	250	55	32	30	30	4	1,655		62 €	
<b>Kod</b>													
K672,K676		TC130 M5x12		4 Allen									
K673,K677		TC131 M5x16		5 Allen									
K674-K678		TC134 M6x20											

ISCR Uclarına uygundur.

GRP/R

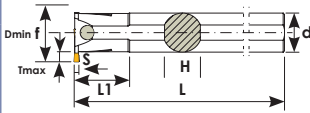
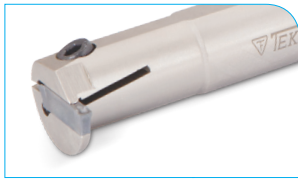

Order Code	Product Code	Dimensions (mm)										Insert	Price
		Dmin	Tmax	L	L1	d	h	f	s				
K700	S16Q 3C-R GRP	21	4,9	180	45	16	18	12,5	3	0,308	GRP 3C	45 €	
K702	S20Q 3C-R GRP	26	6	180	35	20	18	15,7	3	0,463	ISCR	51 €	
K704	S25R 3C-R GRP	32	6,5	200	35	25	23	18,7	3	0,809		55 €	
K706	S20Q 4C-R GRP	26	5,5	180	35	20	18	15,2	4	0,463	GRP 4C	51 €	
K708	S25R 4C-R GRP	32	6,5	200	35	25	23	18,7	4	0,810	ISCR	55 €	
K710	S32S 4C-R GRP	38	6,5	250	60	32	30	22	4	1,655		62 €	

Code			
K700,K702,K706,K708	TC130 M5x12	4 Allen	
K704,K708	TC131 M5x16	5 Allen	
K710	TC134 M6x20		

Compatible with ISCR insert. / Kompatibel für ISCR WP

ISO 40

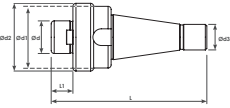

Order Code	Product Code	Şaft	Dimensions (mm)								Price
			d	d2	d1	d3	L	L1			
M206	ISO 40-16	ISO 40	16	54	38	25	154	17	1,232	61 €	
M208	ISO 40-22	ISO 40	22	54	50	25	154	19	1,371	61 €	
M210	ISO 40-27	ISO 40	27	55	59	25	154	21	1,413	61 €	
M212	ISO 40-32	ISO 40	32	61	67	25	154	24	1,750	61 €	
M214	ISO 40-40	ISO 40	40	61	73	25	154	27	1,956	61 €	

ISO 50

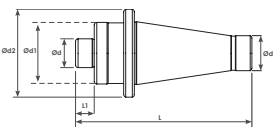

Order Code	Product Code	Şaft	Dimensions (mm)								Price
			d	d2	d1	d3	L	L1			
M216	ISO 50-22	ISO 50	22	98	52	39	196	19	3,640	97 €	
M218	ISO 50-27	ISO 50	27	98	61	39	196	21	3,976	97 €	
M220	ISO 50-32	ISO 50	32	98	68	39	196	24	3,817	97 €	
M222	ISO 50-40	ISO 50	40	98	98	39	196	27	4,512	97 €	
M224	ISO 50-60	ISO 50	60	108	108	39	196	26	5,562	97 €	

Mini Grooving Holders

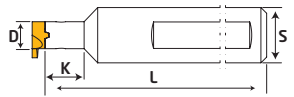

Order Code	Product Code	Dimensions (mm)					Insert	Price
		S	D	K	L	kg		
K801	S12 D5,9 K24 L080	12	5,9	24	80	0,143	NFTG 08 KRLY	61 €
K802	S12 D08 K33 L095	12	8	33	98	0,126	NFTG 11 KRLY	61 €
K803	S12 D09 K45 L110	12	9	45	110	0,120	NFTG 14 KRLY	61 €
K804	S12 D11 K48 L130	16	11	48	130	0,348	NFTG 16 KRLY	69 €

Code	
K801	TC063 M2,5x7
K802	TC069 M3,5x8,5
K803	TC074 M4x10
K804	TC085 M5x12

Compatible with KRLY insert. / Kompatibel für KRLY WP

Mini Grooving Holders

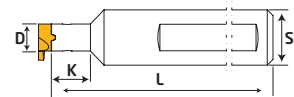

Order Code	Product Code	Dimensions (mm)					Insert	Price
		S	D	K	L	kg		
K810	S16 D08 K11 L093	16	8	11	93	0,098	D08	61 €
K812	S16 D09 K20 L093	16	9	20	93	0,102	D09	61 €
K814	S16 D06 K11 L081	16	6	11	81	0,082	D06	61 €
K816	S20 D14 K49 L160	20	14	49	160	0,367	D14	69 €

Code	
K810	TC069 M3,5x8,5
K812	TC074 M4x10
K814	TC063 M2,5x7
K816	TC085 M5x12

MINI TOOL

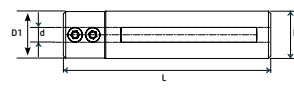
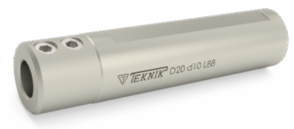

Order Code	Product Code	Dimensions (mm)					M6x50	M6x8	Price
		D	d	L	D1	kg			
DC304	D16 d03 L88	16	3	88	19,65	0,134	M6x50	M6x8	48 €
DC306	D20 d03 L88	20	3	88	19,65	0,228	M6x50	M6x8	48 €
DC310	D12 d04 L88	12	4	88	11,65	0,075	M6x50	M6x5	48 €
DC312	D16 d04 L75	16	4	75	19,65	0,139	M6x35	M6x8	48 €
DC314	D16 d04 L88	16	4	88	19,65	0,159	M6x50	M6x8	48 €
DC316	D20 d04 L88	20	4	88	19,65	0,222	M6x50	M6x8	48 €
DC318	D22 d04 L88	22	4	88	21,65	0,274	M6x50	M6x8	48 €
DC320	D12 d05 L88	12	5	88	11,65	0,067	M6x50	M6x5	48 €
DC322	D16 d05 L75	16	5	75	19,65	0,135	M6x35	M6x8	48 €
DC324	D16 d05 L88	16	5	88	19,65	0,153	M6x50	M6x8	48 €
DC326	D20 d05 L88	20	5	88	19,65	0,221	M6x50	M6x8	48 €
DC328	D22 d05 L88	22	5	88	21,65	0,274	M6x50	M6x8	48 €
DC334	D20 d06 L88	20	6	88	19,65	0,227	M6x50	M6x8	48 €
DC340	D20 d07 L88	20	7	88	19,65	0,219	M6x50	M6x8	48 €
DC344	D16 d08 L88	16	8	88	19,65	0,142	M6x50	M6x8	48 €
DC346	D20 d08 L88	20	8	88	19,65	0,214	M6x50	M6x5	48 €
DC350	D16 d10 L88	16	10	88	19,65	0,130	M6x50	M6x5	48 €
DC352	D20 d10 L88	20	10	88	19,65	0,201	M6x50	M6x5	48 €

Kalite için TEKNİK çözüm  
Technical solution for quality



[www.teknikcuttingtools.com](http://www.teknikcuttingtools.com)

We do all  
we can  
to meet  
customers  
expectations.





## Spare Parts



[www.teknikcuttingtools.com](http://www.teknikcuttingtools.com)









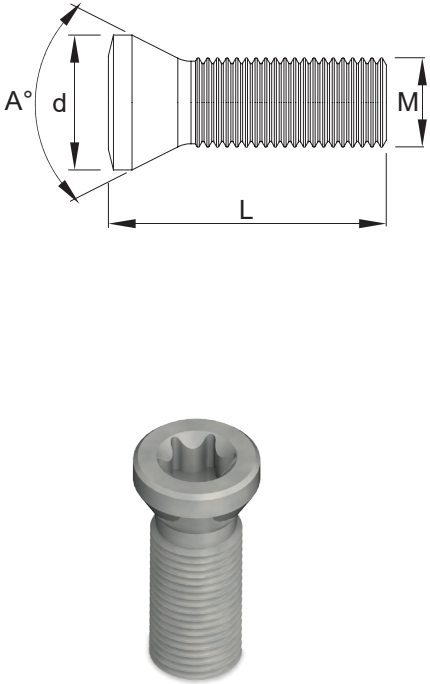
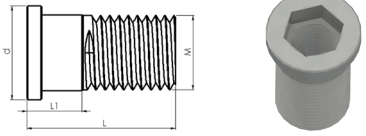

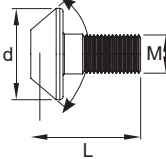
Kalite için TEKNİK çözüm  
Technical solution for quality

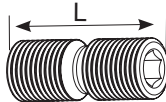

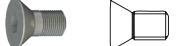



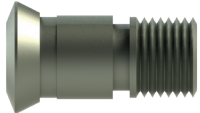

154-157

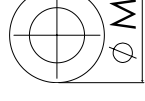

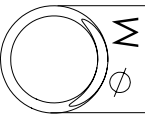

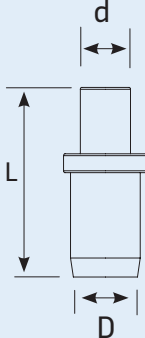

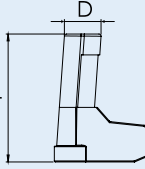

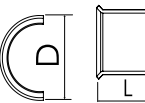

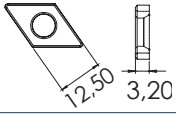

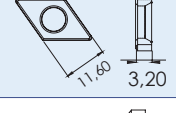

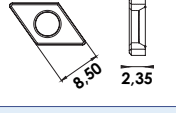



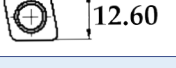
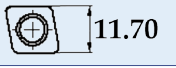

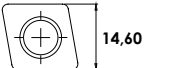
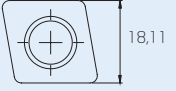

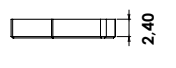

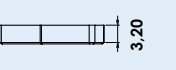

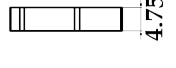



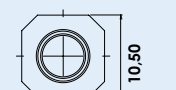



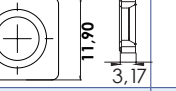

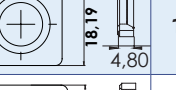

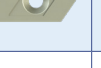
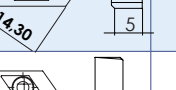



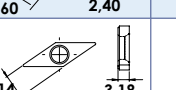

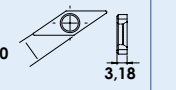

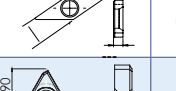

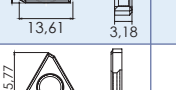

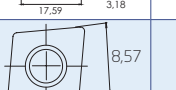

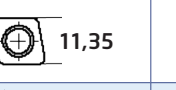

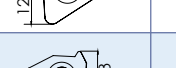

Part	Code	M	L	d	A	Key	Price
	TC057	M1,6	3,4	2,6	60°	T6	3,00 €
	TC057-1	M1,8	4,1	2,5	60°	T6	3,00 €
	TC058	M2	4,2	2,8	60°	T6	3,00 €
	TC058-1	M2	5	2,8	60°	T6	3,00 €
	TC058-2	M2,2	6	3	60°	T7	3,00 €
	TC059	M2,2	5	3	60°	T7	3,00 €
	TC059-1	M2,5	4,7	3,5	60°	T8	0,61 €
	TC060	M2,5	5,5	3,5	60°	T8	<b>0,61 €</b>
	TC061	M2,5	6,5	3,5	50°	T8	<b>0,61 €</b>
	TC063	M2,5	7	3,5	60°	T8	<b>0,61 €</b>
	TC092	M2,5	5,5	3,8	60°	T8	0,61 €
	TC093	M2,5	7	3,8	60°	T8	0,61 €
	TC064	M3	6,2	3,8	60°	T8	<b>0,61 €</b>
	TC065	M3	7	4,2	60°	T8	<b>0,61 €</b>
	TC065-1	M3	7	4	60°	T8	<b>0,61 €</b>
	TC066	M3	10	5,3	55°	T15	<b>0,61 €</b>
	TC067	M3,5	8,5	5,3	60°	T15	<b>0,61 €</b>
	TC068	M3,5	11	5,3	60°	T15	<b>0,61 €</b>
	TC069	M3,5	8,5	4,8	60°	T10	<b>0,61 €</b>
	TC071	M3,5	7	5,3	60°	T15	0,61 €
	TC072	M4	10	5,5	60°	T15	0,61 €
	TC073	M4	8,5	5,5	60°	T15	<b>0,61 €</b>
	TC074	M4	10	5,5	60°	T15	<b>0,61 €</b>
	TC075	M4	11	7	60°	T15	<b>0,61 €</b>
	TC076	M4	12,5	5,5	60°	T15	<b>0,61 €</b>
	TC077	M4	15	6,8	60°	T15	0,61 €
	TC078	M4	11	6,7	60°	T15	0,61 €
	TC079	M4	11	5,2	45°	T15	<b>0,61 €</b>
	TC080	M4,5	11	6,2	60°	T15	<b>0,61 €</b>
	TC083	M5	12	7	60°	T20	<b>0,61 €</b>
	TC085	M5	12	6,6	75°	T20	<b>0,61 €</b>
	TC086	M5	18	7,5	60°	T20	0,72 €
	TC048	M5	9	6,3		4 Allen	<b>2,75 €</b>
	TC049	M5	7,7			3,5 Allen	<b>2,75 €</b>
	TC049-1	M6	10			4 Allen	2,75 €

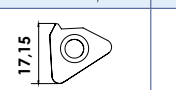
	Code	M	L	d	Key	Price
 	TC050	M6	14	11,2	3 Allen	0,94 €
	TC052	M6	17	14	4 Allen	0,94 €
	TC054	M8	24	17,1	5 Allen	0,94 €
	TC056	M8 (sol-left)	24	17,1	5 Allen	0,94 €
 	TC300	M8	21		4 Allen	3,85 €
 	TC044	M6	27	11	3 Allen	0,61 €
	TC046	M5	26	10	3 Allen	0,61 €
	TC047	M8	29	13,6	5 Allen	2,42 €
 	TH512	M5	12		2 Allen	4,51 €
	TH613	M6	13,4		2,5 Allen	4,51 €
	TH617	M6	17		2 Allen	4,51 €
	TH818	M8	18		3 Allen	4,51 €
	TH821	M8	21		3 Allen	4,51 €
	TH822	M8	22		2,5 Allen	4,51 €
	TH825	M8	25		3 Allen	4,51 €
	TC036	M3	10	5,6	T10	0,61 €
	TC038	M4	10	7,30	T15	0,61 €
	TC039	M6	12	10,6	4 Allen	0,61 €
	TC040	M3,5	10	8	T15	0,61 €
	TC062	M3	6,7	5,5	T15	0,61 €
	TC053	M4	9	6,5	T20	0,61 €
	TC053-1	M4	9	6,5	T15	0,61 €
	TC095	M5	12	9,5	3 Allen	0,61 €
 	TC170	M3	7	4,2	T8	1,21 €
	TC172	M4	9	5,8	T15	1,21 €
	TC174	M5	10	7	T20	1,21 €
	TC176	M5	12	7,3	T20	1,21 €
	TC178	M5	16	7,8	3 Allen	1,21 €
	TC181	M6	22	9,5	3 Allen	4,51 €
	TC184	M8	25	13	4 Allen	4,51 €

Code	Type	Part	Dimensions (mm)	Price
			M	
BK017	DNMG 11			5,78 €
BK017-1	TNMG 16			5,78 €
BK018	CNMG 16			7,15 €
BK019	WNMG 06			5,78 €
BK020	DNMG 15 CNMG 12 SNMG 12			5,78 €
BK021	VNMG 16			5,78 €
BK022	TNMG 16			5,78 €
BK023	TNMG 22			5,78 €
BK024	DNMG 11 (Small)			5,78 €
BK025	CNMG 19			5,78 €
BK027	SNMG 25			7,15 €
BK026	WNMG 08			5,78 €
BK028	KNUX Sağ/ Right			6,33 €
BK030	KNUX/Left			6,33 €
BK035	RDMT 16			5,39 €
BK036	TPKN16			5,39 €
BK300	OFCR 07			5,78 €

Code	Type	Part	Dimensions (mm)	Price	
			M		
BSP010	Washer			0,42 €	
BSP030	Washer (Normal)			0,42 €	
BSP031	Washer			0,42 €	
BSP032	Washer			0,42 €	
BY040	M6			0,42 €	
BY041	M5			0,42 €	
BY042	M6			0,42 €	
BY043	M5			0,42 €	
BY044				0,42 €	
BSP020	TNMG 16 WNMG 06	D:5 d:3,5 L:14,5			2,48 €
BSP021	TNMG 22 DNMG 11 WNMG 08	D:6 d:5 L:15			2,48 €
TL3	L12,2-D3,5			7,70 €	
TL3B	L10-D3			7,70 €	
TL4	L13-D4,5			7,70 €	
TL4A	L10,5-D4,7			7,70 €	
TL4B	L15,6-D5			7,70 €	
TS-3	D6,65-L5,5				
TS-4	D7,71-L7	2,48 €			

Code	Type	Part	Dimensions (mm)	Price
			M	
TA014	DNMG 15 Shim			6,60 €
TA014-1	DNMG 15 Shim			6,60 €
TA013	DNMG 11 Shim			6,05 €
TA023	CNMG 09 Shim			6,60 €
TA016	CNMG 12 Shim			6,60 €
TA016-1	CNMG 12 Shim			6,60 €
TA022	CNMG 16 Shim			9,35 €
TA017	CNMG 19 Shim			10,45 €
TA021	WNMG 06 Shim			6,05 €
TA020-1	WNMG 08 Shim			6,60 €
TA020	WNMG 08 Shim			7,70 €
TA019	TNMG 16 Shim			6,60 €
TA045	TNMG 22 Shim			7,70 €
TA052	SEET 12 Shim			6,05 €

Code	Type	Part	Dimensions (mm)	Price
			M	
TA050	SNMG 12 Shim			6,60 €
TA051	SNMG 19 Shim			10,45 €
TA053	SNMG 25 Shim			12,10 €
TA046	KNUX RIGHT Shim			5,78 €
TA048	KNUX LEFT Shim			5,78 €
TA030	DCMT 11 Shim			5,50 €
TA034	VBMT 16 Shim			6,60 €
TA032	VCMT 16 Shim			6,60 €
TA033	VNMG 16 Shim			6,60 €
TA010	TPKN 16 Shim			5,50 €
TA012	TPKN 22 Shim			5,61 €
TA015	CCMT 09 Shim			5,50 €
TA015-1	CCMT 12 Shim			5,50 €
TA040	ER 16 Shim			5,50 €
TA061	16 ER Shim			6,60 €
TA060	16 IR Shim			6,60 €
TA062	22 ER Shim			7,70 €
TA063	22 IR Shim			7,70 €
TA064	27 ER Shim			9,35 €
TA065	27 IR Shim			9,35 €

S 32 T D D U N R 15

1	2	3	4	5	6	7	8	9		
Type of Shank Schaftansführung	Shank Schaft	Tool Length Werkzeuglänge	Clamping System Klemmsystem	Insert Form WSP-Form	Tool Type Shank Werkzeugtyp	Insert Clear- ance WSP-Freiwinkel	Holder Ex- ecution Bearbestungs- richtung	Cutting Edge WSP- Grösse		
A: Çelik Gövdeli içten Sogutmalı Coolan Through Steel Shank Mit Kühlbohrung	 (mm)	 (mm)	 D  M  P  S	A  F B  L C  Q D  S E  U H  W K  Z L  X M O P R S T V W	X = ÖZEL Special Sonderform			A B C D E K L M O P R S T V W		
									06 = 6	D = 60
									08 = 8	E = 70
									10 = 10	F = 80
									12 = 12	G = 90
									14 = 14	H = 100
									16 = 16	J = 110
									20 = 20	K = 125
									22 = 22	L = 140
									25 = 25	M = 150
32 = 32	N = 160									
40 = 40	P = 170									
50 = 50	Q = 180									
C: Toz Metal Gövdeli Hardmetal Shank Hartmetall Stahlkopf										
									R = 200	
									S = 250	
									T = 300	
									U = 350	
E: Toz Metal Gövdeli içten Sogutmalı Hardmetal Shank With Coolant Hole Hartmetall Schaftmit Stahlkopf und Kühlbohrung										
									V = 400	
									W = 450	
									Y = 500	
									X = ÖZEL Special Sonderform	
S: Çelik Gövdeli Steel Shank Stahl Schaft										

**D**

**D**

**J**

**N**

**R**

**20**

**20**

**K**

**15**

1	2	3	4	5	6	7	8	9
Clamping System Klemmsystem	Cutting Style Plattenform	Type Werkzeugtyp	Clearance angle WSP-Freiwinkel	Holder Execution Bearbeitungsrichtung	Height of Shank Schaftquerschnitts	Width of Shank Schaftbreite	Leng of Holder Werkzeuglänge	Leng of Holder Werkzeuglänge
<p><b>D</b></p> <p><b>M</b></p> <p><b>P</b></p> <p><b>S</b></p>	<p>A </p> <p>B </p> <p>C </p> <p>D </p> <p>E </p> <p>H </p> <p>K </p> <p>L </p> <p>M </p> <p>O </p> <p>P </p> <p>R </p> <p>S </p> <p>T </p> <p>V </p> <p>W </p>	<p>A </p> <p>B </p> <p>C </p> <p>D </p> <p>E </p> <p>F </p> <p>G </p> <p>J </p> <p>K </p> <p>L </p> <p>N </p> <p>P </p> <p>Q </p> <p>R </p> <p>S </p> <p>V </p>	<p>A </p> <p>B </p> <p>C </p> <p>D </p> <p>E </p> <p>F </p> <p>G </p> <p>P </p> <p>N </p> <p>O </p>	<p><b>L</b></p> <p><b>R</b></p> <p><b>N</b></p>	<p>(mm)</p> <p>06 = 6</p> <p>08 = 8</p> <p>10 = 10</p> <p>12 = 12</p> <p>14 = 14</p> <p>16 = 16</p> <p>20 = 20</p> <p>22 = 22</p> <p>25 = 25</p> <p>32 = 32</p> <p>40 = 40</p> <p>50 = 50</p>	<p>(mm)</p> <p>06 = 6</p> <p>08 = 8</p> <p>10 = 10</p> <p>12 = 12</p> <p>14 = 14</p> <p>16 = 16</p> <p>20 = 20</p> <p>22 = 22</p> <p>25 = 25</p> <p>32 = 32</p> <p>40 = 40</p> <p>50 = 50</p>	<p>(mm)</p> <p>D = 60</p> <p>E = 70</p> <p>F = 80</p> <p>G = 90</p> <p>H = 100</p> <p>J = 110</p> <p>K = 125</p> <p>L = 140</p> <p>M = 150</p> <p>N = 160</p> <p>P = 170</p> <p>Q = 180</p> <p>R = 200</p> <p>S = 250</p> <p>T = 300</p> <p>U = 350</p> <p>V = 400</p> <p>W = 450</p> <p>Y = 500</p> <p>X = ÖZEL Special Sonderform</p>	<p>A (mm) </p> <p>B </p> <p>C </p> <p>D </p> <p>E </p> <p>K </p> <p>L </p> <p>M </p> <p>O </p> <p>P </p> <p>R </p> <p>S </p> <p>T </p> <p>V </p> <p>W </p>







